

Statligt Ramavtal - Möbler och inredning

Delområde – Möbler för möten & paus (B)



Profim – Produktlista nr 1



Addentity Interiör AB
Östra Rönneholmsvägen 5
211 47 Malmö

Telefon: 0733-335020
avropa@addentityinterior.se

Org.nummer: 556839-3416
Avtalsnummer: 233-5834-2022-008

26% rabatt ska dras av på angivna priser

Contents

Profim MICKEY

Profim TRILLO PRO

Visitor chairs

Profim ANA

Profim ARIZ

Profim BIT

Profim COM

Profim NOOR 4-LEG

Profim NOOR SLEDGEBASE Profim

NOOR FOOTBASE

Profim NOOR WOODEN LEGS

Profim NOOR UP

Profim NORMO

Profim ZOO

Sofas, armchairs, modular systems

Profim CHIC

Profim CHIC LOUNGE

Profim ELLIE PRO

Profim FAN

Profim NU

Profim REVO

Profim SORRISO

Profim VANCOUVER LITE

Profim VANCOUVER OTO

Profim WALL IN

Tables, coat stands and accessories

Profim ALLROUND

Profim EMINENT

Profim REVO TABLES

Profim STANDARD FOLDING TABLE

Profim U-CONNECT

Profim SEVEN

Profim CUSHION

Technical details

Terms of guarantee

Fabrics and finishings

Profim Standard fabrics

Fabrics and finishings - Extended

26% rabatt ska dras av på angivna priser

Armchairs

Swivel chairs

Pouffes

26% rabatt ska dras av på angivna priser

Profim MICKEY

ITO Design

- It is a unique combination of a pouffe and a swivel stool with height adjustment
- Totally intuitive and easy to use
- Provides support by tilting from side to side (range of 10 degrees in each direction)
- Three colours of plastic parts
- Möbelfakta certificate - a guarantee of durability, safety, environmental care and social responsibility during the production process

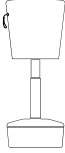
Item no	Base model +	Price Group (PG)	Price Group						Price
			0	①	②	③	④	⑤	
MMC0000000	Profim MICKEY <ul style="list-style-type: none">• stool, swivel with height adjustment and sideways tilt 10°• base: lightgrey (RAL 7047) / grey (RAL 7043) / beige (RAL 7036)		3 612	3 763	4 139	4 327	4 513	5 266	6 337

0 price group: Evo

1 price group: Cura, Tonal, Xtreme

2 price group: Select

3 price group: Capture, Oceanic, Step, Synergy

4 price group: Steelcut 3, Steelcut Trio 3

Base: lightgrey (RAL 7047) / grey (RAL 7043) / beige (RAL 7036) - when ordering please clearly indicate the chosen option.

Glides:

- teflon glides - universal (set).

When ordering please clearly indicate the chosen option.

The sides of the base can be made of:

- the same fabric as the seat,

- plastic in the same colour as the rest of plastic elements.

Please clearly indicate on your order the chosen option.

Handle for height adjustment is always made of the same fabric as the rest of the seat.

Plastic elements and the cover of the gas lift are made of different materials therefore their colour might vary slightly.





26% rabatt ska dras av på angivna priser

Profim TRILLO PRO

ITO Design

- Easily adjustable basic functions.
- Synchro self mechanism ensures adjustment to user's weight,
- Several versions to choose from: backrest in plastic or with upholstered pad, plastics in two colours,
- Blue Angel certificate - confirms that our chair is environmentally friendly

Item no	Base model +	Price Group (PG)	0	①	②	③	④	⑤	Price
MSX200HS00	Profim TRILLO PRO 20HST <ul style="list-style-type: none"> • plastic backrest • self mechanism • 4-star base, high • base: black / white / graphite / polished aluminum / MetallicPro 		3 670	3 918	4 047	4 201	4 449	4 696	
MSX210HS00	Profim TRILLO PRO 21HST <ul style="list-style-type: none"> • plastic backrest with upholstered pad • self mechanism • 4-star base, high • base: black / white / graphite / polished aluminum / MetallicPro 		4 154	4 519	4 767	4 956	5 546	5 522	

0 price group: Evo

1 price group: Cura, Tonal, Xtreme

2 price group: Select

3 price group: Capture, Oceanic, Step, Synergy

4 price group: Steelcut 3, Steelcut Trio 3

Castors/glides:

- hard castors - for soft floors (set),
- soft castors - for hard floors (set),

Plastic colours:- black, grey (RAL 7043), light grey (RAL 7047).

Plastic elements: backrest and armrests.

In models 20HST / 21HST:

- base colour black / MetallicPro - plastic elements black, castors black,
- base colour white - plastic elements lightgrey (RAL 7047), castors lightgrey,
- base colour graphite - plastic elements black or grey (RAL 7043), castors black,
- base colour polished aluminium - plastic elements black, grey (RAL 7043) and castors black or plastic elements light grey (RAL 7047) and castors lightgrey.

Please clearly indicate on your order the chosen option.



26% rabatt ska dras av på angivna priser

Visitor chairs



26% rabatt ska dras av på angivna priser

26% rabatt ska dras av på angivna priser

Profim Ana

Tias Eckhoff

- Polypropylene (PP) shell in various colours.

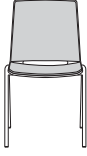
Item no	Base model +	Price Group (PG)	0	①	②	③	④	⑤	Price
4340	Profim Ana 4340 • Without upholstery								720
4340s	Profim Ana 4340S • Upholstered seat		1 153	1 158	1 214	1 364	1 559	1 755	
4340sr	Profim Ana 4340SR • Upholstered seat and back		1 507	1 543	1 586	1 898	2 316	2 650	
Accessories/Options/Surcharges:									
M400-1/2/3/4	Writing tablet in 12 mm beech or birch veneer. Right/left								1 044
	Linking device, welded. Must be specified at time of order. Can not be retrofitted. Please observe that chairs with linking device manufactured before January 2021 are not compatible with the current version								120
RS091016	Plastic link, black, detachable								34
RS092031	Felt glides for hard floors, front legs, per unit								10
RS092032	Felt glides for hard floors, back legs, per unit								10
149285	Chair trolley								3 662

0 price group: Evo

1 price group: Cura, Tonal, Xtreme

2 price group: Select

3 price group: Capture, Oceanic, Step, Synergy

4 price group: Steelcut 3, Steelcut Trio 3

Frame of 19 x 1.5 mm tubular steel available in various colours.

Weight 3.7 kg model 4340

Height: Seat 430 mm, Back 400 mm, Chair width 490 mm, Chair height 825 mm, Chair depth 515 mm

Stackable up to 12 chairs without upholstery (height: 1.83 m), 10 chairs with seat upholstery (height: 1.65 m) and 7 chairs with seat and back upholstery

Can be linked together using linking device - see options

Table suspension Profim Ana. See Profim Eminent table

Graphite shell colour in recycled PP

26% rabatt ska dras av på angivna priser



S=Standard Collection – normal delivery time from factory 10-15 working days. Applicable when all component options (fabric, shell, frame/legs) are standard (S).

E=Extended Collection – normal delivery time from factory 20-30 working days. Applicable when any or all component options selected are extended (E).







For larger orders, please contact Customer Service for delivery details.







26% rabatt ska dras av på angivna priser

Profim ARIZ

- Wide configuration possibilities with several plastic colours and a wide range of upholstery fabrics
- Plastic, upholstered, and mesh versions.
- Version with comfortable armrest available
- Possibility of high stacking (up to 45 pieces on a special trolley for chair transport)
- Option to join in rows, mount writing top and newspaper basket
- Möbelfakta certificate - a guarantee of durability, safety, environmental care and social responsibility during the production process

Item no	Base model +	Price Group (PG)	0	①	②	③	④	⑤	Price
MWE500V000	Profim ARIZ 550V • plastic seat and backrest • frame: black								1723
MWE550V000	Profim ARIZ 555V • plastic seat • mesh backrest • frame: black								2053
MWE600V000	Profim ARIZ 560V • upholstered seat • plastic backrest • frame: black		1947	2077	2183	2266	2466	2537	
MWE700V000	Profim ARIZ 570V • upholstered seat and backrest • frame: black		2313	2549	2915	3033	3788	3375	
MWE750V000	Profim ARIZ 575V • upholstered seat • mesh backrest • frame: black		2325	2466	2561	2655	2867	2974	
MWE500CV00	Profim ARIZ 550CV • bar stool • plastic seat and backrest • frame: black								2395

26% rabatt ska dras av på angivna priser

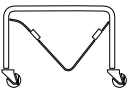
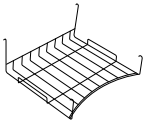
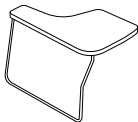
Item no	Base model +	Price Group (PG)	0	①	②	③	④	⑤	Price
MWE550CV00	Profim ARIZ 555CV • bar stool • plastic seat • mesh backrest • frame: black								2643
MWE600CV00	Profim ARIZ 560CV • bar stool • upholstered seat • plastic backrest • frame: black		2584	2738	2867	2974	3151	3328	
MWE700CV00	Profim ARIZ 570CV • bar stool • upholstered seat and backrest • frame: black		2950	3221	3587	3729	4460	4154	
MWE750CV00	Profim ARIZ 575CV • bar stool • upholstered seat • mesh backrest • frame: black		2962	3139	3233	3363	3540	3741	
MWE000W000	Profim ARIZ Chairs' trolley (W)								3552
MPDWEKO000	Profim ARIZ Newspapers bin (K)								425
MPDWEBL000	Profim ARIZ Table top (B)								1333

26% rabatt ska dras av på angivna priser

Accessories/Options/Surcharges:

7COPR002	Frames colours: MetallicPro, White RAL 9016, Deep Green RAL 6004, Navy Blue RAL 5003, Burgundy RAL 3005, Salvia/Green RAL 6021, Blue RAL 5014, Terracota RAL 3012 (Only for: 550CV, 550V, 555CV, 555V, 560CV, 560V, 570CV, 570V, 575CV, 575V)	35
7COPR003	Frames colours: Lightgrey NCS S 2500-N; Grey NCS S 6500-N (Only for: 550CV, 555CV, 555V, 560CV, 560V, 570CV, 570V, 575CV, 575V)	212
7COPR003	Frames colours: Lightgrey NCS S 2500-N; Grey NCS S 6500-N (Only for: 550V)	1593
7ARMR001	Armrests - metal, polypropylene pad (set) (Only for: 550V, 555V, 560V, 570V, 575V)	767

0 price group: Evo

1 price group: Cura, Tonal, Xtreme

2 price group: Select

3 price group: Capture, Oceanic, Step, Synergy

4 price group: Steelcut 3, Steelcut Trio 3

Glides:

- standard - teflon glides (universal),
- option - felt glides (for hard floors).

When ordering please clearly indicate the chosen option.

Colours of plastics:

black (CODE 01), white (CODE 20), gray blue (CODE 503), olive green (CODE 513), red (CODE 3020), navy (CODE 516), ashen (CODE 517).

In models Ariz 555/575 backrest frame only in colours: black, white and ashen.

Available versions with mesh backrest (in Ariz 555 model):

- black plastic seat (CODE 01) + black backrest frame (CODE 01) + black mesh,
- white plastic seat (CODE 20) + white backrest frame (CODE 20) + black mesh,
- ashen plastic seat (CODE 517) + ashen backrest frame (CODE 517) + black mesh.

In standard there is no option of different colours of backrest and seat.

Type of mesh: GZ.

Accessories only for 550V / 555V / 560V / 570V / 575V models:

- Chairs' trolley - frame colour is always black.
- Table top (B) - assembled on the left or right hand, available in chairs without armrests only, table top's frame colour is always chrome.
- Newspapers bin (K) - mounted under the seat, colour is always chrome.



26% rabatt ska dras av på angivna priser

Profim BIT

- Cantilever- or leg-mounted version
- Stackable
- Option to join in rows
- Choice of plastic or upholstered seat and plastic, mesh or upholstered backrest

Item no	Base model +	Price Group (PG)	0	①	②	③	④	⑤	Price
MBT500H000	Profim BIT 550H • 4-legged • plastic seat and backrest • frame: black								1723
MBT500V000	Profim BIT 550V • cantilever • plastic seat and backrest • frame: black								2183
MBT550H000	Profim BIT 555H • 4-legged • plastic seat • mesh backrest • frame: black								2124
MBT550V000	Profim BIT 555V • cantilever • plastic seat • mesh backrest • frame: black								2513
MBT600H000	Profim BIT 560H • 4-legged • seat upholstered pad • plastic backrest • frame: black		2 089	2 372	2 631	2 738	2 926	3 044	
MBT600V000	Profim BIT 560V • cantilever • seat upholstered pad • plastic backrest • frame: black		2 537	2 785	3 092	3 221	3 375	3 587	

26% rabatt ska dras av på angivna priser

Item no	Base model +	Price Group (PG)	0	①	②	③	④	⑤	Price
MBT700H000	Profim BIT 570H • 4-legged • seat and backrest • upholstered pads • frame: black		2 360	2 726	3 292	3 422	3 882	3 823	
MBT700V000	Profim BIT 570V • cantilever • seat and backrest • upholstered pads • frame: black		2 773	3 186	3 729	3 870	4 331	4 319	
MBT750H000	Profim BIT 575H • 4-legged • seat upholstered pad • mesh backrest • frame: black		2 454	2 726	2 997	3 127	3 316	3 469	
MBT750V000	Profim BIT 575V • cantilever • seat upholstered pad • mesh backrest • frame: black		2 903	3 174	3 446	3 587	3 729	4 000	
MBT800H000	Profim BIT 580H • 4-legged • seat and backrest fully upholstered • frame: black		2 360	3 269	4 496	4 673	5 286	5 204	
MBT800V000	Profim BIT 580V • cantilever • seat and backrest fully upholstered • frame: black		2 773	3 717	4 944	5 133	5 735	5 735	
Accessories/Options/Surcharges:									
7ARMR001	Armrests - plastic, always black (set)								354
7SEQU001	Quilting - pad or front side of the seat (Q1) (Only for: MBT600H000, 560V, 570H, 570V, 575H, 575V)								460
7BAQU001	Quilting - pad or front of the backrest (Q2) (Only for: 570H, 570V)								378

0 price group: Evo

1 price group: Cura, Tonal, Xtreme

2 price group: Select

26% rabatt ska dras av på angivna priser

3 price group: Capture, Oceanic, Step, Synergy

4 price group: Steelcut 3, Steelcut Trio 3

Glides:

- standard - teflon glides (universal),
- option - felt glides (for hard floors).

When ordering please clearly indicate the chosen option.

Plastic of backrest and seat - always black.

Backrest mesh - always black.

Types of mesh: Runner.

Quilting - extra charge to all price groups, lead time 30-40 working days.









26% rabatt ska dras av på angivna priser





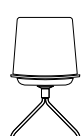

Profim COM

Paul Brooks



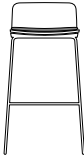

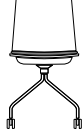

- Five types of bases allow any configuration
- The collection is completed with a barstool on a metal wire frame
- The square shape of the shell has four finishing options: plywood, with upholstered seat pad, with seat and backrest pad or fully upholstered
- The shell can come in different finishes: lacquered plywood, lined with natural veneer or HPL laminate which is scratch resistant

Item no	Base model +	Price Group (PG)	Price Group						Price
			0	①	②	③	④	⑤	
MCM120H000	Profim COM K12H • 4-legged • frame: black • plywood shell								1 399
MCM120V000	Profim COM K12V • cantilever • wire frame • frame: black • stackable • plywood shell								1 509
MCM120CV00	Profim COM K12CV • barstool • frame: black • plywood shell								2 108
MCM120HF00	Profim COM K12HF • "spider" frame • frame: black • plywood shell								2 571
MCM120HS00	Profim COM K12HS • "spider" frame • frame: black • swivel • plywood shell								2 861
MCM120HC00	Profim COM K12HC • "spider" frame • frame: black • on castors • plywood shell								2 907

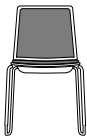



26% rabatt ska dras av på angivna priser

Item no	Base model +	Price Group (PG)	Price Group						Price
			0	①	②	③	④	⑤	
MCM220H000	Profim COM K22H <ul style="list-style-type: none"> • 4-legged • frame: black • plywood shell • seat upholstered pad 		1763	1836	2019	2112	2203	2571	2754
MCM220V000	Profim COM K22V <ul style="list-style-type: none"> • cantilever • wire fame • frame: black • stackable • plywood shell • seat upholstered pad 		1867	1945	2141	2237	2333	2723	2917
MCM220CV00	Profim COM K22CV <ul style="list-style-type: none"> • barstool • frame: black • plywood shell • seat upholstered pad 		2443	2545	2799	2926	3053	3563	3818
MCM220HF00	Profim COM K22HF <ul style="list-style-type: none"> • "spider" frame • frame: black • plywood shell • seat upholstered pad 		2864	2983	3282	3431	3580	4177	4475
MCM220HS00	Profim COM K22HS <ul style="list-style-type: none"> • "spider" frame • frame: black • swivel • seat upholstered pad 		3143	3274	3573	3722	3870	4468	4766
MCM220HC00	Profim COM K22HC <ul style="list-style-type: none"> • "spider" frame • frame: black • on castors • seat upholstered pad 		3187	3320	3619	3767	3917	4513	4811
MCM320H000	Profim COM K32H <ul style="list-style-type: none"> • 4-legged • frame: black • plywood shell • seat and backrest upholstered pads 		2216	2308	2541	2653	2771	3233	3462

26% rabatt ska dras av på angivna priser

Item no	Base model +	Price Group (PG)	Price Group						Price
			0	①	②	③	④	⑤	
MCM320V000	Profim COM K32V <ul style="list-style-type: none"> • cantilever • wire frame • frame: black • stackable • plywood shell • seat and backrest upholstered pads 		2 321	2 418	2 658	2 780	2 900	3 384	3 625
MCM320HF00	Profim COM K32HF <ul style="list-style-type: none"> • "spider" frame • frame: black • plywood shell • seat and backrest upholstered pads 		3 275	3 411	3 752	3 923	4 094	4 777	5 119
MCM320HS00	Profim COM K32HS <ul style="list-style-type: none"> • "spider" frame • frame: black • swivel • seat and backrest upholstered pads 		3 555	3 703	4 044	4 214	4 384	5 067	5 409
MCM320HC00	Profim COM K32HC <ul style="list-style-type: none"> • "spider" frame • frame: black • on castors • seat and backrest upholstered pads 		3 598	3 748	4 089	4 260	4 432	5 113	5 455
MCM420H000	Profim COM K42H <ul style="list-style-type: none"> • 4-legged • frame: black • fully upholstered 		1 988	2 071	2 279	2 384	2 488	2 900	3 108
MCM420V000	Profim COM K42V <ul style="list-style-type: none"> • cantilever • wire frame • frame: black • stackable • fully upholstered 		2 093	2 180	2 400	2 508	2 617	3 053	3 272
MCM420CV00	Profim COM K42CV <ul style="list-style-type: none"> • barstool • frame: black • fully upholstered 		2 600	2 708	2 979	3 114	3 250	3 792	4 062

26% rabatt ska dras av på angivna priser

Item no	Base model +	Price Group (PG)	Price Group						Price
			0	①	②	③	④	⑤	
MCM420HF00	Profim COM K42HF • "spider" frame • frame: black • fully upholstered		3 069	3 197	3 518	3 677	3 837	4 477	4 797
MCM420HS00	Profim COM K42HS • "spider" frame • frame: black • swivel • fully upholstered		3 348	3 488	3 809	3 968	4 128	4 768	5 088
MCM420HC00	Profim COM K42HC • "spider" frame • frame: black • on castors • fully upholstered		3 393	3 534	3 854	4 013	4 174	4 813	5 134
MCM000CTH0	Profim COM CTH • Trolley for transportation								2 054
Accessories/Options/Surcharges:									
7TFRA018	Frame: V1 - cantilever with metal frame (Only for: K12V, K22V, K32V, K42V)								413
7TFRA019	Frame: V2 - reversed cantilever (Only for: K12V, K22V, K32V, K42V)								94
7COPR002	Frames colours: MetallicPro, White RAL 9016, Deep Green RAL 6004, Navy Blue RAL 5003, Burgundy RAL 3005, Salvia/Green RAL 6021, Blue RAL 5014, Terracota RAL 3012 (Only for: K12CV, K12H, K12HC, K12HF, K12HS, K12V, K22CV, K22H, K22HC, K22HF, K22HS, K22V, K32H, K32HC, K32HF, K32HS, K32V, K42CV, K42H, K42HC, K42HF, K42HS, K42V)								35
7COPR003	Frames colours: Lightgrey NCS S 2500-N; Grey NCS S 6500-N, Metalsilver, Steelgray (Only for: K12CV, K12H, K12HC, K12HF, K12HS, K12V, K22CV, K22H, K22HC, K22HF, K22HS, K22V, K32H, K32HC, K32HF, K32HS, K32V, K42CV, K42H, K42HC, K42HF, K42HS, K42V)								212
7COPR006	Frame colour: Gold (Only for: K12HC, K12HF, K12HS, K22HC, K22HF, K22HS, K32HC, K32HF, K32HS, K42HC, K42HF, K42HS)								507
7TARM009	Armrests PP (Only for: K12H, K12V, K22H, K22V, K32H, K32V, K42H, K42V)								509
7TARM003	Armrests - plywood pad (Only for: K12H, K12V, K22H, K22V, K32H, K32V, K42H, K42V)								224
	HPL LW01 (white), LW02 (black), LW03 (light gray)LW04 (grey), LW06 (dark blue), LW07 (light burgundy)(grey) (Only for: K12CV, K12H, K12HC, K12HF, K12HS, K12V, K22CV, K22H, K22HC, K22HF, K22HS, K22V, K32H, K32HC, K32HF, K32HS, K32V)								555
	Natural veneers Ash (NA), Beech (NB), Oak (NO), Walnut (NW) (Only for: K12CV, K12H, K12HC, K12HF, K12HS, K12V, K22CV, K22H, K22HC, K22HF, K22HS, K22V, K32H, K32HC, K32HF, K32HS, K32V)								366
	Natural colored veneers (ash): White (CNA01), Black (CNA02), Dark green (CNA05), Navy blue (CNA06), Burgundy (CNA07) (Only for: K12CV, K12H, K12HC, K12HF, K12HS, K12V, K22CV, K22H, K22HC, K22HF, K22HS, K22V, K32H, K32HC, K32HF, K32HS, K32V)								366

26% rabatt ska dras av på angivna priser

Accessories/Options/Surcharges:

7SEQU001	Quilting - pad or front side of the seat (Q1) (Only for: K22CV, K22H, K22HC, K22HF, K22HS, K22V, K32H, K32HC, K32HF, K32HS, K32V)	366
7BAQU001	Quilting - pad or front of the backrest (Q2) (Only for: K32H, K32HC, K32HF, K32HS, K32V)	366
7SHQU004	Quilting - front side of the shell (Q3) (Only for: K42CV, K42H, K42HC, K42HF, K42HS, K42V)	814
7JIRO001	Possibility of joining in rows (Only for: K12H, K12V, K22H, K22V, K32H, K32V, K42H, K42V)	307
7TATO002	Table top 2PB - extra charge: version with armrests (Only for: K12H, K22H, K32H, K42H)	779
7HAND002	Shell with cut-out (C) in upper part of the backrest, enabling moving the chair (Only for: K12H, K12HC, K12HF, K12HS, K12V, K22H, K22HC, K22HF, K22HS, K22V, K32H, K32HC, K32HF, K32HS, K32V)	35

0 price group: Evo

1 price group: Cura, Tonal, Xtreme

2 price group: Select

3 price group: Capture, Oceanic, Step, Synergy

4 price group: Steelcut 3, Steelcut Trio 3

6 price group: Paloma

Colours of plywood - standard colours of lacquer: H6, H12, H5

Natural veneers -Ash (NA), Beech (NB), Oak (NO), Wallnut (NW)

Coloured natural veneers - White Ash CNA01, Black Ash CNA02, Deep Green Ash CNA05 (RAL 6004), Navy Blue Ash CNA06 RAL 5003, Burgundy Ash CNA07 RAL 3005

HPL - White LW01 (RAL 9016), Light Grey LW03 (NCS S 2500-N), Grey LW04 (RAL 7037), Black LW02 (RAL 9011), Navy Blue LW06 (RAL 5003), Light Burgundy LW07 (RAL 3004)

Glides:

- standard - teflon glides (universal),

- option - felt glides (for hard floors).

When ordering please clearly indicate the chosen option.

Armrest pad: Version V1 - plastic pad, always black.

Version Com K12 / K22 / K32 colour and type of plywood pad is always the same as shell.

Versions Com K4 (fully upholstered) armrest plywood pad finishing:

- Colours of plywood - standard colours of lacquer: H6, H12, H5

- Natural veneers -Ash (NA), Beech (NB), Oak (NO), Wallnut (NW)

- Coloured natural veneers - White Ash CNA01, Black Ash CNA02, Deep Green Ash CNA05 (RAL 6004), Navy Blue Ash CNA06 RAL 5003, Burgundy Ash CNA07 RAL 3005

- HPL - White LW01 (RAL 9016), Light Grey LW03 (NCS S 2500-N), Grey LW04 (RAL 7037), Black LW02 (RAL 9011), Navy Blue LW06 (RAL 5003), Light Burgundy LW07 (RAL 3004)

Please clearly indicate the chosen option.

Armrests:

- 2P - metal, polypropylene pad (set) - does not apply to versions V and V2,

- 2P - metal, plywood pad (set) - does not apply to versions V, V1 and V2.

Quilting - extra charge to all price groups, lead time 30-40 working days.



Frame version: V2

26% rabatt ska dras av på angivna priser



Frame version: V1



26% rabatt ska dras av på angivna priser

Com

Paul Brooks

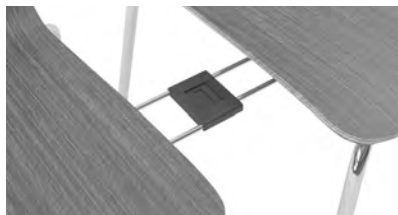

Joining in rows (H/V)

The linking part is an integral part of the chair, therefore it cannot be purchased and assembled at a later stage. The linking part is suitable for versions: H / H 2P / H 2PB / V.

Linking part is made of stainless steel and black plastic.

The total width of two connected chairs is:

- version H - 1160 mm,
- version H 2P/ H2PB - 1240-1310 mm,
- version V - 1170 mm.



Joining in rows (V1/V2)

The linking part is suitable for versions: V1 / V1 2P / V2. Always in black.

Total width of two connected chairs:

- version V1 - 985-1075 mm,
- version V1 2P - 1150-1220 mm,
- version V2 - 1165-1245 mm.



Trolley for transportation (CTH)

Trolley with a handle.

Available colours: black, metallic.

Always with soft castors.

Dimension: 1000 x 1010 x 630 mm



"Anti-panic" system (APA)*

"Anti-panic" connectors for chairs without armrests (refers only to the H versions).

Always in black.

Total width of two connected chairs: 1030 mm.



"Anti-panic" system (APB)*

"Anti-panic" connectors for chairs with armrests/ armrests with table top (refers only to the H versions).

Always in black.

Total width of two connected chairs: 1220-1290 mm.



"Anti-panic" system (APD)*

"Anti-panic" system for connecting rows (refers only to the H versions).

The price is for 1 connector.

Always in black.



Shell with cut-out (C)

Shell with cut-out in upper part of the backrest, enabling moving the chair. Do not concern versions with shell fully upholstered.



Table top (2PB)

The table top is an integral part of 2PB models therefore it cannot be purchased separately.







It is assembled on the right side of the chair and is equipped with anti-panic system which prevents blocking the table top in case of sudden movement. It's always black composite.

Maximum table load: 15kg.

Profim Noor 4-leg

StokkeAustad, Form Us With Love, Susanne Grønlund Design and Flokk design team

- Armrests available in matching colours to frame
- Stackable up to 10 chairs, 5 chairs with armrests (upholstered and unupholstered models)
- Table suspension for Profim Noor 6050/55 to Profim Eminent frame table available (See Eminent table)
- Red Dot Design award 2013
- Norwegian Design Council – Award for Design Excellence

Item no	Base model +	Price Group (PG)	Price Group						Price	
			0	①	②	③	④	⑤		⑥
6050	Profim Noor 6050 • Polypropylene chair									1759
6055	Profim Noor 6055 • 3D veneer chair • Oak									6019
6050s	Profim Noor 6050S • Polypropylene chair • Seat upholstery		1968	2030	2072	2176	2237	2528	2860	
6050sb	Profim Noor 6050SB • Polypropylene chair • Seat + back upholstery		2270	2342	2389	2509	2580	2915	3298	
6050f	Profim Noor 6050F • Polypropylene chair • Fully upholstered in selected fabrics. See below Accessories/options for complete list		2684	2770	2825	2966	3051	3448		
6055s	Profim Noor 6055S • 3D veneer chair • Oak • Seat upholstery		6014	6205	6330	6648	6838	7722	8739	

26% rabatt ska dras av på angivna priser

Item no	Base model +	Price Group (PG)	Price Group						Price
			0	①	②	③	④	⑤	
6055sb	Profim Noor 6055SB • 3D veneer chair • Oak • Seat + back upholstery		6 317	6 515	6 649	6 981	7 149	8 112	9 176

Accessories/Options/Surcharges:

	Additional price* for dark stained oak 3D veneer shell (Only for: 6055, 6055s, 6055sb)	357
4107	Noor armrests - pair	818
99000005	Row connection device	88
31049-02	Felt glides, grey (per pcs)	15
31049-01	Felt glides, black (per pcs)	15
149285	Chair trolley	3662

0 price group: Evo,

1 price group: Cura, Tonal, Xtreme

2 price group: Select

3 price group: Capture, Oceanic, Step, Synergy

4 price group: Steelcut 3, Steelcut Trio 3

6-8 mm polypropylene (PP) and 6.7 mm 3D veneer shells (oak or dark stained oak*)

16x2 mm 4 leg tubular steel base

Weight: 5.7 kg model 6050, 4.7 kg model 6055

Seat height 439 mm, Back height 357 mm, Chair width 543 mm, Chair width w/armrests 550 mm, Chair height 835 mm, Chair depth 490 mm



S=Standard Collection - normal production time 10-15 working days. Applicable when all component options (fabric, shell, frame/legs) are standard (S).

E=Extended Collection - normal production time 20-30 working days. Applicable when any or all component options selected are extended (E).

For larger orders, please contact Customer Service for delivery details.









26% rabatt ska dras av på angivna priser

Profim Noor Sledgebase

StokkeAustad, Form Us With Love, Susanne Grønlund Design and Flokk design team

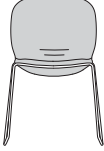
- Armrests available in matching colours to frame
- Stackable up to 10 chairs, 5 chairs with armrests (upholstered and unupholstered models)
- Table suspension for Profim Noor 6060/65 to Profim Eminent frame table available.
- Red Dot Design - 'Best of the best' award winner 2013
- Norwegian Design Council - Award for Design Excellence

Item no	Base model +	Price Group (PG)	Price Group						Price	
			0	①	②	③	④	⑤		⑥
6060	Profim Noor 6060 • Polypropylene chair									1983
6065	Profim Noor 6065 • 3D veneer chair • Oak									6240
6060s	Profim Noor 6060S • Polypropylene chair • Seat upholstery		2 177	2 248	2 292	2 407	2 476	2 796	3 166	
6060sb	Profim Noor 6060SB • Polypropylene chair • Seat + back upholstery		2 480	2 558	2 611	2 741	2 820	3 185	3 602	
6060f	Profim Noor 6060F • Polypropylene chair • Fully upholstered in selected fabrics. See below Accessories/options for complete list		2 896	2 987	3 048	3 197	3 291	3 717		
6065s	Profim Noor 6065S • 3D veneer chair • Oak • Seat upholstery		6 226	6 421	6 554	6 880	7 078	7 995	9 044	

26% rabatt ska dras av på angivna priser

Item no	Base model +	Price Group (PG)	Price Group						Price
			0	①	②	③	④	⑤	
6065sb	Profim Noor 6065SB • 3D veneer chair • Oak • Seat + back upholstery		6 527	6 732	6 870	7 213	7 418	8 382	9 482

Accessories/Options/Surcharges:

	Additional price* for dark stained oak 3D veneer shell (Only for: 6065, 6065s, 6065sb)	357
4107	Noor armrests - pair	818
99000005	Row connection device	88
PD303	Felt glides - 4 units. (Spare part art.no. 125183 per unit)	66
149285	Chair trolley	3662

0 price group: Evo

1 price group: Cura, Tonal, Xtreme

2 price group: Select

3 price group: Capture, Oceanic, Step, Synergy

4 price group: Steelcut 3, Steelcut Trio 3

6-8 mm polypropylene (PP) and 6.7 mm 3D veneer shells (oak or dark stained oak*)

12 mm steel sledgebase

Weight: 6.5 kg model 6060, 6.2 kg model 6065

Seat height 439 mm, Back height 357 mm, Chair width 557 mm, Chair height 835 mm, Chair depth 525 mm



Color selection chart showing various options (E) and standard options (S):

- Poppy (E), Vanilla (S), Straw (E), Rose (E), Coral (E), Sky (E)
- Sea Green (S), Teal Blue (S), Forest (E), Misty Grey (S), Clay (S), Graphite (S)
- Lignon (E), Snow (S), Canola (E), Rose (E), Aqua (E), Sea Green (S)
- Teal Blue (S), Forest (E), Misty Grey (E), Black (S), Metalsilver (S), Steelgrey (S)
- Oak (S), Dark stained Oak* (S)

S=Standard Collection – normal production time 10-15 working days. Applicable when all component options (fabric, shell, frame/legs) are standard (S).

E=Extended Collection – normal production time 20-30 working days. Applicable when any or all component options selected are extended (E).

For larger orders, please contact Customer Service for delivery details.



26% rabatt ska dras av på angivna priser

Profim Noor Footbase

StokkeAustad, Form Us With Love, Susanne Grønlund Design and Flokk design team

- Standard gaslift B black
- Seat mechanism and footbase (Ø665 mm) in black painted aluminium as standard.
- Polished aluminium seat mechanism and footbase available as option. Seat mechanism, gaslift and footbase in white lacquered aluminium available as option
- Armrest available in black, white or metal silver
- Table suspension for Profim Noor 6070/75 to Profim Eminent frame table available.
- Red Dot Design Award 2013
- Norwegian Design Council – Award for Design Excellence

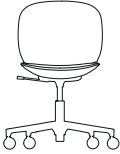
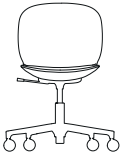
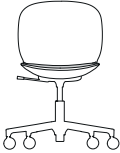
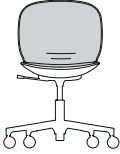
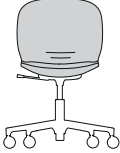
Item no	Base model +	Price Group (PG)	Price Group						Price	
			0	①	②	③	④	⑤		⑥
6070	Profim Noor 6070 • Polypropylene chair									2870
6075	Profim Noor 6075 • 3D veneer chair • Oak									7129
6070s	Profim Noor 6070S • Polypropylene chair • Seat upholstery		3 023	3 120	3 182	3 196	3 437	3 882	4 391	
6070sb	Profim Noor 6070SB • Polypropylene chair • Seat + back upholstery		3 325	3 429	3 500	3 674	3 778	4 268	4 828	
6070f	Profim Noor 6070F • Polypropylene chair • Fully upholstered in selected fabrics. See below Accessories/options for complete list		3 738	3 855	3 935	4 130	4 251	4 800		

26% rabatt ska dras av på angivna priser

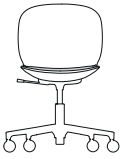
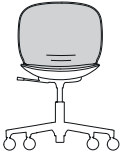
Item no	Base model +	Price Group (PG)	Price Group						Price
			0	①	②	③	④	⑤	
6075s	Profim Noor 6075S • 3D veneer chair • Oak • Seat upholstery		7 068	7 292	7 440	7 813	8 036	9 075	10 268
6075sb	Profim Noor 6075SB • 3D veneer chair • Oak • Seat + back upholstery		7 370	7 604	7 758	8 144	8 377	9 464	10 708

Accessories/Options/Surcharges:

	Additional price* for dark stained oak 3D veneer shell (Only for: 6075, 6075s, 6075sb)	357
4107	Noor armrests - pair	818
	Additional price for seat mechanism and footbase in polished aluminium	562
	Additional price for seat mechanism, gaslift and footbase in white aluminium	469
125190	Castors Ø65 mm for soft floors, black	0
125182	Glides, 58 mm	0

0 price group: Evo,

1 price group: Cura, Tonal, Xtreme

2 price group: Select

3 price group: Capture, Oceanic, Step, Synergy

4 price group: Steelcut 3, Steelcut Trio 3

6-8 mm polypropylene (PP) and 6.7 mm 3D veneer shells (oak or dark stained oak*)

Weight: 8.0 kg model 6070, 7.6 kg model 6075

Seat height 355-490 mm, back height 357 mm, chair width and depth 665 mm, chair height 727-857 mm



S=Standard Collection - normal production time 10-15 working days. Applicable when all component options (fabric, shell, frame/legs) are standard (S).

E=Extended Collection - normal production time 20-30 working days. Applicable when any or all component options selected are extended (E).

For larger orders, please contact Customer Service for delivery details.









26% rabatt ska dras av på angivna priser

Profim Noor Wooden legs

StokkeAustad, Form Us With Love, Susanne Grønlund Design and Flokk design team

- Seat frame in black painted aluminium as standard.
- Wooden legs: natural stained ash as standard.
- Not stackable
- Red Dot Design Award 2013
- Norwegian Design Council – Award for Design Excellence

Item no	Base model +	Price Group (PG)	Price Group						Price	
			0	①	②	③	④	⑤		⑥
6080	Profim Noor 6080 • Polypropylene chair									4 441
6085	Profim Noor 6085 • 3D veneer chair • Oak									8 702
6080s	Profim Noor 6080S • Polypropylene chair • Seat upholstery		4 516	4 661	4 754	4 993	5 136	5 799	6 560	
6080sb	Profim Noor 6080SB • Polypropylene chair • Seat + back upholstery		4 820	4 970	5 074	5 324	5 479	6 188	6 999	
6080f	Profim Noor 6080F • Polypropylene chair • Fully upholstered in selected fabrics. See below Accessories/options for complete list		5 235	5 398	5 510	5 785	5 952	6 723		
6085s	Profim Noor 6085S • 3D veneer chair • Oak • Seat upholstery		8 564	8 833	9 015	9 465	9 736	10 999	12 439	

26% rabatt ska dras av på angivna priser

Item no	Base model +	Price Group (PG)	Price Group						Price
			0	①	②	③	④	⑤	
6085sb	Profim Noor 6085SB • 3D veneer chair • Oak • Seat + back upholstery		8 864	9 145	9 330	9 799	10 077	11 384	12 877

Accessories/Options/Surcharges:

Additional price* for dark stained oak 3D veneer shell (Only for: 6085, 6085s, 6085sb)	357
Additional price for seat frame in polished aluminium	155
31051-01 Felt glides, black (per pcs)	16

0 price group: Evo,

1 price group: Cura, Tonal, Xtreme

2 price group: Select

3 price group: Capture, Oceanic, Step, Synergy

4 price group: Steelcut 3, Steelcut Trio 3

6-8 mm polypropylene (PP) and 6.7 mm 3D veneer shells (oak or dark stained oak*)

Weight: 5.4 kg model 6080, 4.6 kg model 6085

Seat height 439 mm, Back height 357 mm, Chair width 490 mm, Chair height 832 mm, Chair depth 480 mm



S=Standard Collection - normal production time 10-15 working days. Applicable when all component options (fabric, shell, frame/legs) are standard (S).

E=Extended Collection - normal production time 20-30 working days. Applicable when any or all component options selected are extended (E).

For larger orders, please contact Customer Service for delivery details.









26% rabatt ska dras av på angivna priser

Profim Noor Up

StokkeAustad, based on the design of the RBM Noor of StokkeAustad, Form Us With Love, Susanne Grønlund Design and Flokk design team

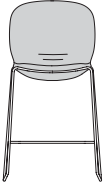
- Suitable for tables around 90 cm high
- Armrests available in matching colours to frame
- Stackable up to 5 chairs

Item no	Base model +	Price Group (PG)	Price Group						Price	
			0	①	②	③	④	⑤		⑥
6090	Profim Noor Up 6090 • Polypropylene chair									2690
6095	Profim Noor Up 6095 • 3D veneer chair • Oak									6950
6090s	Profim Noor Up 6090S • Polypropylene chair • Seat upholstery		2854	2945	3004	3152	3243	3663	4145	
6090sb	Profim Noor Up 6090SB • Polypropylene chair • Seat + back upholstery		3154	3253	3320	3486	3587	4050	4581	
6090f	Profim Noor Up 6090F • Polypropylene chair • Fully upholstered in selected fabrics. See below Accessories/options for complete list		3568	3682	3756	3945	4058	4582		
6095s	Profim Noor Up 6095S • 3D veneer chair • Oak • Seat upholstery		6901	7120	7264	7627	7844	8861	10022	

26% rabatt ska dras av på angivna priser

Item no	Base model +	Price Group (PG)	Price Group						Price
			0	①	②	③	④	⑤	
6095sb	Profim Noor Up 6095SB • 3D veneer chair • Oak • Seat + back upholstery		7 201	7 430	7 580	7 958	8 186	9 247	10 459

Accessories/Options/Surcharges:

	Additional price* for dark stained oak 3D veneer shell (Only for: 6095, 6095s, 6095sb)	368
4107	Noor armrests - pair	818
PD303	Felt glides - 4 units. (Spare part art.no. RS092031 per unit).	66

0 price group: Evo,

1 price group: Cura, Tonal, Xtreme

2 price group: Select

3 price group: Capture, Oceanic, Step, Synergy

4 price group: Steelcut 3, Steelcut Trio 3

6-8 mm polypropylene (PP) and 6.7 mm 3D veneer shells (oak or dark stained oak*)

Weight: 7.7 kg model 6090, 7.2 kg model 6095

12 mm medium-high steel sledgebase

Seat height 630 mm, Back height 357 mm, Chair width 565 mm, Chair height 1025 mm, Chair depth 548 mm



S=Standard Collection - normal production time 10-15 working days. Applicable when all component options (fabric, shell, frame/legs) are standard (S).

E=Extended Collection - normal production time 20-30 working days. Applicable when any or all component options selected are extended (E).

For larger orders, please contact Customer Service for delivery details.





26% rabatt ska dras av på angivna priser

Profim NORMO

Studio Ganszyniec

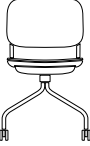
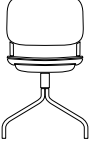
- Chair designed for work and meetings
 - Solid metal construction guarantees stability regardless of intensity of use
 - Our first circular product
 - Manufactured without the use of glue or staples for easy disassembly
 - The seat structure is created from 100% recycled plastic (PP)
 - Normo can be separated/disassembled and recycled up to 94%

Item no	Base model +	Price Group (PG)	Price Group						Price
			0	①	②	③	④	⑤	
MKN500H000	Profim NORMO 500H • 4 legged • seat and backrest upholstered		2 466	2 738	3 139	3 269	3 646	3 646	4 201
MKN500HC00	Profim NORMO 500HC • spider' frame on castors • seat and backrest upholstered		3 410	3 682	4 083	4 236	4 590	4 732	5 463
MKN500HS00	Profim NORMO 500HS • spider' frame on glides • swivel • seat and backrest upholstered		3 670	3 929	4 331	4 508	4 826	5 039	5 794
MKN500V000	Profim NORMO 500V • cantilever • seat and backrest upholstered		2 549	2 820	3 221	3 351	3 717	3 729	4 319

Accessories/Options/Surcharges:

7ARMR020	SP - metal armrests, short	366
7ARMR021	LP - metal armrests, long	425

0 price group: Evo

1 price group: Cura, Tonal, Xtreme

2 price group: Select

3 price group: Capture, Oceanic, Step, Synergy

4 price group: Steelcut 3, Steelcut Trio 3

Frames colours:

- Black RAL 9005
- MetallicPro
- White RAL 9016

26% rabatt ska dras av på angivna priser

- Lightgrey NCS S 2500-N
- Grey NCS S 6500-N
- Deep green RAL 6004
- Navy blue RAL 5003
- Burgundy RAL 3005
- Salvia/Green RAL 6021
- Blue RAL 5014
- Terracota RAL 3012

Glides:

- teflon glides (universal).
- felt glides (for hard floors).

Castors in HC model:

- universal.

When ordering please clearly indicate the chosen option.



Armrest SP



Armrest LP





26% rabatt ska dras av på angivna priser

Profim ZOO

Paul Brooks

- Variety of configurations
- Available in different versions: on four legs, legs with castors, with plastic or upholstered seat, plastic or upholstered backrest, with or without armrests
- Available in three plastic colours (black, grey and light grey) and five frame colours

Item no	Base model +	Price Group (PG)	0	①	②	③	④	⑤	Price
MZO522H000	Profim ZOO 522H • 4-legged • frame: black • plastic seat and backrest								2077
MZO502H000	Profim ZOO 502H • 4-legged • frame: black • upholstered seat • plastic backrest		2 336	2 549	2 714	2 820	3 328	3 139	
MZO500H000	Profim ZOO 500H • 4-legged • frame: black • upholstered seat and backrest		3 363	3 788	4 236	4 413	5 227	4 921	

Accessories/Options/Surcharges:

7TFRA005	Frame HC - 4-legged version with castors	590
7CFRA051	Frame: MetallicPro	35
7ARMR001	Armrests	448
7TATO002	Table top	814
7JIRO001	Possibility of joining in rows	319

0 price group: Evo

1 price group: Cura, Tonal, Xtreme

2 price group: Select

3 price group: Capture, Oceanic, Step, Synergy

4 price group: Steelcut 3, Steelcut Trio 3

Glides:

- standard - teflon glides (universal),
- option - felt glides (for hard floors).

Castors in HC models:

- universal castors

When ordering please clearly indicate the chosen option.

Plastic colours for seats, backrests and armrests:

black (RAL 9005), grey (NCS S 6500-N), lightgrey (NCS S 2500-N).

It is possible to freely join the colours of seat, backrest and armrests.

26% rabatt ska dras av på angivna priser

Although in one RAL/NCS, the colour of individual elements of the chair such as seat, backrest, armrests and frame, can vary due to different types of materials used.

Seat cover:

- black frame - cover always black (RAL 9005),
- MetallicPro, RAL/NCS - cover always grey (NCS S 6500-N), except of chairs with black plastic seat - in that case cover is always black (RAL 9005).

In model Zoo 500 without armrests the plastic elements

connecting the frame with backrest are:

- black frame - always black (RAL 9005),
- MetallicPro frame - always grey (NCS S 6500-N),
- grey / lightgrey frame - always in frame colour.



Frame version: HC



26% rabatt ska dras av på angivna priser

Zoo

Paul Brooks



Table top (2PB)

The table top is an integral part of 2PB models therefore it cannot be purchased separately. It is assembled on the right side of the chair and is equipped with anti-panic system which prevents blocking the table top in case of sudden movement. It's always black composite. Maximum table load: 15 kg.

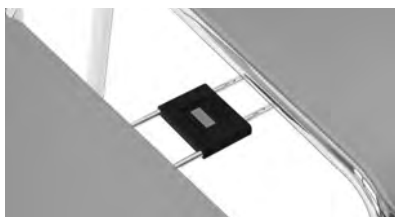

Joining in rows - 4-legged version

The linking part is an integral part of the chair, therefore it cannot be purchased and assembled at a later stage. The linking part is suitable for versions on 4 legs (H/H 2P/H 2PB). Linking part is made of stainless steel and black plastic. The total width of two connected chairs is:
- no armrests - 1070 mm,
- with armrests - 1260 mm.



„Anti-panic” system (APA)*

"Anti-panic" connectors for chairs without armrests. Available colours: black, metallic. Total width of two connected chairs: 1120 mm. The anti-panic system meets EN 14703 norm.



„Anti-panic” system (APB)*

"Anti-panic" connectors for chairs with armrests. Always in black. Total width of two connected chairs: 1170 mm. The anti-panic system meets EN 14703 norm.



„Anti-panic” system (APC)*

"Anti-panic" connectors for chairs with armrests and a table top. Always in black. Total width of two connected chairs: 1350 mm. The anti-panic system meets EN 14703 norm.



„Anti-panic” system (APD)*

"Anti-panic" system for connecting rows. The price is for 1 connector. Always in black. The anti-panic system meets EN 14703 norm.



Trolley for transportation (CTH)

Trolley with a handle. Available colours: black, metallic. Always with soft castors. Dimensions: 1000 x 1000 x 600 mm

Sofas

Armchairs





Modular systems

26% rabatt ska dras av på angivna priser

Profim CHIC

Christophe Pillet

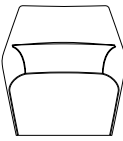
- The seat is equipped with the return memory (it returns to the starting position by itself)
- Restaurant and bar chairs with a range of bases and armchairs with a swivel base or with glides
- Möbelfakta certificate - a guarantee of durability, safety, environmental care and social responsibility during the production process

Item no	Base model +	Price Group (PG)	Price Group						Price
			0	①	②	③	④	⑤	
MCC210H000	Profim CHIC 21H • chair • metal legs • frame: MetallicPro; Black RAL 9005; White RAL 9016; Deep Green RAL 6004; Navy Blue RAL 5003; Burgundy RAL 3005; Salvia/Green RAL 6021, Blue RAL 5014; Terracota RAL 3012 • without armrests		4 118	4 290	4 718	4 934	5 149	6 006	6 434
MCC200H000	Profim CHIC 20H • chair • metal legs • frame: MetallicPro; Black RAL 9005; White RAL 9016; Deep Green RAL 6004; Navy Blue RAL 5003; Burgundy RAL 3005; Salvia/Green RAL 6021, Blue RAL 5014; Terracota RAL 3012 • with armrests		4 501	4 689	5 158	5 393	5 628	6 566	7 035
MCC200F000	Profim CHIC 20F • chair • base: polished aluminium • 4-star base		5 182	5 398	5 938	6 209	6 479	7 558	8 097
MCC100FU00	Profim CHIC 10FU • armchair		6 580	6 854	7 539	7 881	8 223	9 593	10 279
MCC210CH00	Profim CHIC 21CH • bar stool without armrests • metal legs • frame: MetallicPro; Black RAL 9005; White RAL 9016; Deep Green RAL 6004; Navy Blue RAL 5003; Burgundy RAL 3005; Salvia/Green RAL 6021, Blue RAL 5014; Terracota RAL 3012		4 817	5 018	5 519	5 769	6 021	7 023	7 525
MCC200CH00	Profim CHIC 20CH • bar stool • metal legs • frame: MetallicPro; Black RAL 9005; White RAL 9016; Deep Green RAL 6004; Navy Blue RAL 5003; Burgundy RAL 3005; Salvia/Green RAL 6021, Blue RAL 5014; Terracota RAL 3012		5 199	5 416	5 959	6 229	6 499	7 584	8 125

26% rabatt ska dras av på angivna priser

Accessories/Options/Surcharges:

7TFRA011	Frame: HW - wooden legs beech wood - H5, H6, H7, H8, H11, H12 (HW) (Only for: 20H, 21H)	2592
7TGAS003	Gas lift with memory (Only for: 20F)	779
7TFRA022	Gas lift with memory without height adjustment (Only for: 10FU)	1900
7COPR003	Frames colours: Lightgrey NCS S 2500-N; Grey NCS S 6500-N , Metalsilver, Steelgray (Only for: 20CH, 20H, 21CH, 21H)	212
7COPR006	Frame colour: Gold (Only for: 20H, 21H)	413

0 price group: Evo

1 price group: Cura, Tonal, Xtreme

2 price group: Select

3 price group: Capture, Oceanic, Step, Synergy

4 price group: Steelcut 3, Steelcut Trio 3

6 price group: Paloma

Glides:

- standard - teflon glides (universal),

- option - felt glides (for hard floors).

When ordering please clearly indicate the chosen option.



Frame version: HW







26% rabatt ska dras av på angivna priser

Profim CHIC LOUNGE

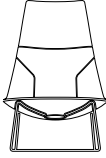
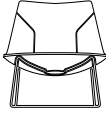
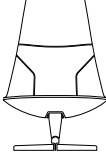
Christophe Pillet

- Characteristic detail in the form of vertical stitching
- Two backrest levels – for different needs and different users
- Possibility to combine leather and fabric in one cover
- Possibility to choose different upholstery colours
- Cushion and footrest increase the comfort of rest
- Attractive price/quality ratio
- Möbelfakta certificate - a guarantee of durability, safety, environmental care and social responsibility during the production process

Item no	Base model +	Price Group (PG)	①	②	③	④	⑤	⑥	Price
MCLA10V300	Profim CHIC LOUNGE A10V3 • armchair • high backrest • wire frame • frame: MetallicPro; Black RAL 9005; White RAL 9016; Deep Green RAL 6004; Navy Blue RAL 5003; Burgundy RAL 3005; Salvia/Green RAL 6021, Blue RAL 5014; Terracota RAL 3012		8 270	9 097	9 511	9 925	11 578	15 576	
MCLA20V300	Profim CHIC LOUNGE A20V3 • armchair • low backrest • wire frame • frame: MetallicPro; Black RAL 9005; White RAL 9016; Deep Green RAL 6004; Navy Blue RAL 5003; Burgundy RAL 3005; Salvia/Green RAL 6021, Blue RAL 5014; Terracota RAL 3012		7 436	8 177	8 551	8 921	10 408	13 546	
MCLA10F000	Profim CHIC LOUNGE A10F • armchair • high backrest • 4-star base • frame: MetallicPro; Black RAL 9005; White RAL 9016; Deep Green RAL 6004; Navy Blue RAL 5003; Burgundy RAL 3005; Salvia/Green RAL 6021, Blue RAL 5014; Terracota RAL 3012		10 670	11 735	12 272	12 804	14 939	18 432	
MCLA20F000	Profim CHIC LOUNGE A20F • armchair • low backrest • 4-star base • frame: MetallicPro; Black RAL 9005; White RAL 9016; Deep Green RAL 6004; Navy Blue RAL 5003; Burgundy RAL 3005; Salvia/Green RAL 6021, Blue RAL 5014; Terracota RAL 3012		9 834	10 817	11 307	11 800	13 767	16 343	
MCLPV30000	Profim CHIC LOUNGE PV3 • footrest • wire frame • frame: MetallicPro; Black RAL 9005; White RAL 9016; Deep Green RAL 6004; Navy Blue RAL 5003; Burgundy RAL 3005; Salvia/Green RAL 6021, Blue RAL 5014; Terracota RAL 3012		4 525	4 978	5 206	5 431	6 336	8 107	
MCLCU00000	Profim CHIC LOUNGE CU • high backrest cushion		763	841	877	916	1 070	1 699	

26% rabatt ska dras av på angivna priser

Accessories/Options/Surcharges:

7COPR003	Frames colours: Lightgrey NCS S 2500-N; Grey NCS S 6500-N , Metalsilver, Steelgray (Only for: A10F, A10V3, A20F, A20V3, PV3)	212
7COPR006	Frame colour: Gold (Only for: A10F, A20F)	720
7COPR006	Frame colour: Gold (Only for: A10V3, A20V3, PV3)	507

1 price group: Cura, Tonal, Xtreme

2 price group: Select

3 price group: Capture, Oceanic, Step, Synergy

4 price group: Steelcut 3, Steelcut Trio 3

6 price group: Paloma

Glides:

- standard - teflon glides (universal),

- option - felt glides (for hard floors).

When ordering please clearly indicate the chosen option.

Option of mixing colours of the same fabric according to below scheme:

A - inner part of shell colour, B - outer part of shell colour.

In case of order of such option, following example should be specified: SC-67097/SC-60132 (where SC-67097 - A, SC-60132 - B).

Option is available at no extra charge.

In models A10V3/A10F it is possible to order extra cushion for the backrest.







26% rabatt ska dras av på angivna priser

Profim ELLIE PRO

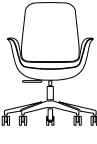
ITO Design

- Quick and easy adjustment with the synchro self mechanism (height and tilt adjustment).
- Mechanism fully integrated into the seat
- Possibility of choosing two-colour upholstery
- Several types and colours of bases (four- and five-star bases and metal wire frame or version with wooden legs)
- Blue Angel certificate - confirms that our chair is environmentally friendly

Item no	Base model +	Price Group (PG)	0	①	②	③	④	⑤	Price
MHB100ST00	Profim ELLIE PRO 10ST <ul style="list-style-type: none"> • swivel armchair • Self mechanism • high backrest • 5-star base • base: black 		7 194	7 494	8 243	8 617	8 993	10 490	
MHB200ST00	Profim ELLIE PRO 20ST swivel armchair Self mechanism low backrest 5-star base base: black		6 914	7 202	7 922	8 282	8 642	9 867	
MHB100HS00	Profim ELLIE PRO 10HST <ul style="list-style-type: none"> • swivel armchair • Self mechanism • high backrest • high 4-star base • base: black / MetallicPro / white / polished aluminum 		7 731	8 053	8 857	9 259	9 662	11 273	
MHB200HS00	Profim ELLIE PRO 20 HST <ul style="list-style-type: none"> • swivel armchair • Self mechanism • low backrest • high 4-star base • base: black / MetallicPro / white / polished aluminum 		7 451	7 761	8 537	8 926	9 312	10 866	
MHB100V000	Profim ELLIE PRO 10V3 <ul style="list-style-type: none"> • swivel armchair • Self mechanism • high backrest • wire frame • frame: black / MetallicPro / white 		8 096	8 433	9 278	9 700	10 120	11 807	
MHB200V000	Profim ELLIE PRO 20V3 <ul style="list-style-type: none"> • swivel armchair • Self mechanism • low backrest • wire frame • frame: black / MetallicPro / white 		7 817	8 143	8 958	9 363	9 772	11 401	

26% rabatt ska dras av på angivna priser

Item no	Base model +	Price Group (PG)	0	①	②	③	④	⑤	Price
MHB100HW00	Profim ELLIE PRO 10HW <ul style="list-style-type: none"> • swivel armchair • Self mechanism • high backrest • wooden legs • frame: beech wood - H5, H6, H12 		10 278	10 706	11 777	12 312	12 847	14 987	

MHB200HW00	Profim ELLIE PRO 20HW <ul style="list-style-type: none"> • swivel armchair • Self mechanism • low backrest • wooden legs • frame: beech wood - H5, H6, H12 		9 999	10 416	11 456	11 978	12 497	14 580	
------------	--	---	-------	--------	--------	--------	--------	--------	--

Accessories/Options/Surcharges:

7BASC008	Light Gray (Only for: 10ST, 20ST)	106
7TARM006	Upholstered armpad - leather pad on the armrests	212
7COPR003	Frames colours: Lightgrey NCS S 2500-N; Grey NCS S 6500-N (Only for: 10V3, 20V3)	212
7CFRA025	Frame : metalsilver (Only for: 10V3, 20V3)	236
7COPR006	Frame colour: Gold (Only for: 10V3, 20V3)	696

0 price group: Evo

1 price group: Cura, Tonal, Xtreme

2 price group: Select

3 price group: Capture, Oceanic, Step, Synergy

4 price group: Steelcut 3, Steelcut Trio 3

Castors / glides:

Standard:

- hard castors - for soft floors.

Option:

- soft castors - for hard floors,

- teflon glides - universal,

- felt glides - for hard floors.

When ordering please clearly indicate the chosen option.

In case of armrests with a leather pad, the threads will always be the same as the upholstery inside the shell.

In models HST, V3, HW Self mechanism is not height adjustable.

Option of mixing colours of the same fabric according to below scheme:

A - inner part of shell colour, B - outer part of shell colour.

In case of order of such option, following example should be specified: SC-67097/SC-60132 (where SC-67097 - A, SC-60132 - B). Option is available at no extra charge.









www.blauer-engel.de/uz117

26% rabatt ska dras av på angivna priser

Profim FAN

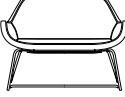
Piotr Kuchciński

- Several types of bases - glides and castors as well as wooden legs which perfectly match the SW40 and Revo tables
- Additional cushion improves comfort of use
- The collection also includes a cantilever sofa
- Two types of thread to choose from (upholstery colour or decorative thread)
- Möbelfakta certificate - a guarantee of durability, safety, environmental care and social responsibility during the production process

Item no	Base model +	Price Group (PG)	Price Group						Price
			0	①	②	③	④	⑤	
MFN100H000	Profim FAN 10H • armchair • 4-legged • frame: black		3 717	3 872	4 452	4 839	5 227	5 807	6 194
MFN100V000	Profim FAN 10V • armchair • cantilever • frame: black		3 961	4 126	4 747	5 157	5 570	6 190	6 601
MFN200V000	Profim FAN 20V • 2-seat sofa • cantilever • frame: black		5 971	6 915	8 225	8 555	10 974	9 546	12 956
MFN100R000	Profim FAN 10R • swivel armchair • round base • Gas lift with memory • base: MetallicPro, White RAL 9016, Deep Green RAL 6004, Navy Blue RAL 5003, Burgundy RAL 3005, Salvia/Green RAL 6021, Blue RAL 5014, Terracota RAL 3012		5 428	6 089	6 691	6 962	8 319	7 823	9 782
MFN100F000	Profim FAN 10F • swivel armchair • 4-star base • base: polished aluminum		5 924	6 537	7 139	7 422	8 767	8 319	10 231
MFN100Z000	Profim FAN 10Z • swivel armchair • Rocker mechanism • base: black		4 378	4 991	5 593	5 817	7 139	6 691	8 567

26% rabatt ska dras av på angivna priser

Item no	Base model +	Price Group (PG)	Price Group						Price
			0	①	②	③	④	⑤	
MFN100E000	Profim FAN 10E swivel armchair Economic mechanism base: black		3 953	4 567	5 180	5 381	6 738	6 278	8 177
MFN1000000	Profim FAN CU • seat cushion for FAN 10 version		540	563	654	928	1 128	1 200	1 272

Accessories/Options/Surcharges:

7TFRA010	Frame: HS - swivel version on glides (Only for: 10H)	363
7TFRA009	Frame: HC - version with castors (Only for: 10H)	434
7TFRA011	Frame: HW - wooden legs - beech wood: H5, H6, H12 (Only for: 10H)	1 613
7COPR002	Frames colours: MetallicPro, White RAL 9016, Deep Green RAL 6004, Navy Blue RAL 5003, Burgundy RAL 3005, Salvia/Green RAL 6021, Blue RAL 5014, Terracota RAL 3012 (Only for: 10H, 10V)	35
7COPR002	Frames colours: MetallicPro, White RAL 9016, Deep Green RAL 6004, Navy Blue RAL 5003, Burgundy RAL 3005, Salvia/Green RAL 6021, Blue RAL 5014, Terracota RAL 3012 (Only for: 20V)	59
7COPR006	Frame colour: Gold (Only for: 10H, 10V)	507
7COPR006	Frame colour: Gold (Only for: 20V)	1 003
7COPR003	Frames colours: Lightgrey NCS S 2500-N; Grey NCS S 6500-N, Metalsilver, Steelgray (Only for: 10H, 10R, 10V, 20V)	212
7BASC027	Base: MetallicPro (Only for: 10E, 10Z)	366
7BASC003	Base: polished aluminum (Only for: 10Z, 10E)	779
7CPLY010	Oak wood - HO6, HO12, HO11 (Only for: 10H)	319
7TGAS003	Gas lift with memory (Only for: 10F)	814

0 price group: Evo

1 price group: Cura, Tonal, Xtreme

2 price group: Select

3 price group: Capture, Oceanic, Step, Synergy

4 price group: Steelcut 3, Steelcut Trio 3

6 price group: Paloma

Castors / glides

Standard:

- universal castors (models 10Z/10E/10HC),
- teflon glides - universal (models 10F/10H/10HS/10HW),
- hard glides - for soft floors (models 10V/20V).

Option:

- teflon glides - universal (10Z/10E),
- felt glides - for hard floors (10H/10HS/10HW/10V/20V/10F),
- felt pads under the base - for hard floors (model 10R).

When ordering please clearly indicate the chosen option.

Model 10HW: wooden legs: beech wood - H5, H6, H12,

Two options of threads:

26% rabatt ska dras av på angivna priser

- upholstery matching threads
 - decorative threads:
 - black upholstery - threads always white,
 - all other colours of upholstery - threads always black.
- Option is available at no extra charge.



Frame version: 10HC







Frame version: 10HW



Profim NU

Paul Brooks

- The inner and outer sections of the shell may have different coloured fabrics
- The shell is mounted on several types of bases
- The cushion will increase the comfort of rest
- Möbelfakta certificate - a guarantee of durability, safety, environmental care and social responsibility during the production process

Item no	Base model +	Price Group (PG)	Price Group						Price
			0	①	②	③	④	⑤	
MNU200H000	Profim NU 20H • armchair • swivel • 4-legged • frame: black		4 817	5 018	5 519	5 769	6 021	7 023	11 517
MNU200V000	Profim NU 20V3 • armchair • wire frame • frame: black		4 713	4 909	5 398	5 643	5 890	6 871	11 281
MNU200R000	Profim NU 20R • swivel armchair • round base • base: MetallicPro, White RAL 9016, Deep Green RAL 6004, Navy Blue RAL 5003, Burgundy RAL 3005, Salvia/Green RAL 6021, Blue RAL 5014, Terracota RAL 3012		6 797	7 410	8 107	8 425	10 561	12 248	14 030
MNU200F000	Profim NU 20F • swivel armchair • 4-star base • base: polished aluminum		6 317	6 580	7 238	7 567	7 895	9 212	14 750

Accessories/Options/Surcharges:

7TFRA009	Frame: HC - version with castors - white / graphite / polished aluminum (Only for: 20H)	606
7TFRA011	Frame: HW - wooden legs - beech wood: H5, H6, H7, H8, H11, H12, H13 (Only for: 20H)	1 108
7COPR002	Frames colours: MetallicPro, White RAL 9016, Deep Green RAL 6004, Navy Blue RAL 5003, Burgundy RAL 3005, Salvia/Green RAL 6021, Blue RAL 5014, Terracota RAL 3012 (Only for: 20H, 20V3)	47
7COPR003	Frames colours: Lightgrey NCS S 2500-N; Grey NCS S 6500-N, Metalsilver, Steelgray (Only for: 20H, 20R, 20V3)	212
7COPR006	Frame colour: Gold (Only for: 20H, 20V3)	507
7SHQU006	Quilting - front side of the seat (Q5)	484
7TGAS003	Gas lift with memory (Only for: 20F, 20R)	814

0 price group: Evo

1 price group: Cura, Tonal, Xtreme

2 price group: Select

26% rabatt ska dras av på angivna priser

3 price group: Capture, Oceanic, Step, Synergy

4 price group: Steelcut 3, Steelcut Trio 3

Glides

Standard:

- teflon glides – universal (models 20HS/20HW/20V3/20F).

Option:

- hard castors - for soft floors (model 20H/20HC),

- soft castors - for hard floors (model 20H/20HC),

- teflon glides – universal (models 20H/20HS, 20HW),

- felt glides - for hard floors

When ordering please clearly indicate the chosen option.

Model 20HW: wooden legs: beech wood - H5, H6, H12.

Option of mixing colours of the same fabric according to below scheme:

A - cushion, B - inner part of the shell, C - outer part of the shell.

In case of order of such option, following example should be specified: SC-67097/SC-60132/SC-60999 (where SC-67097 - A, SC-60132 - B, SC-60999 - C).

Option is available at no extra charge.

Quilting - extra charge to all price groups, lead time 30-40 working days.



Frame version: 20HC



Frame version: 20HW



26% rabatt ska dras av på angivna priser





Profim REVO

Pearson Lloyd

- Represents a radical rethinking of the way office furniture is made.
- Created from recycled and infinitely recyclable REPP, instead of plywood
- Includes sofas, benches, screens, stools and tables in softly contoured, organic shapes
- With 96 configurations can be customised to suit every workspace, whatever its function or size
- The weight of the product is reduced by 40% lowering the carbon footprint during production and transportation by 13% and 40% respectively.
- Manufactured without the use of glue or staples for easy disassembly

Item no	Base model +	Price Group (PG)	Price Group						Price
			0	①	②	③	④	⑤	
MRVP400000	Profim REVO P40 • Pouffe, • Ø 40 cm	 	4 854	5 056	5 567	5 845	6 079	7 112	9 631
MRVP600000	Profim REVO P60 • Pouffe, • Ø 60 cm	 	5 877	6 122	6 878	7 222	7 511	8 787	13 641
MRVSN15000	Profim REVO SN150 • Seat narrow, • length 150 cm	 	11 424	11 900	12 767	13 405	13 941	16 311	22 087
MRVSN21000	Profim REVO SN210 • Seat narrow, • length 210 cm	 	14 624	15 233	16 389	17 208	17 897	20 939	32 509
MRVSW12000	Profim REVO SW120 • Seat wide, • length 120 cm	 	12 096	12 600	13 444	14 117	14 681	17 177	23 258
MRVSW18000	Profim REVO SW180 • Seat wide, • length 180 cm	 	16 107	16 778	17 889	18 783	19 535	22 856	30 948

26% rabatt ska dras av på angivna priser

Item no	Base model +	Price Group (PG)	Price Group						Price
			0	①	②	③	④	⑤	
MRVSW24000	Profim REVO SW240 • Seat wide, • length 240 cm		19 989	20 822	22 200	23 310	24 242	28 364	38 406
MRVB900000	Profim REVO B90 • Backrest, • length 90 cm		4 352	4 533	4 944	5 192	5 399	6 317	8 553
MRVB120000	Profim REVO B120 • Backrest, • length 120 cm		5 205	5 422	5 922	6 218	6 467	7 566	10 245
MRVB180000	Profim REVO B180 • Backrest, • length 180 cm		7 392	7 700	8 433	8 855	9 209	10 775	14 589
MRVW900000	Profim REVO W90 • Screen, • wide 90 cm		6 272	6 533	7 478	7 852	8 166	9 554	12 937
MRVW120000	Profim REVO W120 • Screen, • wide 120 cm		7 957	8 289	9 544	10 022	10 423	12 194	16 511
MRVW180000	Profim REVO W180 • Screen, • wide 180 cm		10 645	11 089	13 011	13 607	14 199	16 566	22 509

26% rabatt ska dras av på angivna priser

Accessories/Options/Surcharges:

7ELEC004	Mediaport - electrical outlet 230V and 2 USB ports (Only for: P60, SN150, SN210, SW120, SW180, SW240)	2 655
7TFOA003	Flame retardant foam BS 5852 (Only for: B120, B180, B90, P40, P60, SN150, SN210, SW120, SW180, SW240)	

0 price group: Evo

1 price group: Cura, Tonal, Xtreme

2 price group: Select

3 price group: Capture, Oceanic, Step, Synergy

4 price group: Steelcut 3, Steelcut Trio 3

For Valencia and Silvertex (extended) fabrics - no quilting on the seat modules

Individual modules allow to create various types of systems / sets depending on your needs. A full list of possible configurations is available through the configurator on the website www.proffim.eu or directly at the link: [CONFIGURATOR pCon](#).

The price for a configured set is the amount of the value of each module of a given set.

Possibility to freely choose the type of upholstery for individual elements within a given set (e.g. seat: Select, backrest: Synergy, screen: Sprint).

The screens can only be combined with wide seats: SW120, SW160 or SW240.

It is not possible to purchase the screen as a free-standing module.



26% rabatt ska dras av på angivna priser

Profim SORRISO

Jarosław Szymański, Studio 1:1

- Three base options: cantilever, four-star base or flat base
- Möbelfakta certificate - a guarantee of durability, safety, environmental care and social responsibility during the production process

Item no	Base model +	Price Group (PG)	Price Group						Price
			0	①	②	③	④	⑤	
MSY100V000	Profim SORRISO 10V • armchair • wire frame • frame: black		5 334	5 912	6 962	7 233	9 452	8 614	11 387

Accessories/Options/Surcharges:

7SHQU006	Quilting - front side of the seat (Q5)	496
7CFRA051	Frame: MetallicPro	35

0 price group: Evo

1 price group: Cura, Tonal, Xtreme

2 price group: Select

3 price group: Capture, Oceanic, Step, Synergy

4 price group: Steelcut 3, Steelcut Trio 3

6 price group: Paloma

Castors / glides

Standard:

- teflon glides - universal

Option:

- felt glides - for hard floors

When ordering please clearly indicate the chosen option.

Option of mixing colours of the same fabric on shell and cushion according to below scheme:

A - cushion colour, B - shell colour.

In case of order of such option, following example should be specified: SC-67097/SC-60132 (where SC-67097 - A, SC-60132 - B). Option is available at no extra charge.



Quilting - extra charge to all price groups, lead time 30-40 working days.





26% rabatt ska dras av på angivna priser

Profim VANCOUVER LITE

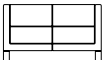
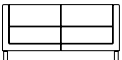
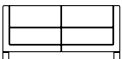
- Armchairs and sofas (in three sizes) come on metal cantilever and metal or wooden legs
- Complementary elements include a TV mount and media ports
- The collection is complemented by a simple wall which is used to connect the set in the shape of the letter "U"

Item no	Base model +	Price Group (PG)	Price Group						Price
			0	①	②	③	④	⑤	
MVT100H000	Profim VANCOUVER LITE VL1 H • armchair • legs • frame: black / MetallicPro / wooden legs		5 897	6 143	6 758	7 066	7 372	8 601	9 217
MVT100V000	Profim VANCOUVER LITE VL1 V • armchair • cantilevers • frame: black / MetallicPro		6 404	6 671	7 337	7 671	8 004	9 339	10 005
MVT200H000	Profim VANCOUVER LITE VL2 H • 2-seat sofa • legs • frame: black / MetallicPro / wooden legs		7 347	7 653	8 417	10 880	14 608	10 714	11 478
MVT200V000	Profim VANCOUVER LITE VL2 V • 2-seat sofa • cantilevers • frame: black / MetallicPro		7 853	8 180	8 997	9 406	9 815	11 451	12 270
MVT250H000	Profim VANCOUVER LITE VL2,5H • 2,5-seat sofa • legs • frame: black / MetallicPro / wooden legs		8 270	8 615	9 476	9 908	10 338	12 061	12 923
MVT250V000	Profim VANCOUVER LITE VL2,5V • 2,5-seat sofa • cantilevers • frame: black / MetallicPro		8 708	9 143	10 057	10 515	10 970	12 800	13 714

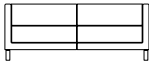
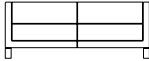
26% rabatt ska dras av på angivna priser

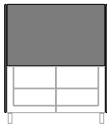
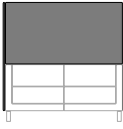
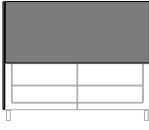
Item no	Base model +	Price Group (PG)	Price Group						Price
			0	①	②	③	④	⑤	
MVT300H000	Profim VANCOUVER LITE VL3 H • 3-seat sofa • legs • frame: black / MetallicPro / wooden legs		10 148	12 473	14 821	12 312	12 846	14 987	16 059
MVT300V000	Profim VANCOUVER LITE VL3 V • 3-seat sofa • cantilevers • frame: black / MetallicPro		10 784	11 233	12 357	12 919	13 479	15 727	16 849
MVTSW00000	Profim VANCOUVER LITE VL SW • straight connecting wall		2 112	2 200	2 420	2 529	2 639	3 078	
MVTW100000	Profim VANCOUVER LITE VL W1 • set of partition walls to be connected with armchair		6 839	7 124	7 838	8 194	8 551	9 975	
MVTW200000	Profim VANCOUVER LITE VL W2 • set of partition walls to be connected with 2-seater sofa		7 764	8 088	8 899	9 303	9 705	11 324	
MVTW250000	Profim VANCOUVER LITE VL W2,5 • set of partition walls to be connected with 2,5-seater sofa		8 848	9 217	10 136	10 599	11 059	12 901	
MVTW300000	Profim VANCOUVER LITE VL W3 • set of partition walls to be connected with 3-seater sofa		11 028	11 488	12 635	13 211	13 785	16 082	

26% rabatt ska dras av på angivna priser

Accessories/Options/Surcharges:

7TFRA013	Connecting with walls (HW/VW) (Only for: VL1 H, VL1 V)	425
7TFRA013	Connecting with walls (HW/VW) (Only for: VL2 H, VL2 V)	743
7TFRA013	Connecting with walls (HW/VW) (Only for: VL2,5H, VL2,5V, VL3 H, VL3 V)	991
7QUEL004	Quilting - inner surface (Q6) (Only for: VL SW)	2549
7QUEL004	Quilting - inner surface (Q6) (Only for: VL W1)	2926
7QUEL004	Quilting - inner surface (Q6) (Only for: VL W2)	4059
7QUEL004	Quilting - inner surface (Q6) (Only for: VL W2,5)	4626
7QUEL004	Quilting - inner surface (Q6) (Only for: VL W3)	10384
7QUEL006	Quilting - outer surface (Q7) (Only for: VL1 H, VL1 V)	1227
7QUEL006	Quilting - outer surface (Q7) (Only for: VL2 H, VL2 V)	1605
7QUEL006	Quilting - outer surface (Q7) (Only for: VL2,5H, VL2,5V)	1782
7QUEL006	Quilting - outer surface (Q7) (Only for: VL3 H, VL3 V)	2266
7QUEL006	Quilting - outer surface (Q7) (Only for: VL SW)	3009
7QUEL006	Quilting - outer surface (Q7) (Only for: VL W1)	3599
7QUEL006	Quilting - outer surface (Q7) (Only for: VL W2)	4921
7QUEL006	Quilting - outer surface (Q7) (Only for: VL W2,5)	5463
7QUEL006	Quilting - outer surface (Q7) (Only for: VL W3)	12650
7TFRA016	TV handle (SW HA) (Only for: VL SW)	2018
7ELEC004	Mediaport - electrical outlet 230V and 2 USB ports (Only for: VL1 H, VL1 V, VL2 H, VL2 V, VL2,5H, VL2,5V, VL3 H, VL3 V)	2655

0 price group: Evo

1 price group: Cura, Tonal, Xtreme

2 price group: Select

3 price group: Capture, Oceanic, Step, Synergy

4 price group: Steelcut 3, Steelcut Trio 3

6 price group: Paloma

Glides

Standard:

- hard glides - for soft floors (models H)

- felt pads - for hard floors (models V)

Option:

- felt glides - for hard floors (models H)

When ordering please clearly indicate the chosen option.

Wooden legs: beech wood - H5, H6, H12.

In VL W1, VL W2, VL W2,5, VL W3 option of mixing colours of the same fabric on inner and outer part of the partition wall according to below scheme:

A - inner part of shell, B - outer part of shell.

In case of order of such option, following example should be specified: SC-67097/SC-60132 (gdzie SC-67097 - A, SC-60132 - B). Option is available at no extra charge.

While ordering set of "U-shape" armchairs/sofas (including wall VL SW) please indicate clearly this option on your order. Distance between the seats in "U-shape set" - 940 mm.

Quilting - extra charge to all price groups, lead time 30-40 working days.

SW HA - acceptable dimension of TV: max. diagonal of the screen - 40 inches, max. weight - 10 kg.



26% rabatt ska dras av på angivna priser

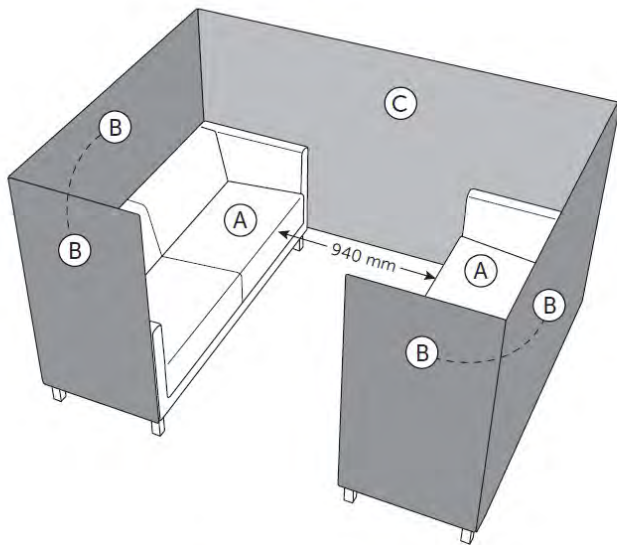

Sample of „U-shape” set with 3-seater sofas.

2 x A: VL 3 HW/VW
(3-seat sofa, to be connected with partition walls)

2x B: VL W3
(set of partition walls to be connected with 3-seater sofa)

1 x SW: VL SW
(wall)

While ordering set of "U-shape" armchairs/sofas (including wall VL SW) please indicate clearly this option on your order.

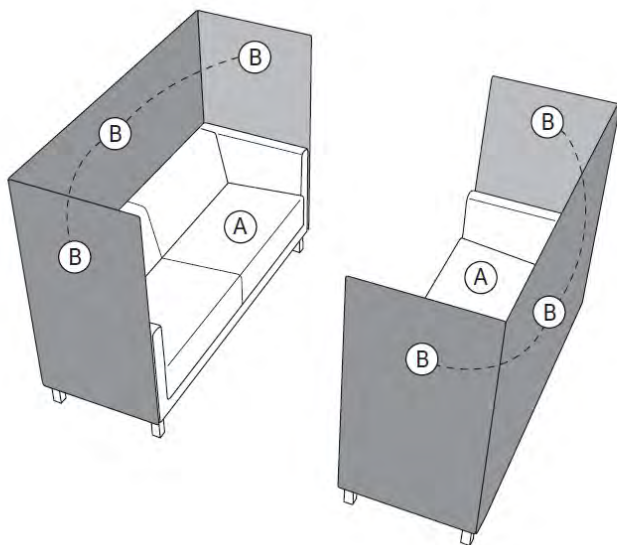









Sample of set with separate 3-seater sofas.

2 x A: VL 3 HW/VW
(3-seat sofa, to be connected with partition walls)

2 x B: VL W3
(set of partition walls to be connected with 3-seater sofa).

Profim VANCOUVER OTO

- Available in two sizes and two shapes
- The set is also available as a pouffe + table in the version with an added glass top
- Possibility of connecting cubic pouffes by means of a linking element
- The mediaport is a complementary element

Item no	Base model +	Price Group (PG)	Price Group						Price
			0	①	②	③	④	⑤	
MVOR200000	Profim VANCOUVER OTO VOR2 • small round pouffe • ø 410 mm	 	1 710	1 781	1 960	2 048	2 137	2 493	2 673
MVOR100000	Profim VANCOUVER OTO VOR1 • large round pouffe • ø 540 mm	 	1 904	1 983	2 179	2 278	2 378	2 774	2 972
MVOS200000	Profim VANCOUVER OTO VOS2 • small square pouffe • 410 x 410 mm	 	1 864	2 148	2 714	2 132	2 224	3 552	4 909
MVOS100000	Profim VANCOUVER OTO VOS1 • large square pouffe • 540 x 540 mm	 	2 163	2 253	2 479	2 593	2 705	3 155	3 380

Accessories/Options/Surcharges:

7TATO002	Table top milky tempered glass (Only for: VOR1, VOR2)	944
7TATO002	Table top milky tempered glass (Only for: VOS1, VOS2)	1 097
7ELEC004	Mediaport - electrical outlet 230V and 2 USB ports (Only for: VOS1, VOS2)	2 655
7QUEL006	Quilting - outer surface (Q7)	1 038

0 price group: Evo

1 price group: Cura, Tonal, Xtreme

2 price group: Select

3 price group: Capture, Oceanic, Step, Synergy

4 price group: Steelcut 3, Steelcut Trio 3

6 price group: Paloma

Glides

Standard:

- hard glides - for soft floors.

Option:

26% rabatt ska dras av på angivna priser

- felt glides - for hard floors.

When ordering please clearly indicate the chosen option.

Table top G1 - lead time 20-30 working days.

Quilting - extra charge to all price groups, lead time 30-40 working days.



26% rabatt ska dras av på angivna priser





Profim WALL IN

Tomek Rygalik, Studio Rygalik

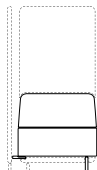
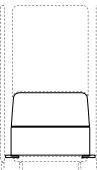

- Walls enabling the division of the interior and the introduction of distance
- Possibility to choose upholstery colour
- Legs finished with aesthetic plates, available in three colours
- The mediaport is a complementary element

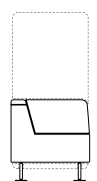
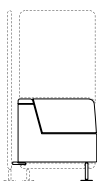
Item no	Base model +	Price Group (PG)	Price Group						Price
			0	①	②	③	④	⑤	
MWA1000000	Profim WALL IN 10 • pouffe • frame: black / MetallicPro		4 136	4 308	4 738	4 953	5 170	6 030	6 463
MWA1100000	Profim WALL IN 11 • pouffe to be connected with 1 partition wall • frame: black / MetallicPro		4 136	4 308	4 738	4 953	5 170	6 030	6 463
MWA1200000	Profim WALL IN 12 • pouffe to be connected with 2 partition walls • frame: black / MetallicPro		4 274	4 452	4 897	5 122	5 342	6 234	6 679
MWA1300000	Profim WALL IN 13 • pouffe to be connected with 3 partition walls • frame: black / MetallicPro		4 274	4 452	4 897	5 122	5 342	6 234	6 679
MWA2000000	Profim WALL IN 20 • armchair • frame: black / MetallicPro		5 410	5 635	6 197	6 480	6 761	7 889	8 454
MWA2100000	Profim WALL IN 21 • armchair to be connected with 1 partition wall • frame: black / MetallicPro		5 410	5 635	6 197	6 480	6 761	7 889	8 454

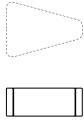
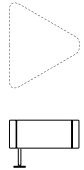
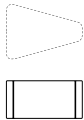
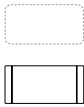
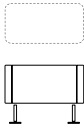

26% rabatt ska dras av på angivna priser

Item no	Base model +	Price Group (PG)	Price Group						Price
			0	①	②	③	④	⑤	
MWA2200000	Profim WALL IN 22 • armchair to be connected with 2 partition walls • frame: black / MetallicPro		5 549	5 780	6 357	6 646	6 937	8 091	8 670
MWA2300000	Profim WALL IN 23 • armchair to be connected with 3 partition walls • frame: black / MetallicPro		5 549	5 780	6 357	6 646	6 937	8 091	8 670
MWA3000000	Profim WALL IN 30 • corner armchair • frame: black / MetallicPro		6 177	6 434	7 078	7 399	7 721	9 009	9 651
MWA3100000	Profim WALL IN 31 • corner armchair to be connected with 1 partition wall • frame: black / MetallicPro		6 177	6 434	7 078	7 399	7 721	9 009	9 651
MWA3200000	Profim WALL IN 32 • corner armchair to be connected with 2 partition walls • frame: black / MetallicPro		6 317	6 580	7 238	7 567	7 895	9 212	9 870
MWAW110000	Profim WALL IN W11 • single partition wall to be connected with 1 seat • frame: black / MetallicPro		2 757	2 872	3 159	3 302	3 447	4 021	
MWAW120000	Profim WALL IN W12 • single partition wall to be connected with 2 seats • frame: black / MetallicPro		2 757	2 872	3 159	3 302	3 447	4 021	

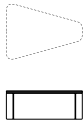
26% rabatt ska dras av på angivna priser

Item no	Base model +	Price Group (PG)	Price Group						Price
			0	①	②	③	④	⑤	
MWAC100000	Profim WALL IN C1 • pouffe • 30°connector		2530	2635	2899	3032	3162	3689	3954
MWAC200000	Profim WALL IN C2 • pouffe • 60°connector • frame: black / MetallicPro		3263	3399	3740	3908	4079	4757	5099
MWAP100000	Profim WALL IN P1 • pouffe • 30° armrest		2723	2836	3119	3262	3403	3969	4253
MWAP300000	Profim WALL IN P3 • pouffe • rectangular armrest		2460	2563	2819	2948	3076	3588	3846
MWAP400000	Profim WALL IN P4 • pouffe • rectangular armrest on legs • frame: black / MetallicPro		3282	3419	3759	3929	4101	4784	5125
MWAB000000	Profim WALL IN B • square table • frame: black / MetallicPro		4886	5090	5599	5852	6108	7124	7633
MWAB100000	Profim WALL IN B1 • table • 30°connector		6440	6708	7379	7713	8049	9388	10059

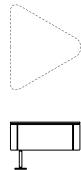
26% rabatt ska dras av på angivna priser

Item no	Base model +	Price Group (PG)	Price Group						Price
			0	①	②	③	④	⑤	
MWAB200000	Profim WALL IN B2 • table • 60°connector • frame: black / MetallicPro		5 026	5 235	5 759	6 021	6 282	7 329	7 851
MWABW10000	Profim WALL IN BW1 • square table to be connected with 1 partition wall • frame: black / MetallicPro		6 440	6 708	7 379	7 713	8 049	9 388	10 059
MWABW20000	Profim WALL IN BW2 • square table to be connected with 2 partition walls • frame: black / MetallicPro		4 886	5 090	5 599	5 852	6 108	7 124	7 633

Accessories/Options/Surcharges:

	Table top HPL (Only for: B, BW1, BW2)	1 923
	Table top HPL (Only for: B1)	1 605
	Table top HPL (Only for: B2)	2 242
7JIRO001	Possibility of joining in rows	47
7ELEC004	Mediaport - electrical outlet 230V and 2 USB ports (Only for: 10, 11, 12, 13, 20, 21, 22, 23, 30, 31, 32)	2 714
7QUEL004	Quilting - inner surface (Q6) (Only for: 10, 11, 12, 13, C2)	555
7QUEL004	Quilting - inner surface (Q6) (Only for: 20, 21, 22, 23)	684
7QUEL004	Quilting - inner surface (Q6) (Only for: 30, 31, 32)	767
7QUEL004	Quilting - inner surface (Q6) (Only for: C1, P1, P3, P4)	401

0 price group: Evo

1 price group: Cura, Tonal, Xtreme

2 price group: Select

3 price group: Capture, Oceanic, Step, Synergy

4 price group: Steelcut 3, Steelcut Trio 3

6 price group: Paloma

Glides

Standard:

- metal glides - for soft floors.

Option:

- felt glides - for hard floors.

When ordering please clearly indicate the chosen option.

Model P4 (on legs) allows the completion of any system.

Glides and linking parts for partition walls are provided with the seat to be connected with the partition wall.

Wall In W11/W12 models never occur as freestanding elements.

26% rabatt ska dras av på angivna priser

Table top G1 - lead time 20-30 working days.

Colours of HPL (LW): White (LW01), Light Grey (LW03); Grey (LW04), Black (LW02), Navy Blue (LW06), Light Burgundy (LW07) - lead time 20-30 working days.

Quilting - extra charge to all price groups, lead time 30-40 working days.



26% rabatt ska dras av på angivna priser

Tables







Coat stands

Accessories







26% rabatt ska dras av på angivna priser

Profim Allround





- Table top in Laminate and Linoleum (24 mm) or Melamine Beech (22 mm)
- Table edge band will match table top colour as standard. Optionally choose black, white or grey table edge band to any table top colour within our range without extra charge.

Item no	Base model +	Price Group (PG)	①	②	③	Price
5180-30	Profim Allround 5180-30 (E) <ul style="list-style-type: none"> • Tables, height 73/90 cm • 80 x 80 cm with column frame base with 4 star footbase 		3 151	4 255	5 531	
5180-10	Profim Allround 5180-10 (E) <ul style="list-style-type: none"> • Table, height 73/90 cm • 180 x 90 cm with T frame • Distance between legs 110 cm 		4 662	7 086	9 212	
5180-22	Profim Allround 5180-22 (S) <ul style="list-style-type: none"> • Table, height 73/90 cm • 180 x 80 cm with T frame • Distance between table legs 110 cm 		4 540	6 730	8 749	
5180-24	Profim Allround 5180-24 (E) <ul style="list-style-type: none"> • Table, height 73/90 cm • 160 x 80 cm with T frame • Distance between table legs 110 cm 		4 422	6 401	8 322	
5180-25	Profim Allround 5180-25 (S) <ul style="list-style-type: none"> • Table, height 73/90 cm • 140 x 80 cm with T frame • Distance between table legs 80 cm • Weight approx. 24.5 kg Lam. 		4 307	6 311	8 204	
5180-27	Profim Allround 5180-27 (S) <ul style="list-style-type: none"> • Table, height 73/90 cm • 120 x 80 cm with T frame • Distance between table legs 80 cm 		4 222	6 107	7 938	

26% rabatt ska dras av på angivna priser

Item no	Base model +	Price Group (PG)	①	②	③	Price
5180-36	Profim Allround 5180-36 (E) <ul style="list-style-type: none"> • Table, height 73/90 cm • 180 x 70 cm with T frame • Distance between table legs 110 cm 		4 422	6 376	8 289	
5180-38	Profim Allround 5180-38 (S) <ul style="list-style-type: none"> • Table, height 73/90 cm • 140 x 70 cm with T frame • Distance between table legs 80 cm 		4 246	6 165	8 015	
5180-39	Profim Allround 5180-39 (S) <ul style="list-style-type: none"> • Table, height 73/90 cm • 120 x 70 cm with T frame • Distance between table legs 80 cm 		4 136	5 822	7 568	
5182-10	Profim Allround 5182-10 (E) <ul style="list-style-type: none"> • Round table with frame base, height 50/73 cm • Ø60 cm - 4 star footbase 		3 135	4 427	5 755	
5182-102	Profim Allround 5182-102 (E) <ul style="list-style-type: none"> • High table, height 90/110 cm • Ø60 cm - 4 star footbase 		3 344	4 590	5 967	
5182-15	Profim Allround 5182-15 (S) <ul style="list-style-type: none"> • Round table with frame base, height 50/73 cm • Ø70 cm - 4 star footbase 		3 291	4 650	6 045	
5182-152	Profim Allround 5182-152 (E) <ul style="list-style-type: none"> • High table, height 90/110 cm • Ø70 cm - 4 star footbase 		3 452	4 810	6 253	

26% rabatt ska dras av på angivna priser

Item no	Base model +	Price Group (PG)	①	②	③	Price
5182-20	Profim Allround 5182-20 (E) • Round table with frame base, height 50/73 cm • Ø80 cm - 4 star footbase		3 492	4 929	6 408	
5182-202	Profim Allround 5182-202 (E) • High table, height 90/110 cm • Ø80 cm - 4 star footbase		3 657	5 089	6 615	
5182-25	Profim Allround 5182-25 (E) • Round table with frame base, height 50/73 cm • Ø100 cm - 5 star footbase		4 003	5 736	7 456	
5182-30	Profim Allround 5182-30 (E) • Round table with frame base, height 50/73 cm • Ø120 cm - 5 star footbase		4 326	6 411	8 334	
5184-01	Profim Allround 5184-01 (E) • Ellipse table • Height 73/90 cm • 180 x 100 cm with T frame, seats 6 • Distance between table legs 110 cm		5 883	8 039	10 451	

Accessories/Options/Surcharges:

	Add price for MDF, chamfer edge and 10 mm table top edge band in std colours. +20% on equivalent size/model in laminate	Price on request
RS091003	Linking device with screws, not mounted, see below. Available for rectangular table w/ straight edged table top Per set. We recommend 1 set for short table sides and 2 sets for longer table sides	139

1. Melamine on chipboard (only beech)

2. Laminate on chipboard

3. Linoleum on chipboard

Height: 50/73/90/110 cm

Profim Allround table tops (rectangular and squared shapes) can be made available with MDF table core, chamfered edges of 20 degr and with a 10 mm black, white or grey edge band and black paint

26% rabatt ska dras av på angivna priser

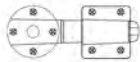

RS091003



S=Standard Collection - normal production time 20-30 working days. Applicable when table top and base are standard (S).





E=Extended Collection - normal production time 30-35 working days (Linoleum: 35 working days). Applicable when any or all component options selected are extended (E).

For larger orders, please contact Customer Service for delivery details.







Profim Eminent

- Ø38 mm tubular table leg in various colours. See below Accessories/options. Incl. levelling feet (up to 17 mm on all legs)
- Table tops in various colours, see below Accessories/options.
- Table edge band will match table top colour as standard. Optionally choose black, white or grey table edge band to any table top colour within our range without extra charge.
- Table suspension brackets for several tables available for Profim Ana and Noor (except 6080/85). Cannot be attached to round tables

Item no	Base model +	Price Group (PG)	①	②	③	Price
4590-22	Profim Eminent 4590-22 (S) <ul style="list-style-type: none"> • 180 x 80 cm • Distance between the table legs 164 cm • Weight appr 33.2 kg Lam. 		4 511	5 562	7 230	
4590-24	Profim Eminent 4590-24 (S) <ul style="list-style-type: none"> • 160 x 80 cm • Distance between the table legs 144 cm • Weight appr 29.8 kg Lam. 		4 278	5 134	6 674	
4590-25	Profim Eminent 4590-25 (S) <ul style="list-style-type: none"> • 140 x 80 cm • Distance between the table legs 124 cm • Weight appr 27.3 kg Lam. 		4 291	5 146	6 691	
4590-27	Profim Eminent 4590-27 (S) <ul style="list-style-type: none"> • 120 x 80 cm • Distance between the table legs 104 cm • Weight appr 24.2 kg Lam. 		3 756	4 546	5 911	
4590-30	Profim Eminent 4590-30 (E) <ul style="list-style-type: none"> • 80 x 80 cm • Distance between the table legs 64 cm • Weight appr 18.7 kg Lam. 		3 237	3 945	5 129	

26% rabatt ska dras av på angivna priser

Item no	Base model +	Price Group (PG)	①	②	③	Price
4590-38	Profim Eminent 4590-38 (S) <ul style="list-style-type: none"> • 140 x 70 cm • Distance between the table legs 124 cm • Weight appr 25.2 kg Lam. 		4 219	5 060	6 578	
4590-52	Profim Eminent 4590-52 (E) <ul style="list-style-type: none"> • 140 x 60 cm • Distance between the table legs 124 cm • Weight appr 23 kg Lam. 		4 045	4 881	6 346	
4590-54	Profim Eminent 4590-54 (S) <ul style="list-style-type: none"> • 120 x 60 cm • Distance between the table legs 104 cm • Weight appr 20.4 kg Lam. 		3 155	4 121	5 357	
4592-30	Profim Eminent 4592-30 (E) <ul style="list-style-type: none"> • Ø120 cm with 4 legs • Distance between the table legs 60 cm 		4 206	5 880	7 644	
4592-50	Profim Eminent 4592-50 (E) <ul style="list-style-type: none"> • Ø160 cm with 4 legs • Distance between the table legs 91 cm 		6 486			
4593-15	Profim Eminent 4593-15 (E) <ul style="list-style-type: none"> • Trapezium 140 x 70 x 70 x 70, depth 60 cm • Distance between the table legs 116/53/60 cm 		4 387	5 261	6 839	
Accessories/Options/Surcharges:						
M130350	Bracket for 1 chair. Ana **					858
M130355	Bracket for 2 chairs. Ana**					1 167
M130360	Bracket for 2 chairs. Ana (One chair per table side)**					1 167

26% rabatt ska dras av på angivna priser

Accessories/Options/Surcharges:

M130365	Bracket for 4 chairs. Ana **	1513
M130370	Bracket for 6 chairs. Ana**	1887
M30410	Bracket for 1 chair. Noor**	352
M09502	Castors Eminent 4 pcs. Lockable	1770
M30403	Bracket for 1 chair. Eminent table - Com chair**	297

1. Melamine on chipboard (only beech)

2. Laminate on chipboard

3. Linoleum on chipboard

Table top in Laminate and Linoleum (24 mm) or Melamine Beech (22 mm)

Height approx. 73.5 cm. Table leg adjustment screw on legs

** See separate page "Table/chair suspension bracket system" for details



S=Standard Collection - normal production time 20-30 working days. Applicable when table top and base are standard (S).

E=Extended Collection - normal production time 30-35 working days (Linoleum: 35 working days). Applicable when any or all component options selected are extended (E).

For larger orders, please contact Customer Service for delivery details.

Table/chair suspension bracket system for Eminent table

Table size (Length x width)	Width between legs (width chair)	Noor 6050/6055* (M30410 Bracket)	Noor 6060/6065* (M30410 Bracket)	Noor 6070/6075* (M30410 Bracket)	Ana	Com H/V (M30403 Bracket)
1200x600	1046x(446)	1	1	1	1 (M130350)	1 or 2
800x800	646x(646)	1 on both sides	1 on both sides	1 on both sides	2 on same side (M130355)	1 on both sides
1200x800	1046	1 on both sides	1 on both sides	1 or 2 on both sides	2 (1 on both sides) (M130360)	1 or 2 on both sides
1400x600	1246	1 or 2 on one side	1 or 2 on one side	1 or 2 on one side	4 (2 on both sides) (M130365)	1 or 2
1400x700	1246	1 or 2 on both sides	1 or 2 on both sides	1 or 2 on both sides	-	1 or 2 on both sides
1400x800	1246	1 or 2 on both sides	1 or 2 on both sides	1 or 2 on both sides	-	1 or 2 on both sides
1600x800	1446	1 or 2 on both sides	1 or 2 on both sides	1 or 2 on both sides	-	1 or 2 on both sides
1800x800	1646	1, 2 or 3 on both sides	1 or 2 on both sides	1 or 2 on both sides	6 (3 on both sides) (M130370)	1, 2 or 3 on both sides



* Valid for unupholstered chair, upholstered Seat (S), upholstered Seat and Back (SB) and Fully upholstered (F) variants. Table suspension bracket not applicable for Noor 6080/6085

26% rabatt ska dras av på angivna priser



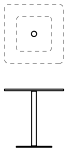
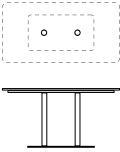
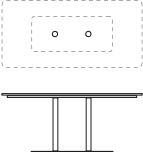

Profim REVO TABLES

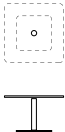
Pearson Lloyd

- tables and table frames of different length and height and shape
- designed with comfort in mind
- versatile and lightweight design
- various color palette of table tops and frames

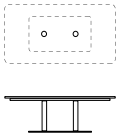
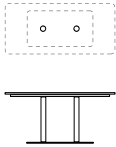
Item no	Base model +	Price Group (PG)	①	②	Price
MRVT750000	Profim REVO T75 • table 750 x 750 mm • height 740 mm • square, flat base		8 390	8 933	
MRVT150000	Profim REVO T150 • table 1500 x 750 mm • height 740 mm • rectangular, flat base		15 718	16 461	
MRVT180000	Profim REVO T180 • table 1800 x 850 mm • height 740 mm • rectangular, flat base		18 101	19 718	
MRVLS65000	Profim REVO LS65 • table 650 x 350 mm • height 665 mm • rectangular, flat base		5 640	5 994	
MRVLR48000	Profim REVO LR48 • table round Ø 480 mm • height 665 mm • round base, flat base		5 640	5 994	
MRVC750000	Profim REVO C75 • low table 750 x 750 mm • height 450 mm • square, flat base		8 130	8 685	

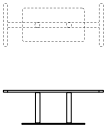
26% rabatt ska dras av på angivna priser

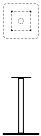
Item no	Base model +	Price Group (PG)	①	②	Price
MRVC150000	Profim REVO C150 • low table 1500 x 750 mm • height 450 mm • rectangular, flat base		15 187	15 918	
MRVT140000	Profim REVO MT140 • medium table 1400 x 700 mm • height 650 mm • rectangular, flat base		12 203	12 766	
MRVC75000F	Profim REVO FRAME C75 • table's frame • height 440 mm • square, flat base				5 100
MRVC15000F	Profim REVO FRAME C150 • table's frame • height 440 mm • rectangular, flat base				9 860
MRVLR4800F	Profim REVO FRAME LR48 • table's frame • height 655 mm • round base, flat base				4 170
MRVLS6500F	Profim REVO FRAME LS65 • table's frame • height 655 mm • rectangular, flat base				4 330
MRVT75000F	Profim REVO FRAME T75 • table's frame • height 730 mm • square, flat base				5 500

26% rabatt ska dras av på angivna priser

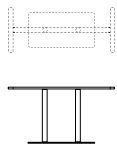
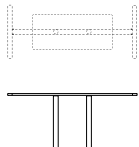
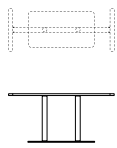
Item no	Base model +	Price Group (PG)	①	②	Price
MRVT15000F	Profim REVO FRAME T150 • table's frame • height 730 mm • rectangular, flat base				10770
MRVT18000F	Profim REVO TABLES FRAME T180 • table's frame • height 730 mm • rectangular, flat base				12230
MRVT14000F	Profim REVO FRAME MT140 • table's frame • height 640 mm • rectangular, flat base				10500

26% rabatt ska dras av på angivna priser

1. Natural veneers / Natural colored veneers (ash)Frame

2. HPL

MetallicPro; Black RAL 9005; White RAL 9016; Light Grey NCS S 2500 N; Grey NCS S 6500 N; Deep Green RAL 6004; Navy Blue RAL 5003; Burgundy RAL 3005; Salvia/Green RAL 6021, Blue RAL 5014; Terracota RAL 3012

Natural veneers

Ash (NA), Beech (NB), Oak (NO), Walnut (NW)

Natural colored veneers (ash)

White (CNA01), Black (CNA02), Dark green (CNA05), Navy blue (CNA06), Burgundy (CNA07)

HPL

White (LW01), Light Grey (LW03); Grey (LW04), Black (LW02), Navy Blue (LW06), Light Burgundy (LW07)

There is a possibility of any combination of the top and frame colors.

Natural veneers: Ash (NA); Beech (NB); Oak (NO); Orzech (NW) - delivery time 30 business days.

Natural colored veneers: delivery time 30 business days.

HPL worktops: delivery time 30 business days.

Frame in Revo Tables is dedicated for assembly table tops made only from chipboard, plywood or wood.

Maximum parameters of the table top:

C75- 750 x 750 mm, weight 4kg.

C150 - 1500 x 750 mm, weight 8 kg.

LR48 - Ø 480 mm, weight 1,5 kg.

LS65 - 350 x 650 mm, weight 2kg

T75 - 750 x 750 mm, weight 4kg.





T150 - 1500 x 750 mm, weight 8 kg.

T180 - 1800 x 850 mm, weight 11kg.

MT140 - 1400 x 700 mm, weight 7kg.

Profim Standard Folding Table

- Folding table - 100 mm height when collapsed (with 22 mm table top)
- Frame in various colours. See below Accessories/options.
- For table top colours, see below Accessories/options.
- Table top edge band will match table top as standard. Optionally choose black, white or grey table edge band to any table top colour within our range without extra charge.
- Table top in Laminate (24 mm) or Melamine Beech (22 mm)

Item no	Base model +	Price Group (PG)	①	②	Price
4680-10	Profim Standard 4680-10 (E) <ul style="list-style-type: none"> • 180 x 90 cm • Distance between the table legs 103 cm • Weight appr 30.9 kg Lam. 		3 649	5 451	
4680-15	Profim Standard 4680-15 (S) <ul style="list-style-type: none"> • 120 x 90 cm • Distance between the table legs 103 cm • Weight appr 22.6 kg Lam. 		3 140	4 420	
4680-22	Profim Standard 4680-22 (S) <ul style="list-style-type: none"> • 180 x 80 cm • Distance between the table legs 103 cm • Weight appr 28.1 kg Lam. 		3 172	5 053	
4680-24	Profim Standard 4680-24 (S) <ul style="list-style-type: none"> • 160 x 80 cm • Distance between the table legs 103 cm • Weight appr 25.7 kg Lam. 		3 077	4 737	
4680-25	Profim Standard 4680-25 (S) <ul style="list-style-type: none"> • 140 x 80 cm • Distance between the table legs 103 cm • Weight appr 23.2 kg Lam. 		3 040	4 432	

26% rabatt ska dras av på angivna priser

Item no	Base model +	Price Group (PG)	①	②	Price
4680-27	Profim Standard 4680-27 (S) <ul style="list-style-type: none"> • 120 x 80 cm • Distance between the table legs 103 cm • Weight appr 20.8 kg Lam. 		2629	4074	
4680-36	Profim Standard 4680-36 (E) <ul style="list-style-type: none"> • 180 x 70 cm • Distance between the table legs 103 cm • Weight appr 25.4 kg Lam. 		3077	4488	
4680-38	Profim Standard 4680-38 (S) <ul style="list-style-type: none"> • 140 x 70 cm • Distance between the table legs 103 cm • Weight appr 21.1 kg Lam. 		2785	4003	
4680-39	Profim Standard 4680-39 (S) <ul style="list-style-type: none"> • 120 x 70 cm • Distance between the table legs 103 cm • Weight appr 18.9 kg Lam. 		2629	3846	
4680-52	Profim Standard 4680-52 (S) <ul style="list-style-type: none"> • 140 x 60 cm • Distance between the table legs 103 cm • Weight appr 18.9 kg Lam. 		2933	4032	
4680-54	Profim Standard 4680-54 (S) <ul style="list-style-type: none"> • 120 x 60 cm • Distance between the table legs 103 cm • Weight appr 17.1 kg Lam. 		2430	3638	

26% rabatt ska dras av på angivna priser

Item no	Base model +	Price Group (PG)	①	②	Price
4680-58	Profim Standard 4680-58 (S) <ul style="list-style-type: none"> Exam table 90 x 60 cm Distance between the table legs 75 cm Weight appr 14.3 kg Lam. 		2190	3077	
4680-90	Profim Standard 4680-90 (S) <ul style="list-style-type: none"> 120 x 45 cm Distance between the table legs 103 cm Weight appr 14.3 kg Lam. 		2261	3210	
4681-45	Profim Standard 4681-45 (E) <ul style="list-style-type: none"> 1/2 circle with folding frame, Ø160 cm Distance between the table legs 74 cm 		3490	5343	
4688-52	Profim Standard 4688-52 (E) <ul style="list-style-type: none"> L-frame 140 x 60 cm Distance between the table legs 103 cm Weight appr 18.9 kg Lam. 		2933	4032	
4688-54	Profim Standard 4688-54 (E) <ul style="list-style-type: none"> L-frame 120 x 60 cm Distance between the table legs 103 cm Weight appr 17.1 kg Lam. 		2430	3638	
4688-90	Profim Standard 4688-90 (E) <ul style="list-style-type: none"> L-frame 120 x 45 cm Distance between the table legs 103 cm Weight appr 14.3 kg Lam. 		2261	3210	
Accessories/Options/Surcharges:					
4698-98	Front panel 120 x 20 cm. Not for tables with L-frame or 1/2 circle		979	1813	
4698-97	Front panel 120 x 30 cm. Not for tables with L-frame or 1/2 circle		1219	1964	
4698-90	Front panel 120 x 45 cm. Not for tables with L-frame or 1/2 circle		1219	2091	

26% rabatt ska dras av på angivna priser

Accessories/Options/Surcharges:

RS091003	Linking device with screws, not mounted, see below. Available for rectangular table w/ straight edged table top Per set. We recommend 1 set for short table sides and 2 sets for longer table sides	139
RS092064	Standard Folding table levelling screw	13
3211	Trolley 125 x 71 cm, (without drive bar and retainer for trolley), transport tables (7) standing or (12) lying down	7 655
3212	Trolley 200x71 cm (without drive bar and retainer for trolley), transport tables 13 Std. standing or 12 lying down	8 704
3213	Drive bar for trolley	2 772
3214	Retainer for trolley - requires 2 per trolley for transport of standing tables - price per unit	4 589

1. Melamine on chipboard (only beech)

2. Laminate on chipboard

Height, approx: 74.5 cm

Trolley with frame. 3211 for transport of 5 upright Profim Standard folding tables. 3212 for transport of 13 upright Profim Standard folding tables. Both trolleys can hold 12 tables lying down

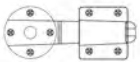

RS091003

S=Standard Collection - normal production time 20-30 working days. Applicable when table top and base are standard (S).

E=Extended Collection - normal production time 30-35 working days. Applicable when any or all component options selected are extended (E).

For larger orders, please contact Customer Service for delivery details.

Lightweight core on request.



26% rabatt ska dras av på angivna priser



Item no	Base model +	Price Group (PG)	Tempered glass (G1)	Price
MQC40H000F	Profim TABLES SH40 FRAME <ul style="list-style-type: none"> table's frame, low height 440 mm metal legs frame: black 			1770
MQC30H000F	Profim TABLES SH30 FRAME <ul style="list-style-type: none"> table's frame, medium height 590 mm metal legs frame: black 			1805
MQC40R000F	Profim TABLES SR40 FRAME <ul style="list-style-type: none"> table's frame, low height 440 mm round base base: black 			2230
MQC30R000F	Profim TABLES SR30 FRAME <ul style="list-style-type: none"> table's frame, medium height 590 mm round base base: black 			2266
Accessories/Options/Surcharges:				
	Oak wood - HO6, HO12, HO11 (Only for: SW40)			307
	Table top HPL (Only for: SH30, SR30, SH40, SR40)			1605
7COPR002	Frames colours: MetallicPro, White RAL 9016, Deep Green RAL 6004, Navy Blue RAL 5003, Burgundy RAL 3005, Salvia/Green RAL 6021, Blue RAL 5014, Terracota RAL 3012 (Only for: SH30, SR30, SR30 FRAME, SH40, SR40, SV40, SR40 FRAME)			35
7COPR003	Frames colours: Lightgrey NCS S 2500-N; Grey NCS S 6500-N (Only for: SH30, SR30, SH30 FRAME, SR30 FRAME, SH40, SR40, SV40, SH40 FRAME, SR40 FRAME)			212

Table top: tempered glass: G1 (milky)

Colours of HPL White (LW01), Light Grey (LW03); Grey (LW04), Black (LW02), Navy Blue (LW06), Light Burgundy (LW07) - lead time 20-30 working days.

Frame in Tables SH is dedicated for assembly table tops made only from chipboard, plywood or wood. Self-assembly is not possible in case of glass table tops. Maximum parameters of the table top: Ø 600 mm.

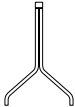

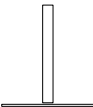

Frame in Tables SR is dedicated for assembly table tops made only from chipboard, plywood or wood. Self-assembly is not possible in case of glass table tops. Maximum parameters of the table top: Ø 900 mm, weight 7,0 kg.

26% rabatt ska dras av på angivna priser





Profim u-Connect

Acer Design a/s, Justus Kolberg, Erik Simonsen

- Folding tables
- A smart mobile folding table with wheels and can nest together when lined up in the vertical position. The table top is anchored with a bracket in the upright position. The table top can be tipped along its long axis
- Table top edge band will match table top colour as standard. Optionally choose black, white or grey table edge band to any table top colour within our range without extra charge.
- Table top in Laminate or Linoleum (24 mm) and Melamine Beech (22 mm)

Item no	Base model +	Price Group (PG)	①	②	③	Price
3490-22	Profim u-Connect 3490-22 (S) <ul style="list-style-type: none"> • 180 x 80 cm • Distance between the table legs 163 cm • Weight appr 31.6 kg Lam. 		7 615	9 416	12 241	
3490-36	Profim u-Connect 3490-36 (S) <ul style="list-style-type: none"> • 180 x 70 cm • Distance between the table legs 163 cm • Weight appr 28.7 kg Lam. 		7 529	9 201	11 961	
3490-24	Profim u-Connect 3490-24 (S) <ul style="list-style-type: none"> • 160 x 80 cm • Distance between the table legs 143 cm • Weight appr 28.7 kg Lam. 		6 924	8 560	11 128	
3490-37	Profim u-Connect 3490-37 (S) <ul style="list-style-type: none"> • 160 x 70 cm • Distance between the table legs 143 cm • Weight appr 26.1 kg Lam. 		6 844	8 362	10 871	
3490-25	Profim u-Connect 3490-25 (S) <ul style="list-style-type: none"> • 140 x 80 cm • Distance between the table legs 123 cm • Weight appr 25.4 kg Lam. 		6 294	7 783	10 118	

26% rabatt ska dras av på angivna priser

Item no	Base model +	Price Group (PG)	①	②	③	Price
3490-38	Profim u-Connect 3490-38 (S) <ul style="list-style-type: none"> • 140 x 70 cm • Distance between the table legs 123 cm • Weight appr 23.2 kg Lam. 		6 223	7 608	9 890	
3490-52	Profim u-Connect 3490-52 (S) <ul style="list-style-type: none"> • 140 x 60 cm • Distance between the table legs 123 cm • Weight appr 21 kg Lam. 		6 150	7 473	9 715	
3490-27	Profim u-Connect 3490-27 (S) <ul style="list-style-type: none"> • 120 x 80 cm • Distance between the table legs 103 cm • Weight appr 22.6 kg Lam. 		6 198	7 568	9 839	
3490-39	Profim u-Connect 3490-39 (S) <ul style="list-style-type: none"> • 120 x 70 cm • Distance between the table legs 103 cm • Weight appr 21.6 kg Lam. 		6 321	7 415	9 640	
3490-54	Profim u-Connect 3490-54 (S) <ul style="list-style-type: none"> • 120 x 60 cm • Distance between the table legs 103 cm • Weight appr 18.5 kg Lam. 		6 079	7 261	9 439	

Accessories/Options/Surcharges:

	Add price for MDF, chamfer edge and 10 mm table top edge band in std colours.+20% on equivalent size/model in laminate	Price on request
	Additional price* for polished aluminium legs	1 133
115000338008	Linking device u-Connect, right (available for straight edged table top)	167
115000338009	Linking device u-Connect, left (available for straight edged table top)	167
105000348010	Cable clips, black plastic	15

1. Melamine on chipboard (only beech)
2. Laminate on chipboard
3. Linoleum on chipboard

26% rabatt ska dras av på angivna priser

Height 73.5 cm

Features Ø65 mm castors with soft rim and brake

Profim u-Connect table tops (rectangular and squared shapes) can be made available with MDF table core, chamfered edges of 20 degr and with a 10 mm black, white or grey edge band and black paint (see extra charge below)



RBM u-Connect



115000338008

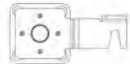

115000338009



S=Standard Collection – normal production time 20-30 working days. Applicable when table top and base are standard (S).

E=Extended Collection – normal production time 30-35 working days (Linoleum: 35 working days). Applicable when any or all component options selected are extended (E).

For larger orders, please contact Customer Service for delivery details.

Lightweight core on request.



MÖBELFAKTA

26% rabatt ska dras av på angivna priser

Profim SEVEN

Tomek Rygalik, Studio Rygalik

- Option of combining colours, it is possible to play with colours (hanger and hooks are available in different shades)

Item no	Base model +	Price Group (PG)	Coat hanger	Price
MSZ0000000	Profim SEVEN • coat hanger			1944

Hard glides - for soft floors (set).

Colours of frame:



- Black RAL 9005
- MetallicPro
- White RAL 9016
- Lightgrey NCS S 2500-N
- Grey NCS S 6500-N
- Deep green RAL 6004
- Navy blue RAL 5003
- Burgundy RAL 3005
- Salvia/Green RAL 6021
- Blue RAL 5014
- Terracota RAL 3012
- Steelgray

It is possible to order hooks in different colour than the coat stand frame.

26% rabatt ska dras av på angivna priser

Profim CUSHION

- Two sizes
- Several types of fabric

Item no	Base model +	Price Group (PG)	①	②	③	④	Price
MCU3000000	Profim CUSHION CU30 • cushions with filling • 300 x 300 mm		448	696	732	1 097	
MCU4000000	Profim CUSHION CU40 • cushions with filling • 400 x 400 mm		531	767	802	1 286	

1 price group: Cura, Tonal, Xtreme

2 price group: Select

3 price group: Capture, Oceanic, Step, Synergy

4 price group: Steelcut 3, Steelcut Trio 3

Filling: silicon.

Weight:

CU30 - 0,15 kg,

CU40 - 0,25 kg.

Colour of pillowcase is always white.

26% rabatt ska dras av på angivna priser

Technical details

Allround

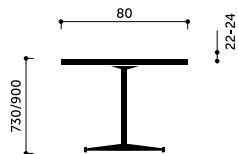

Allround 5180-30

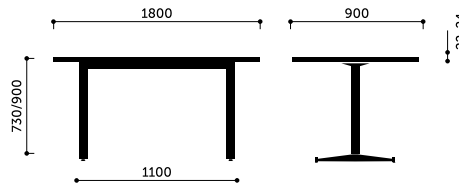

Allround 5180-10

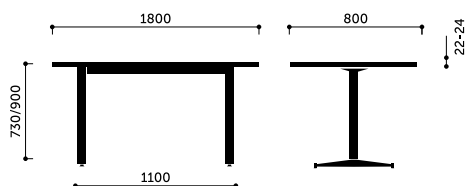

Allround 5180-22

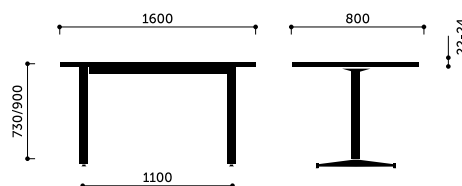

Allround 5180-24

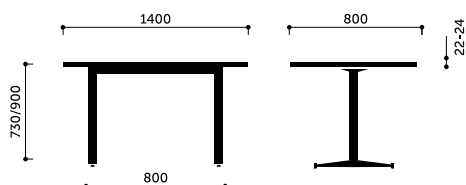

Allround 5180-25

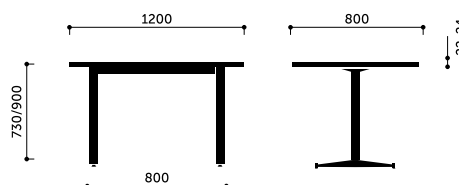

Allround 5180-27

Technical details

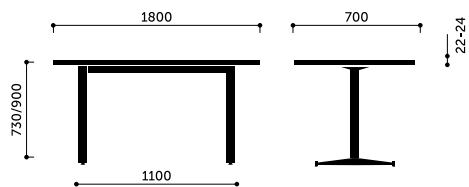

Allround 5180-36

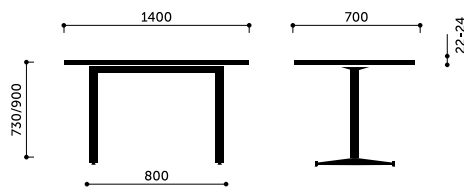

Allround 5180-38

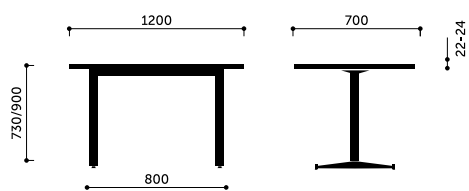

Allround 5180-39

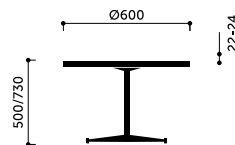

Allround 5182-10

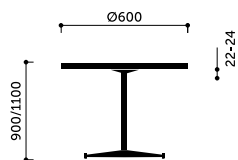

Allround 5182-102

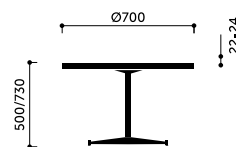

Allround 5182-15

26% rabatt ska dras av på angivna priser

Technical details

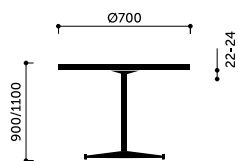

Allround 5182-152

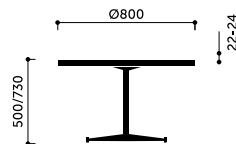

Allround 5182-20

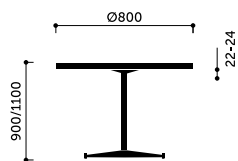

Allround 5182-202

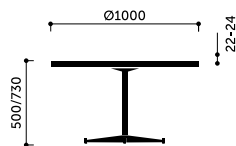

Allround 5182-25

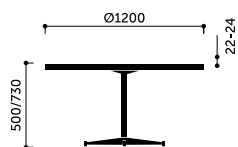

Allround 5182-30

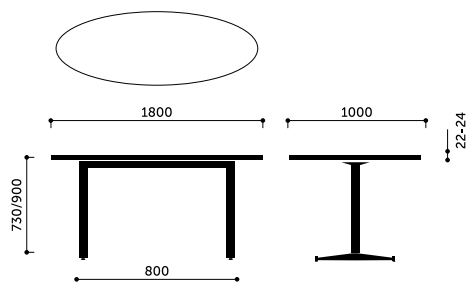

Allround 5184-01

Technical details

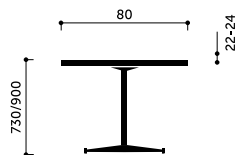

Allround 5180-30

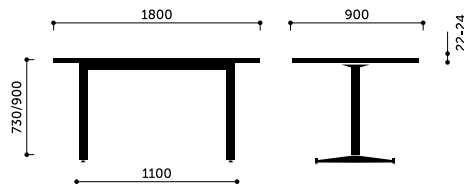

Allround 5180-10

Ana

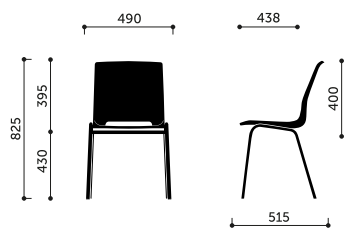

4340 / 4340S / 4340SR

26% rabatt ska dras av på angivna priser

Technical details

Ariz

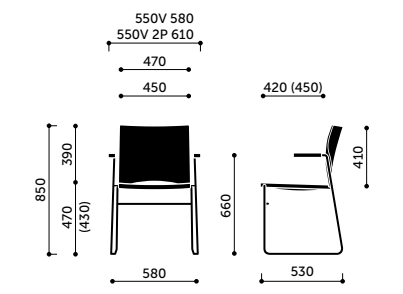

550V / 550V 2P

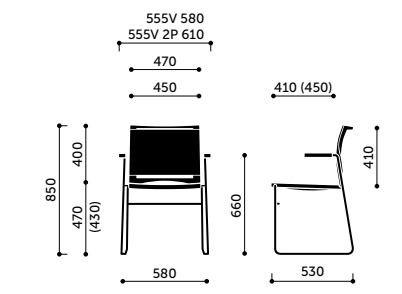
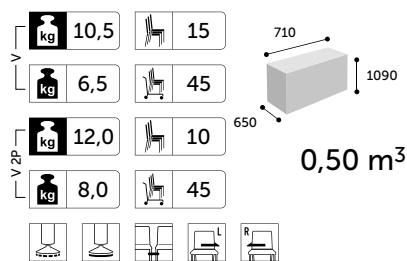

555V / 555V 2P

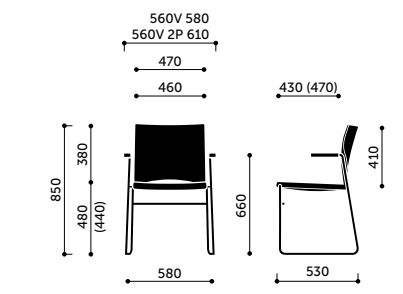
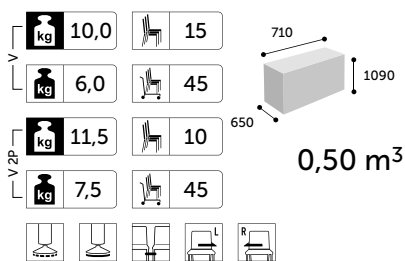

560V / 560V 2P

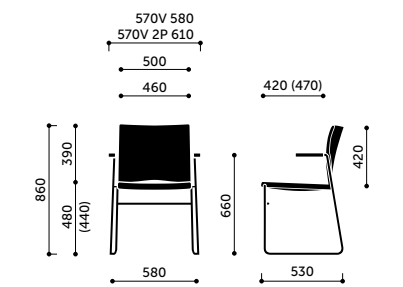
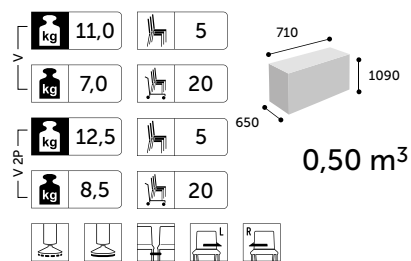

570V / 570V 2P

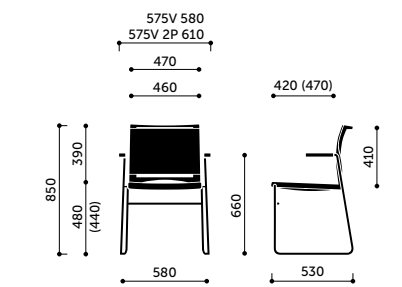
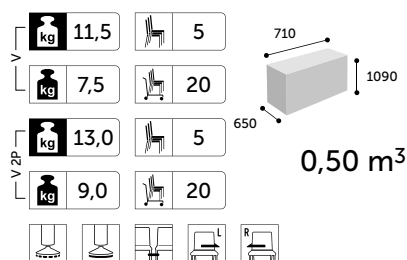

575V / 575V 2P

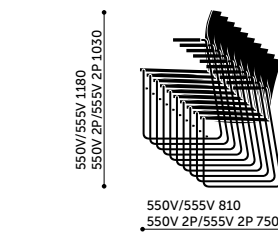
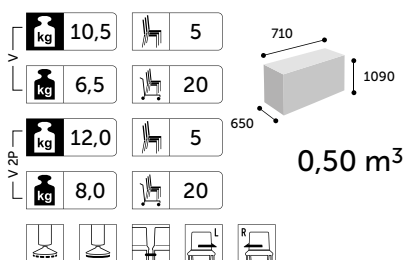

stacking

26% rabatt ska dras av på angivna priser

Technical details

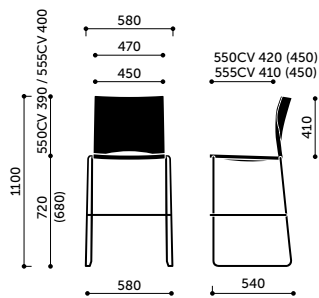

550CV / 555CV

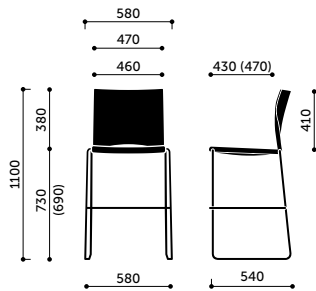

560CV

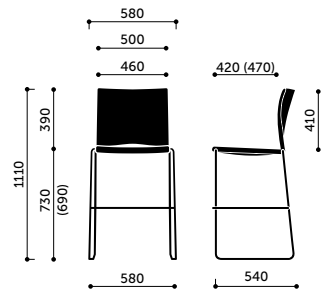

570CV / 575CV

11,0 kg
2
0,44 m³
8,0 kg
10,5 kg
7,5 kg

11,5 kg
2
0,44 m³
8,5 kg

12,0 kg
2
0,44 m³
9,0 kg
11,0 kg
8,0 kg

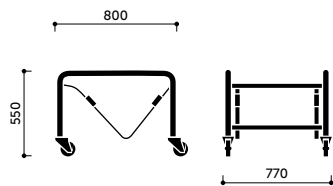

W (chairs trolley)

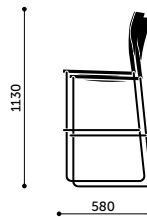

stacking CV

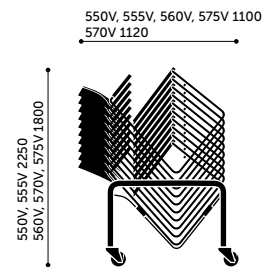

stacking on trolley

16,0 kg
13,0 kg
0,40 m³
820 x **580** x **790**

26% rabatt ska dras av på angivna priser

Technical details

Bit

<p>550H / 550H 2P</p>	<p>555H / 555H 2P</p>	<p>550V / 550V 2P</p>	
<p> </p>	<p> </p>	<p> </p>	
<p>555V / 555V 2P</p>	<p>560H / 560H 2P</p>	<p>560V / 560V 2P</p>	
<p> </p>	<p> </p>	<p> </p>	
<p>570H / 570H 2P</p>	<p>575H / 575H 2P</p>	<p>570V / 570V 2P</p>	<p>stacking H</p>
<p> </p>	<p> </p>	<p> </p>	

26% rabatt ska dras av på angivna priser

Technical details

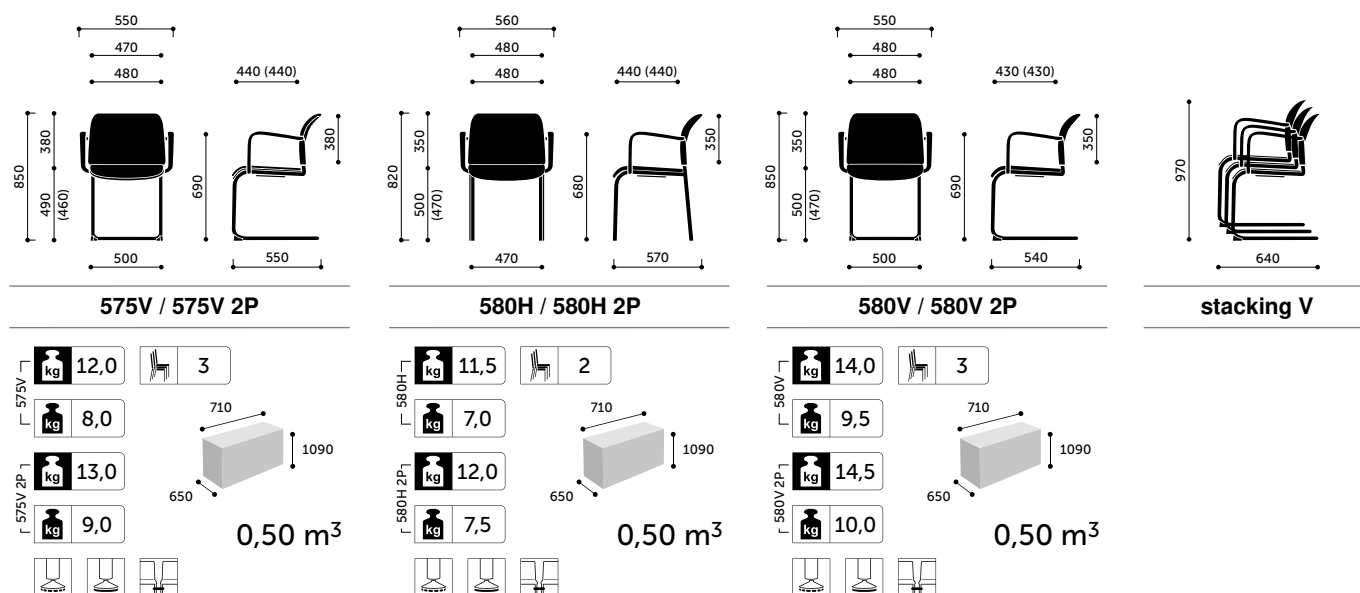

Chic

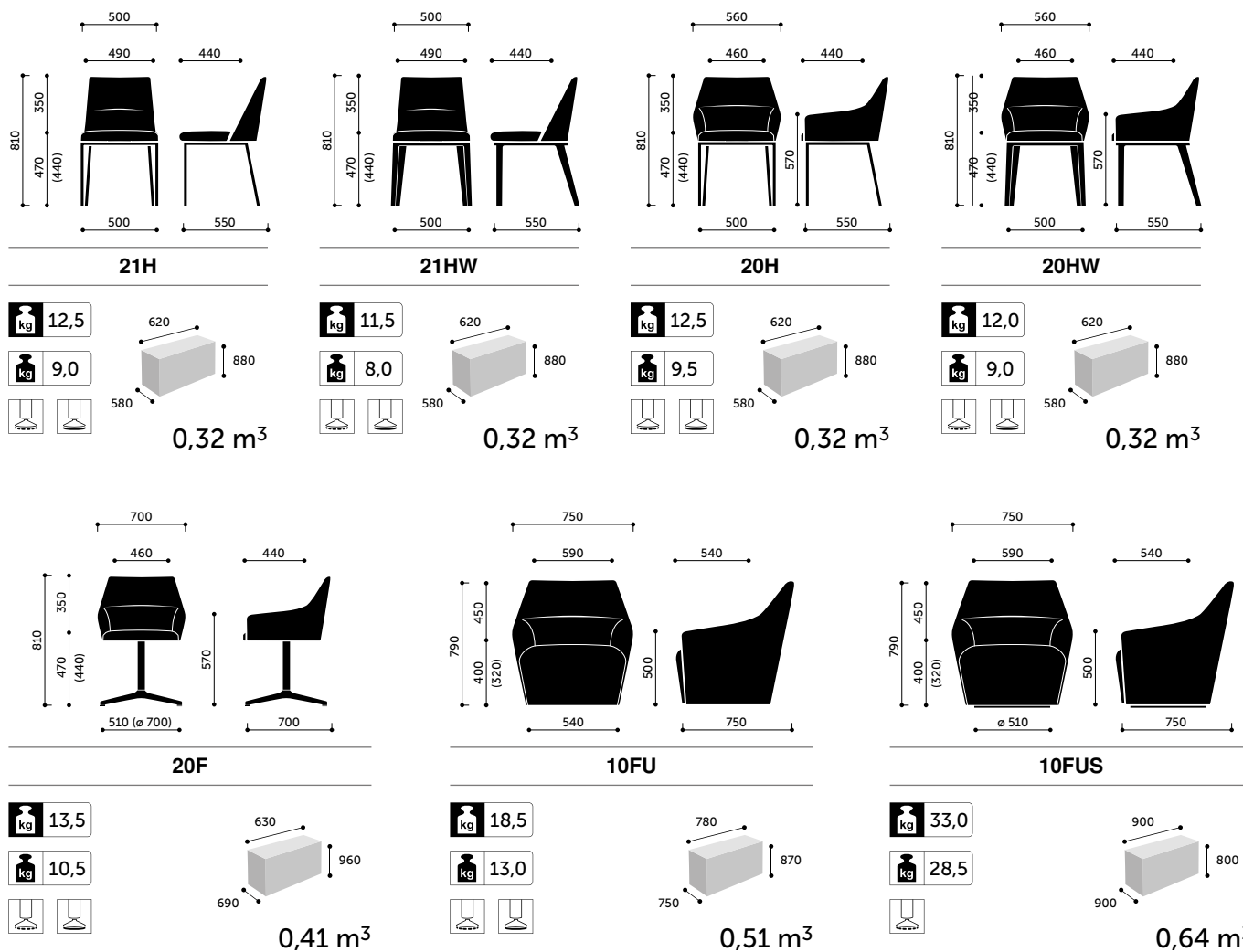

26% rabatt ska dras av på angivna priser

Technical details

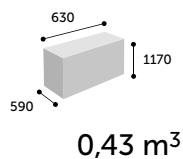
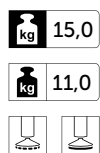
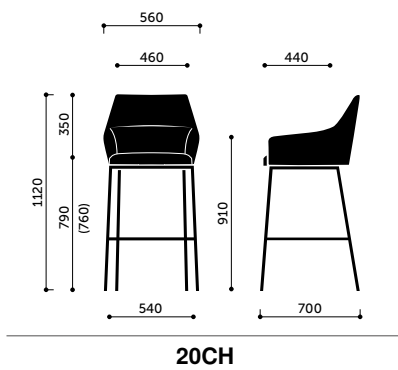
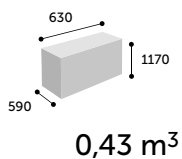
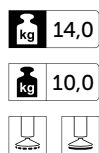
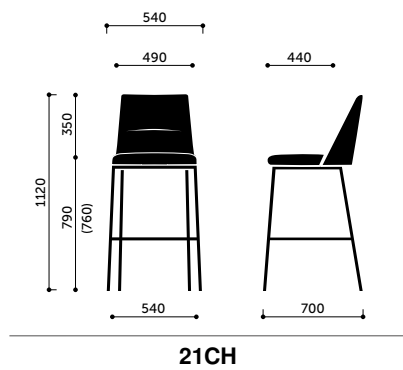

Chic Lounge

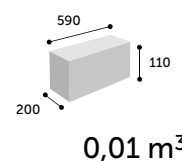
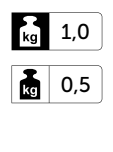
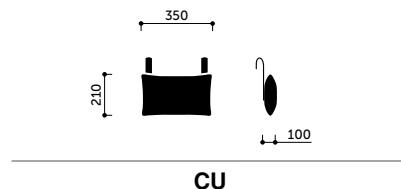
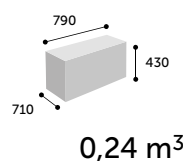
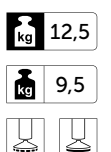
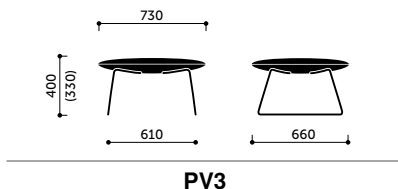
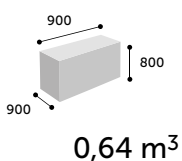
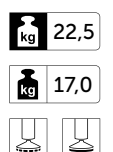
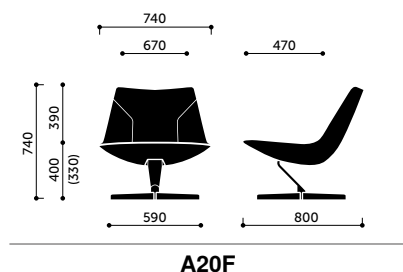
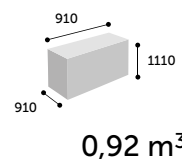
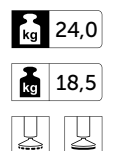
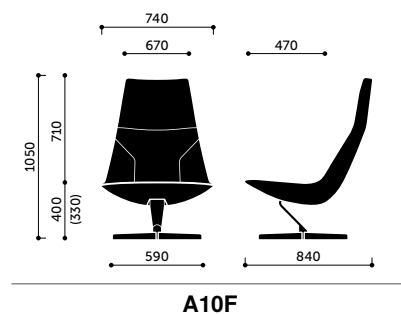
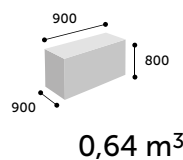
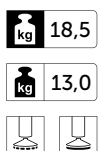
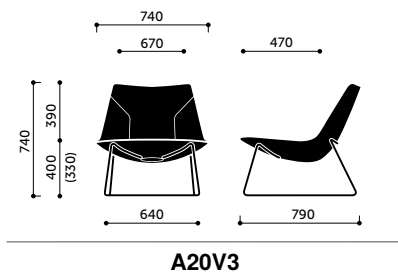
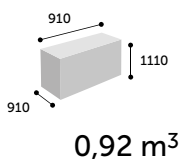
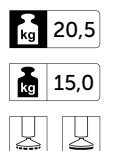
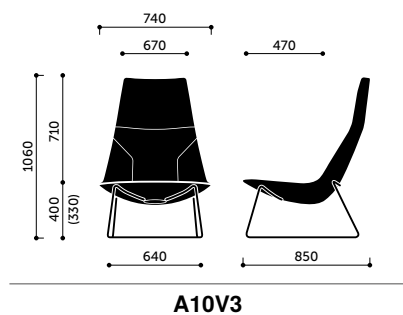

26% rabatt ska dras av på angivna priser

Technical details

Chic Tables

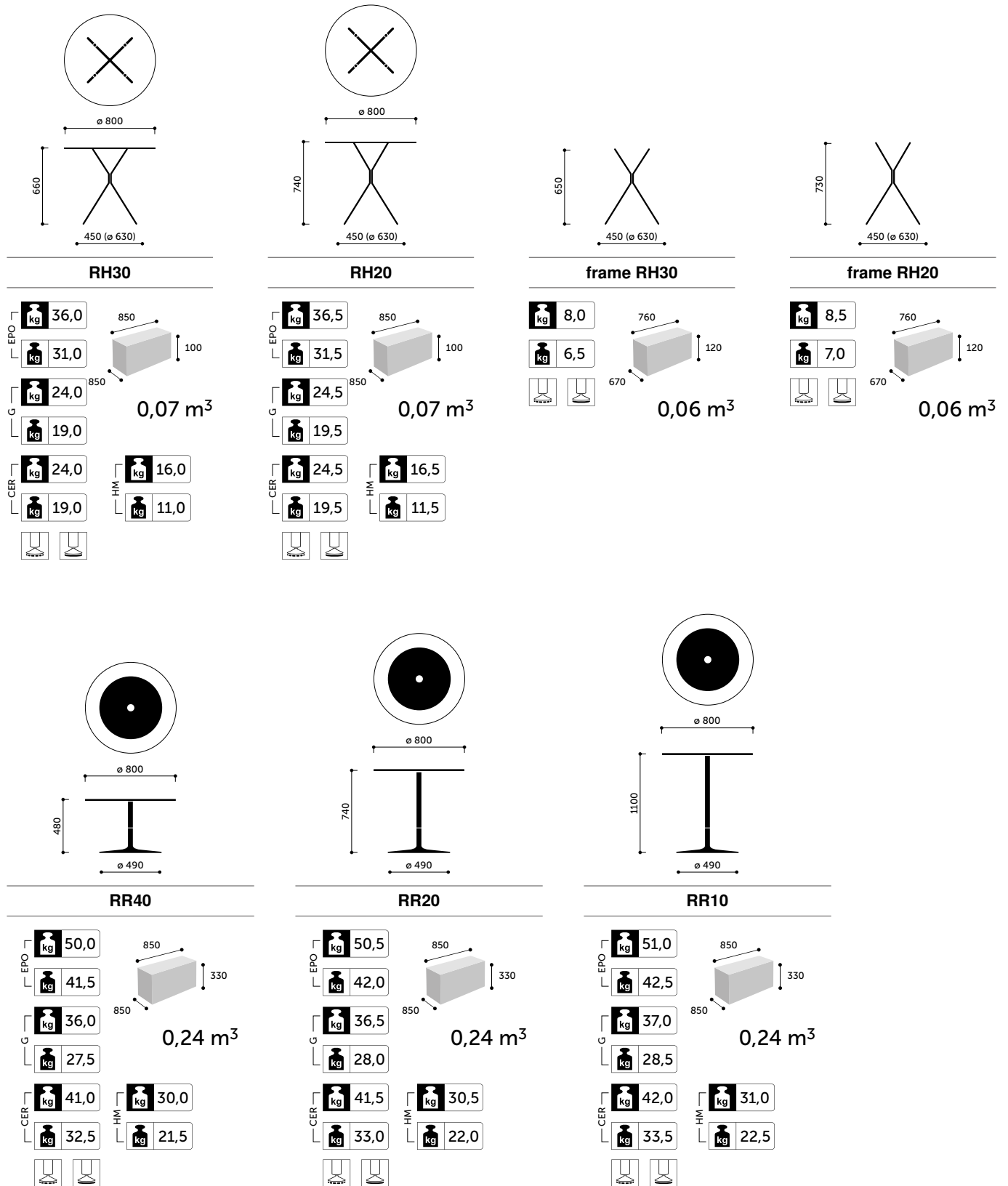

26% rabatt ska dras av på angivna priser

Technical details

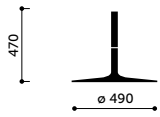

frame RR40

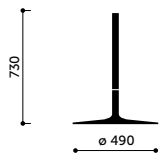
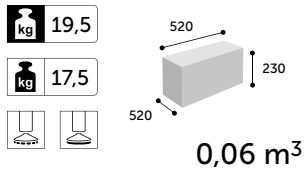

frame RR20

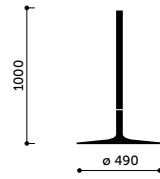
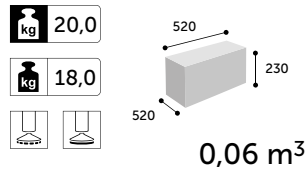

frame RR10

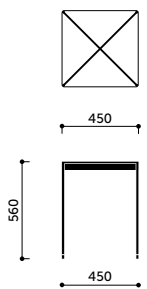
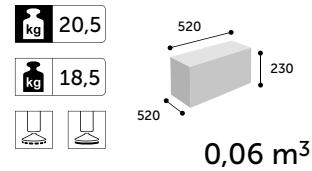

CS30

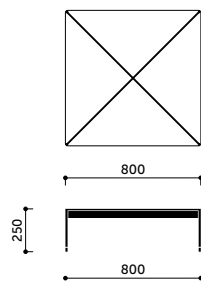
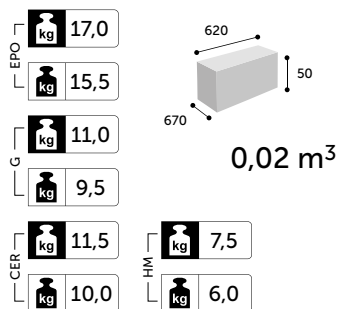

CS40

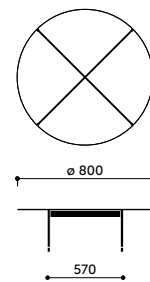
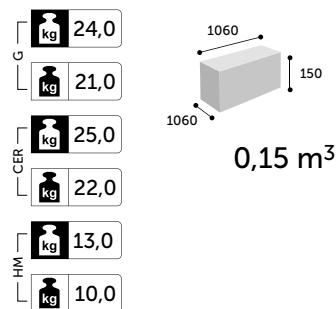

CR40

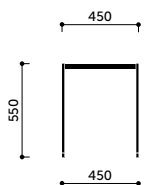
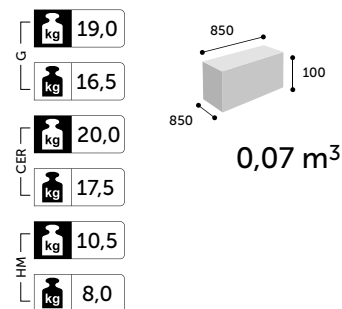

frame CS30

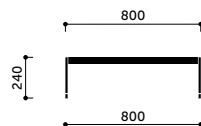
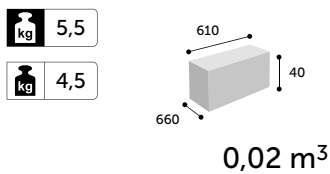

frame CS40

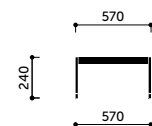
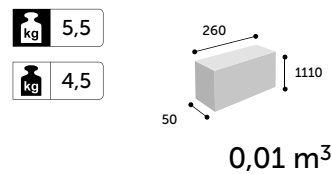

frame CR40

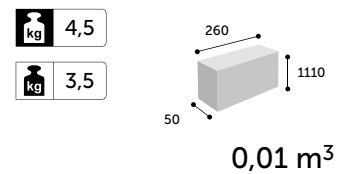

26% rabatt ska dras av på angivna priser

Technical details

Com

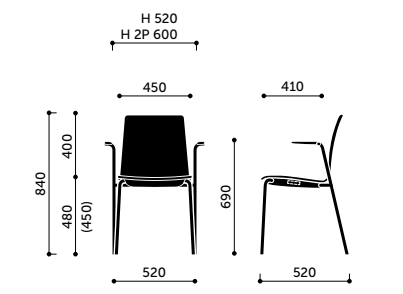

K12H / K12H 2P

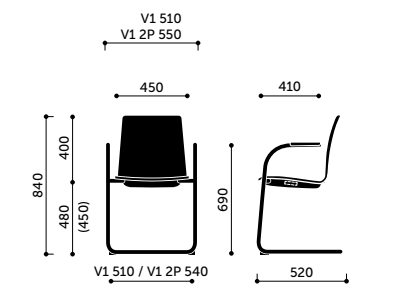
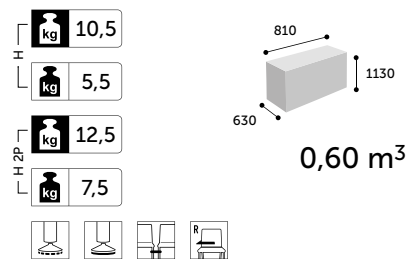

K12V1 / K12V1 2P

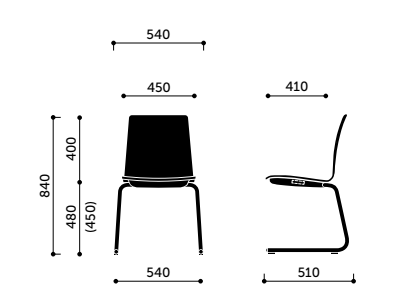
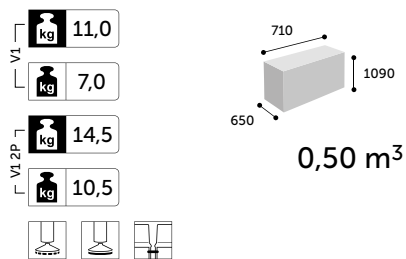

K12V2

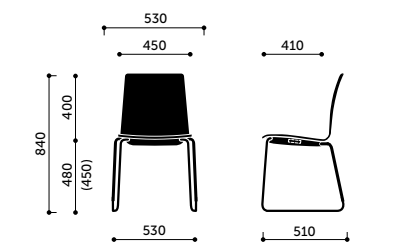
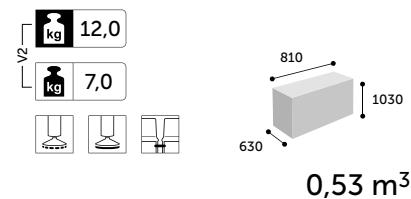

K12V

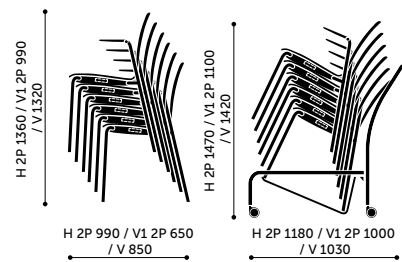
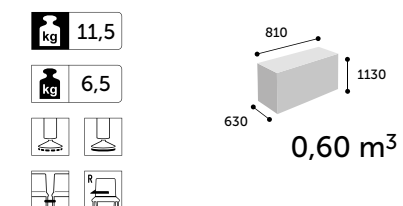

stacking K12

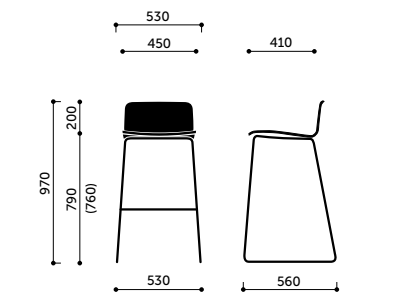
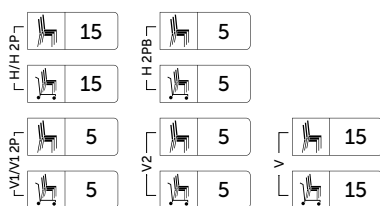

K12CV

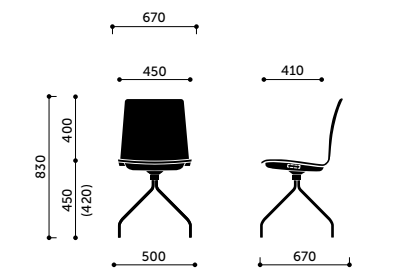
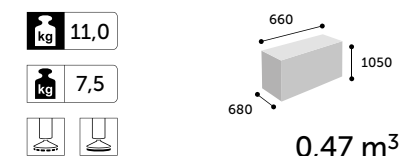

K12HF/HS

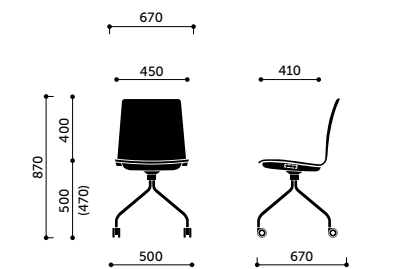
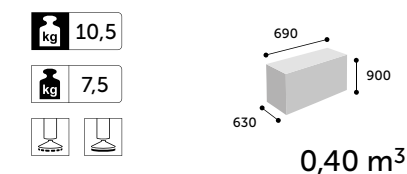

K12HC

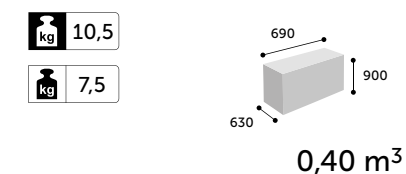

26% rabatt ska dras av på angivna priser

Technical details

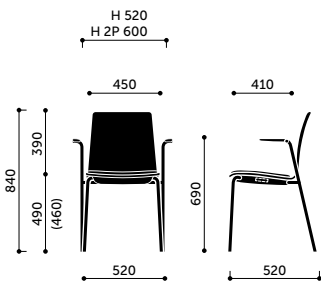

K22H / K22H 2P

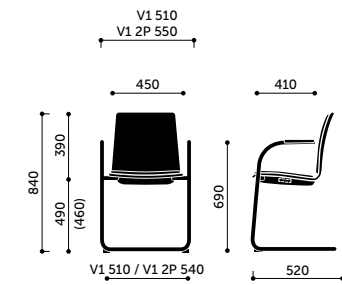
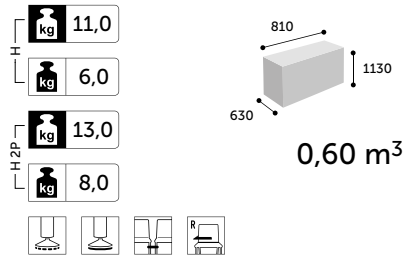

K22V1 / K22V1 2P

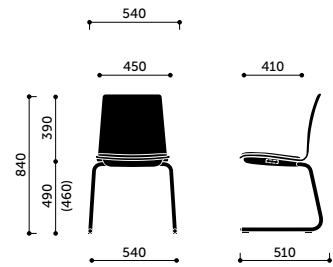
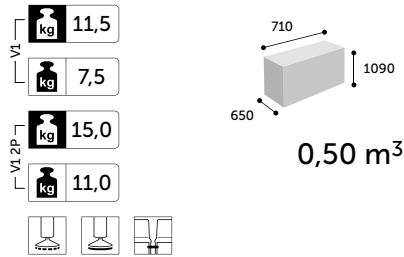

K22V2

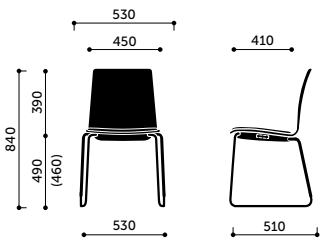
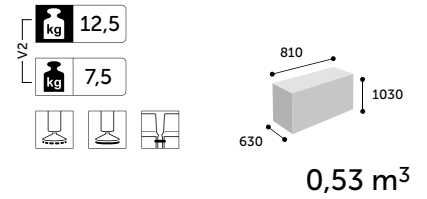

K22V

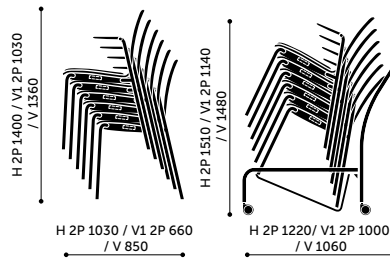
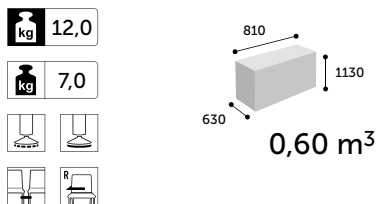

stacking K22

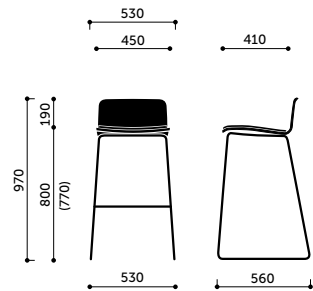
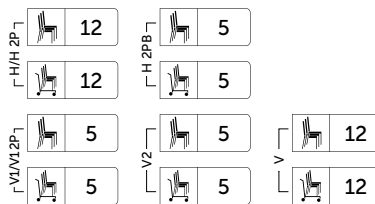

K22CV

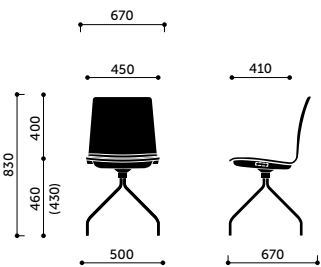
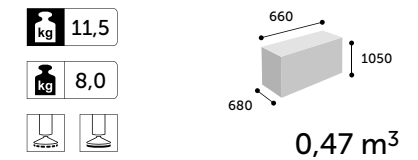

K22HF/HS

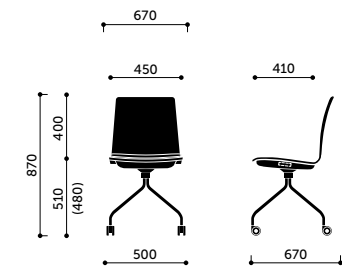
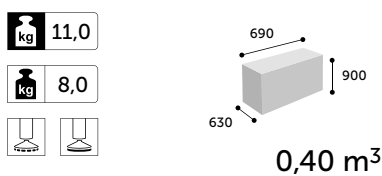

K22HC

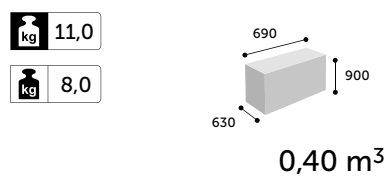

26% rabatt ska dras av på angivna priser

Technical details

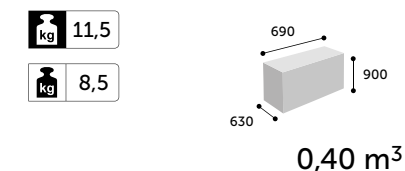
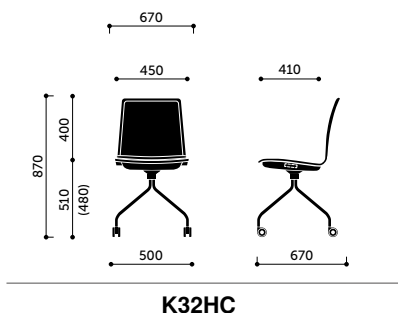
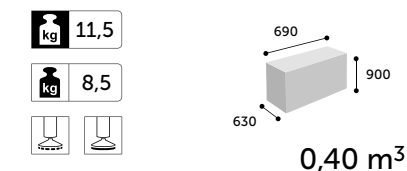
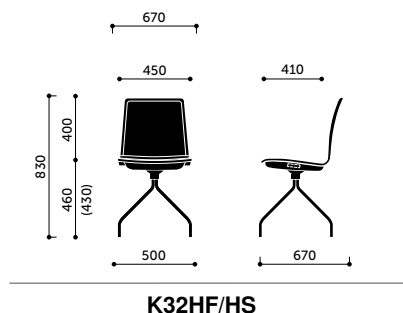
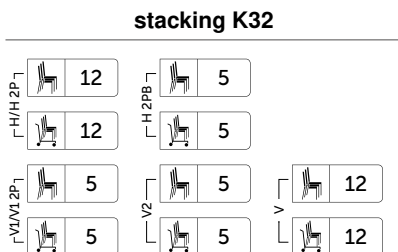
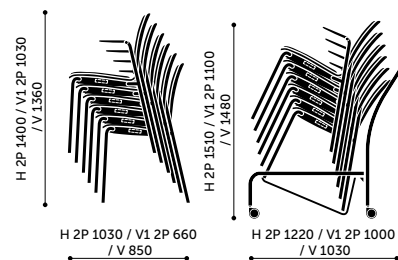
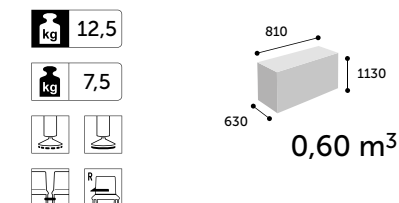
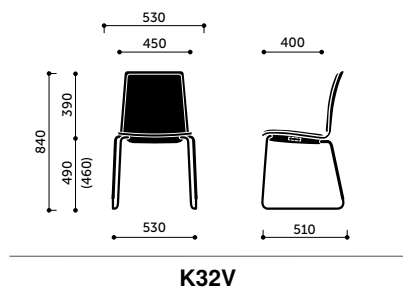
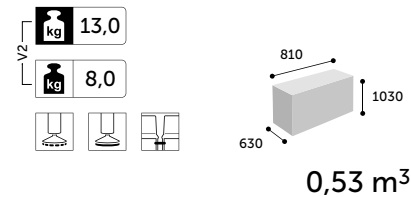
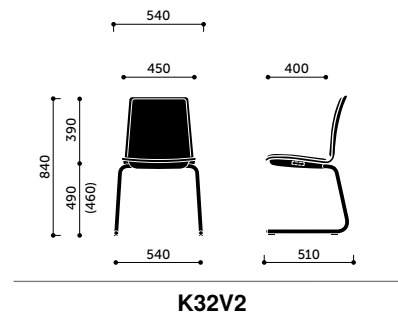
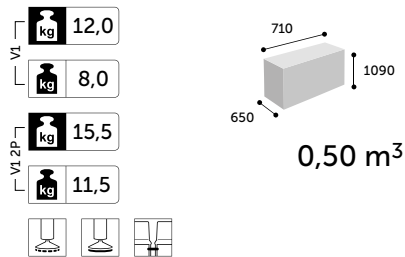
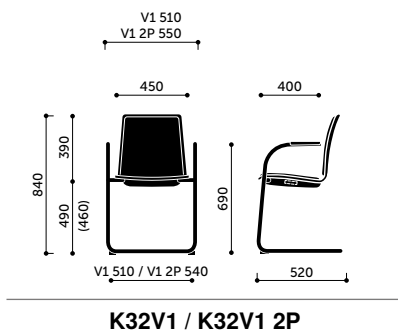
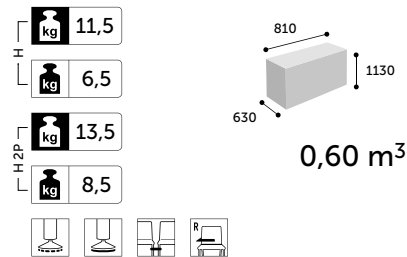
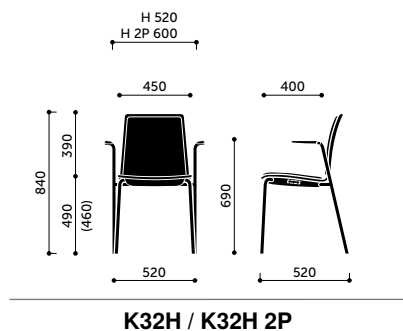

26% rabatt ska dras av på angivna priser

Technical details

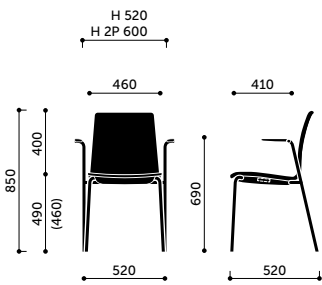

K42H / K42H 2P

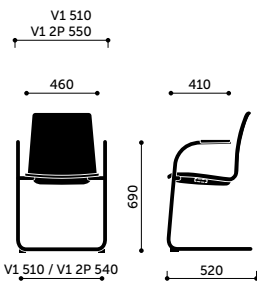
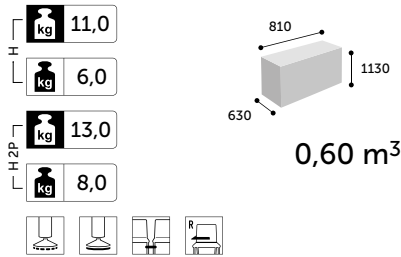

K42V1 / K42V1 2P

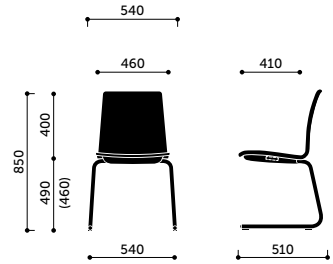
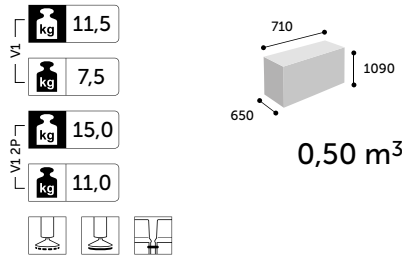

K42V2

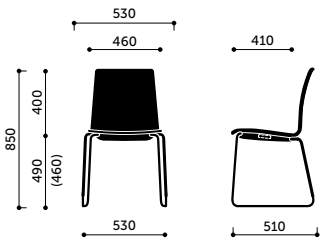
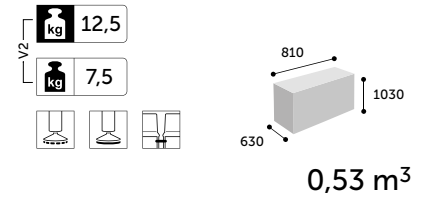

K42V

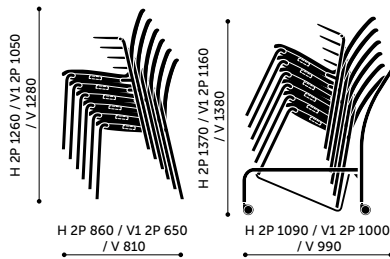
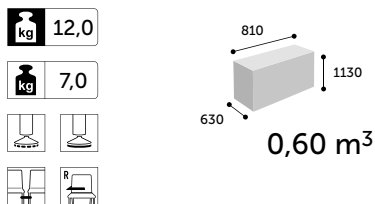

stacking K42

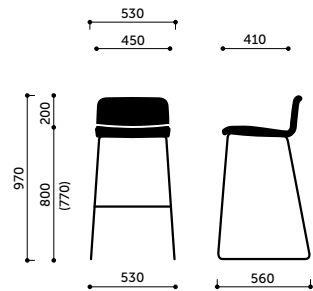
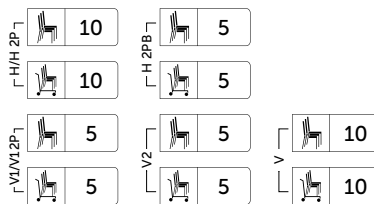

K42CV

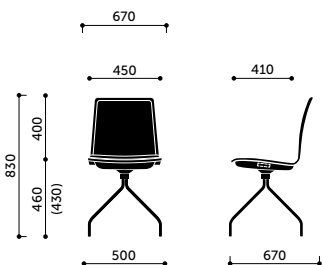
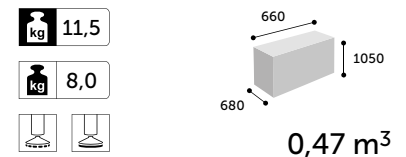

K32HF/HS

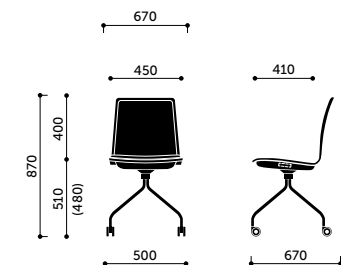
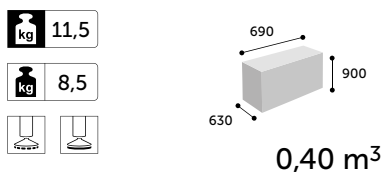

K32HC

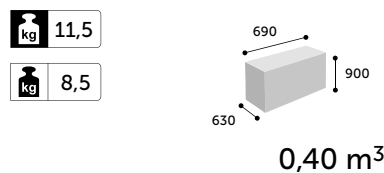

26% rabatt ska dras av på angivna priser

Technical details

Ellie^{Pro}

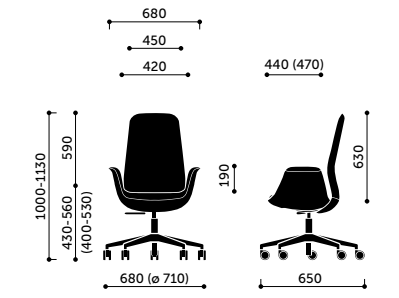

10ST

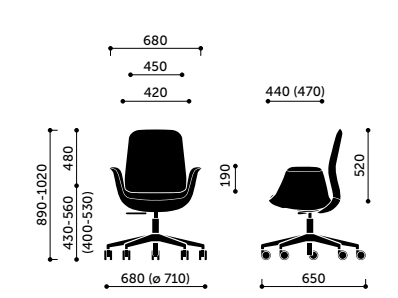
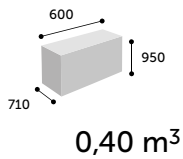
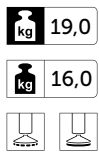

20ST

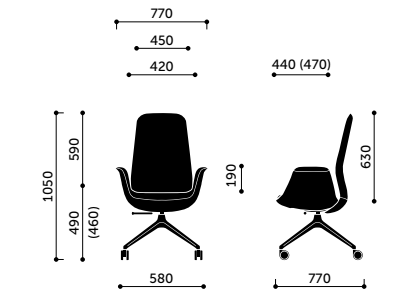
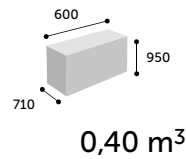
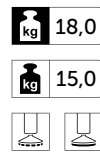

10HST

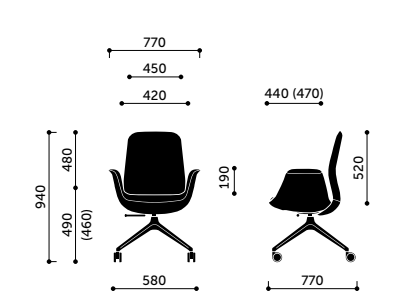
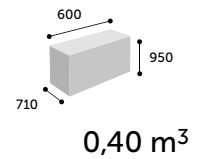
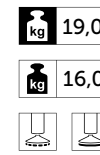

20HST

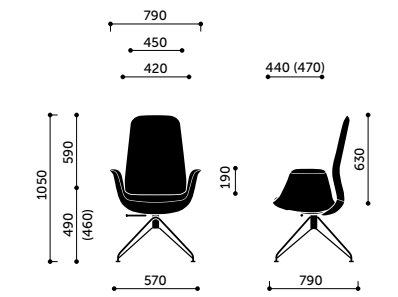
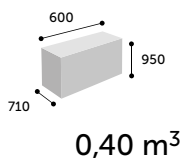
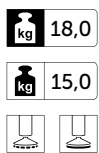

10V3

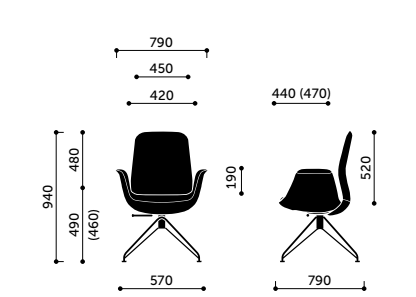
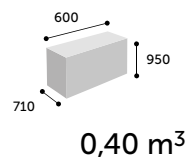
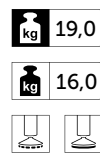

20V3

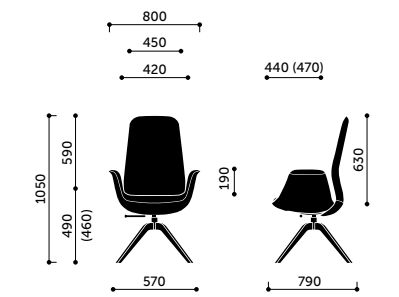
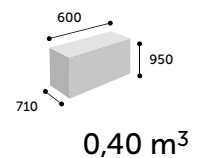
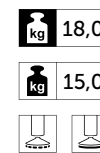

10HW

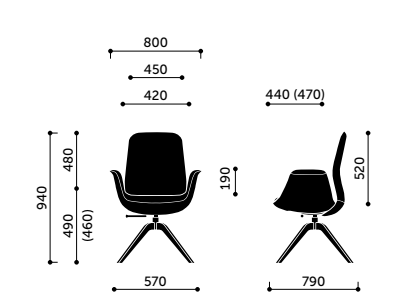
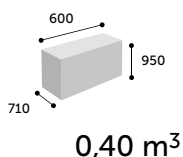
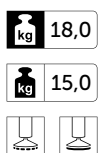

20HW

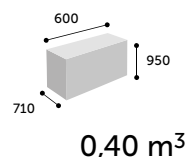
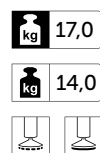

26% rabatt ska dras av på angivna priser

Technical details

Eminent

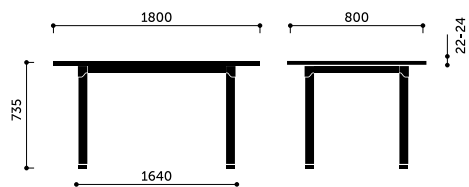

Eminent 4590-22

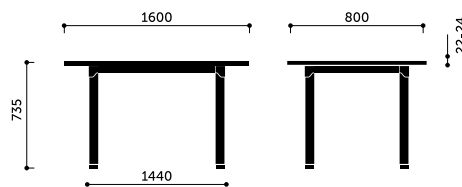

Eminent 4590-24

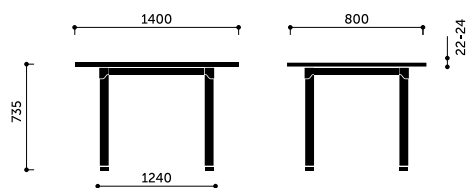

Eminent 4590-25



Eminent 4590-38

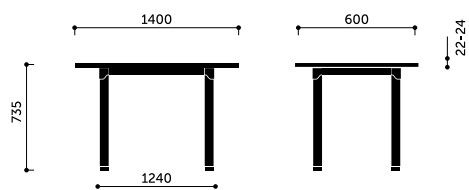

Eminent 4590-52

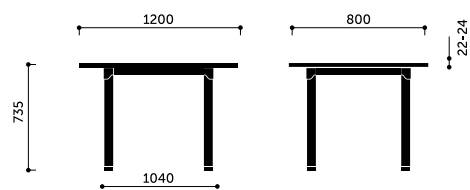

Eminent 4590-27

26% rabatt ska dras av på angivna priser

Technical details

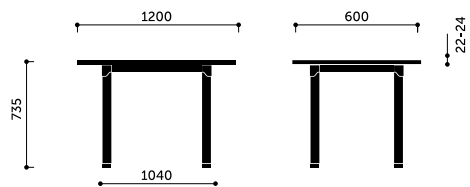

Eminent 4590-54

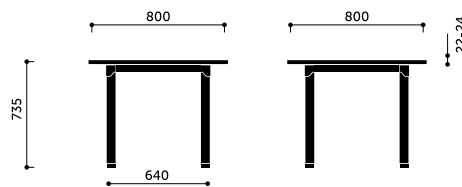

Eminent 4590-30

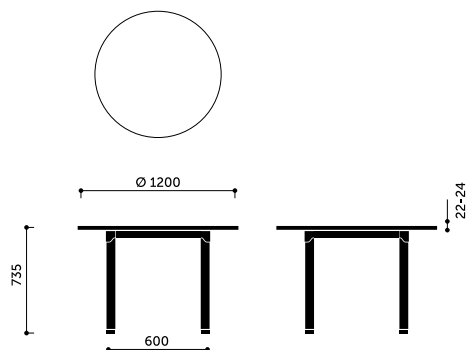

Eminent 4592-30

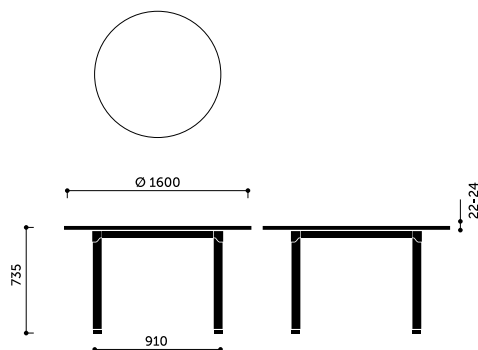

Eminent 4592-50

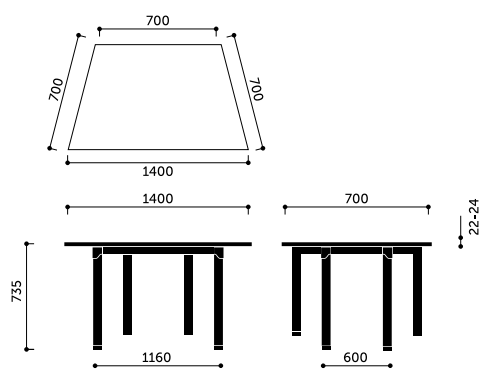

Eminent 4592-50

26% rabatt ska dras av på angivna priser

Technical details

Fan

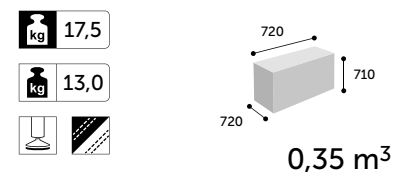
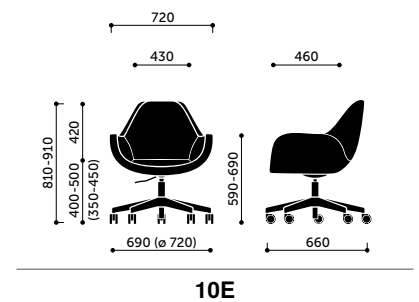
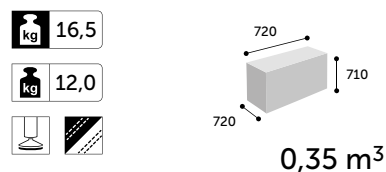
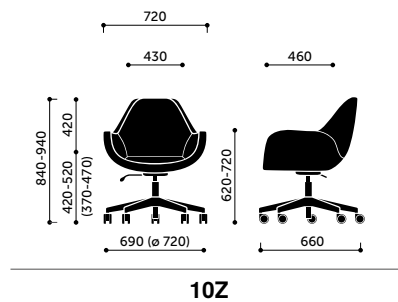
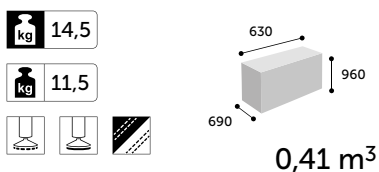
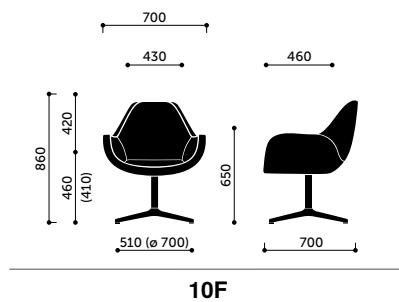
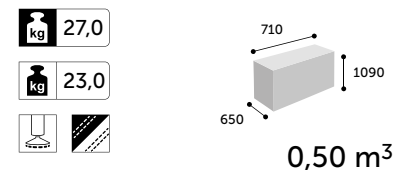
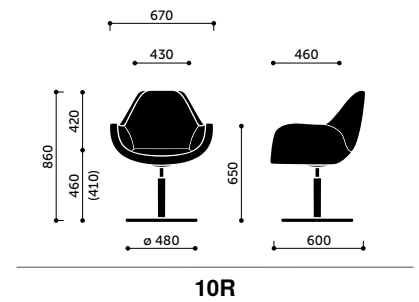
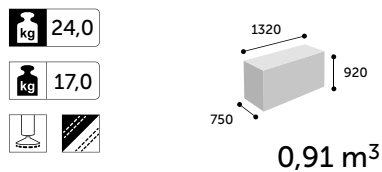
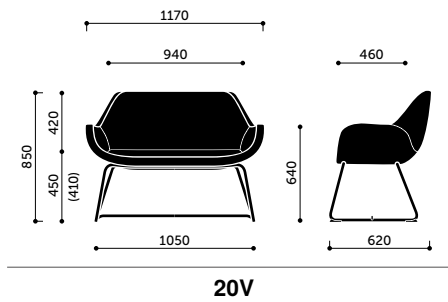
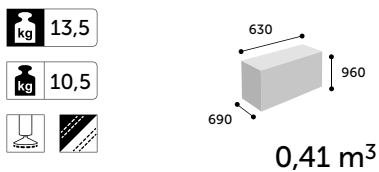
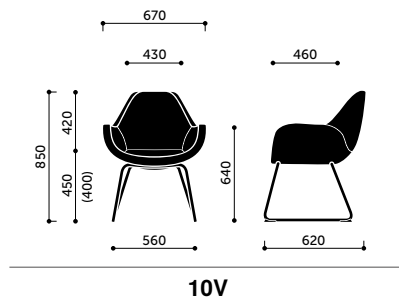
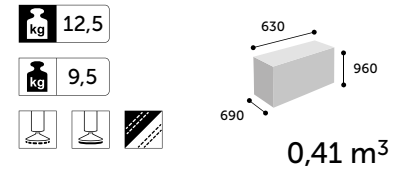
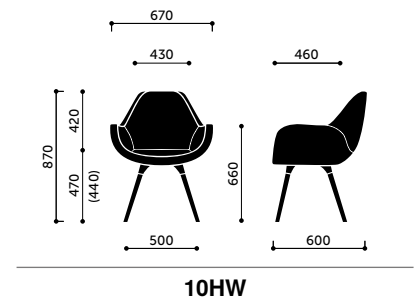
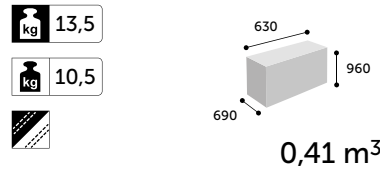
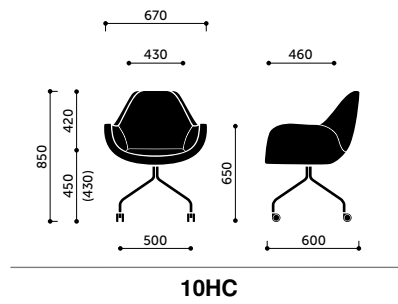
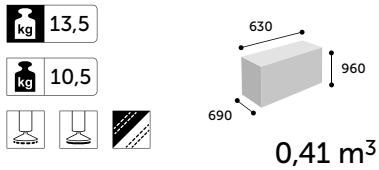
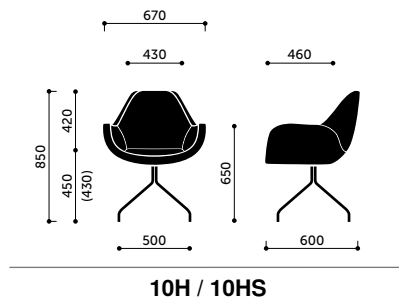

Mickey

26% rabatt ska dras av på angivna priser

Technical details

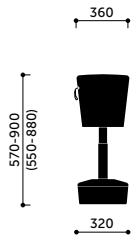

Mickey

kg 13,5

kg 11,5

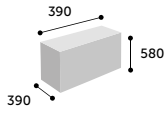

0,09 m³

MyTurn Sofa

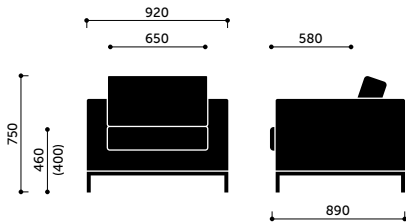

10H / 10V

kg 40,0

kg 35,0

kg 45,5

kg 40,5

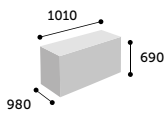

0,68 m³

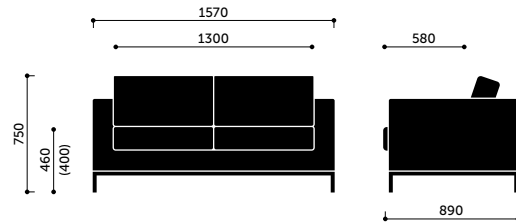

20H / 20V

kg 60,5

kg 54,0

kg 61,5

kg 55,0

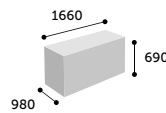

1,12 m³



30H / 30V

kg 76,0

kg 67,5

kg 77,0

kg 68,5

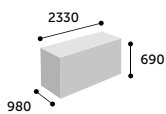

1,58 m³

26% rabatt ska dras av på angivna priser

Technical details

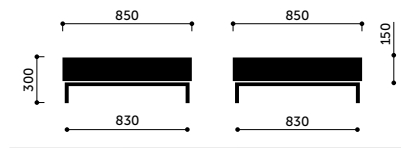

S2H

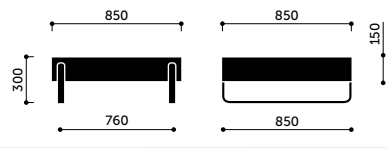

S2V

kg 37,0
kg 33,5

920
 920
 430
0,36 m³

kg 42,0
kg 38,5

920
 920
 430
0,36 m³

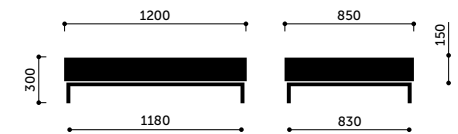

S1H

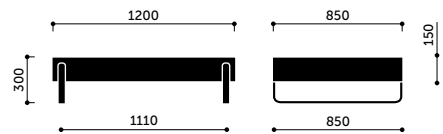

S1V

kg 53,0
kg 49,0

1260
 860
 520
0,60 m³

kg 53,5
kg 49,5

1260
 860
 520
0,60 m³

Noor

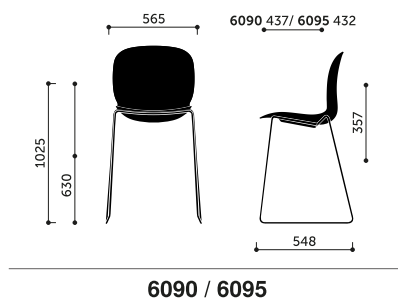
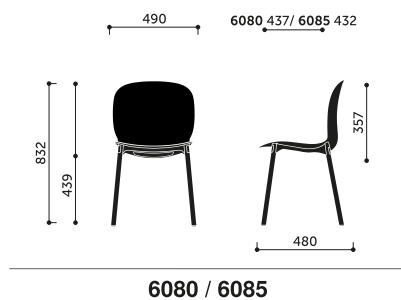
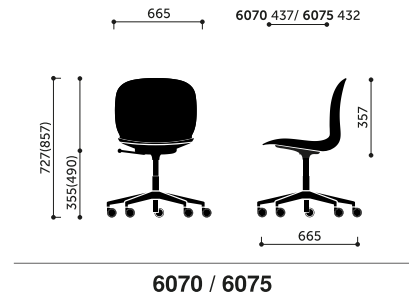
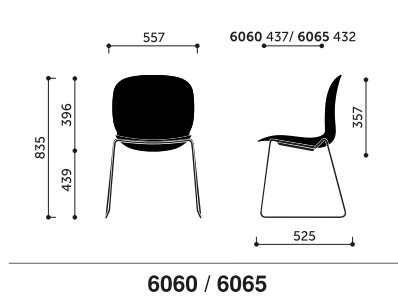
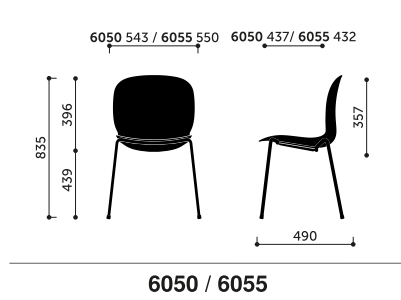

26% rabatt ska dras av på angivna priser

Technical details

Normo

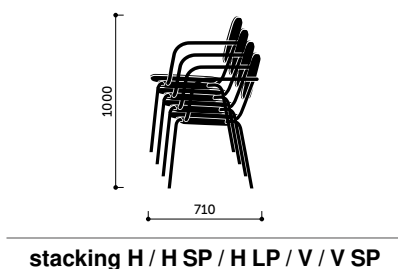
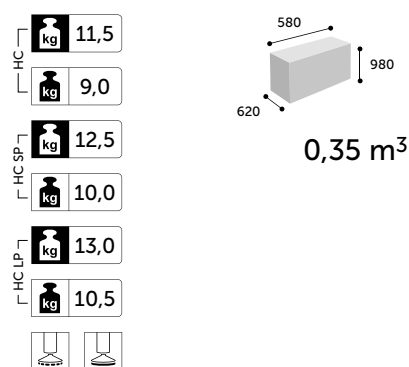
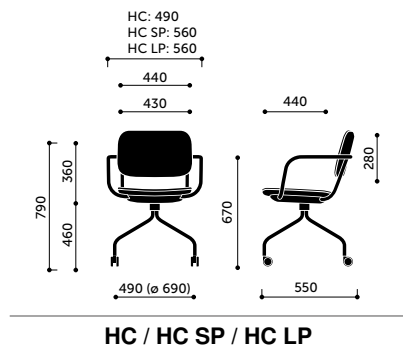
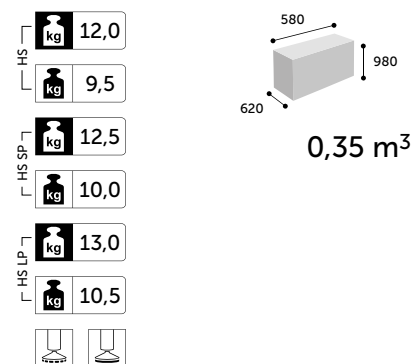
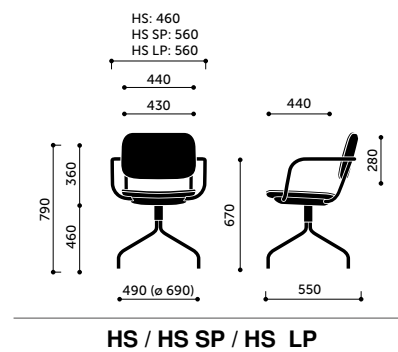
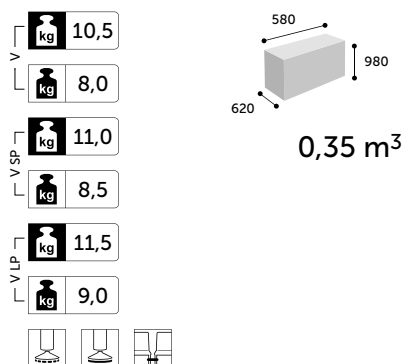
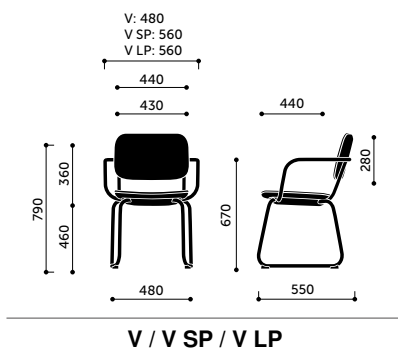
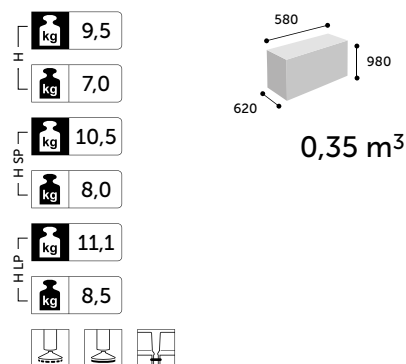
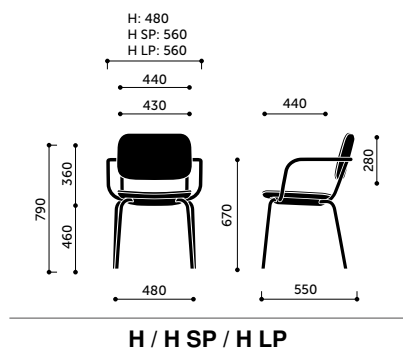

26% rabatt ska dras av på angivna priser

Technical details

Nu

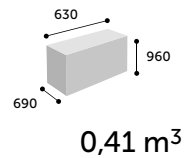
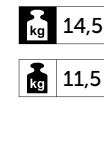
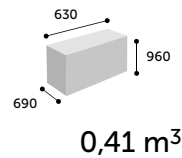
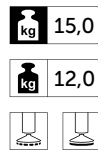
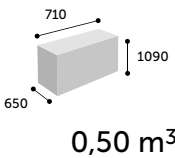
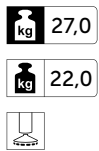
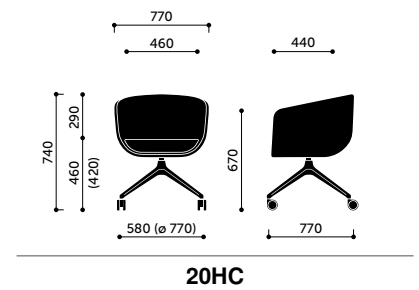
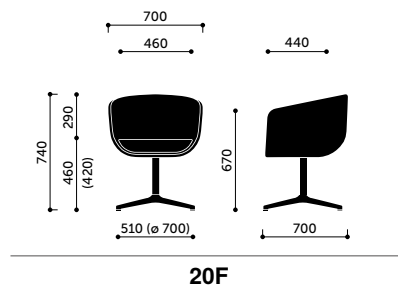
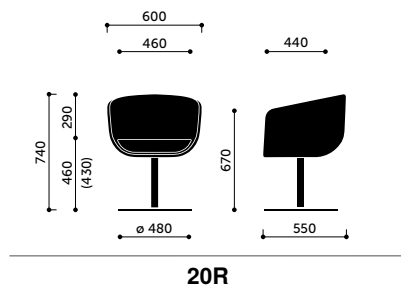
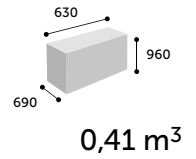
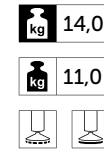
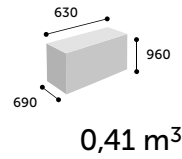
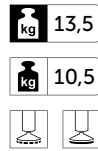
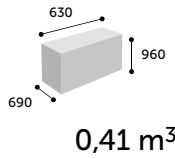
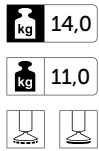
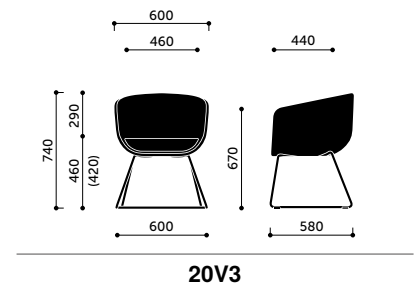
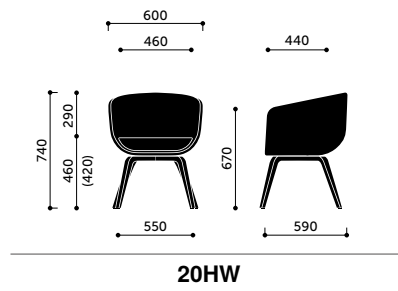
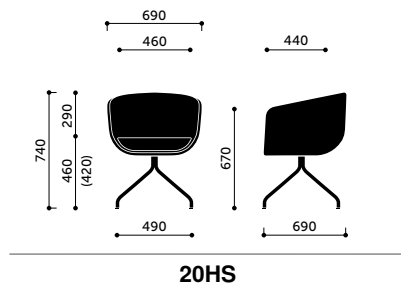

October

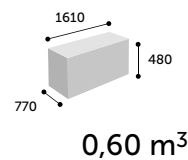
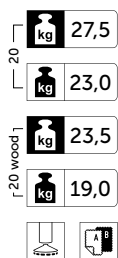
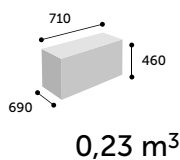
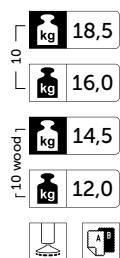
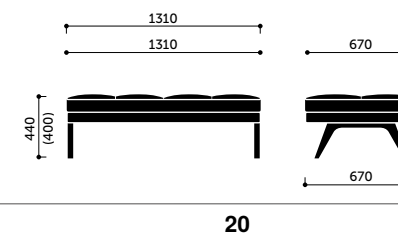
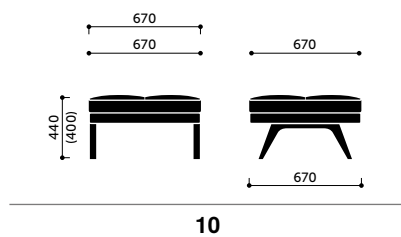

26% rabatt ska dras av på angivna priser

Technical details

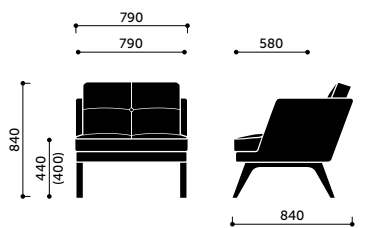

11

11	kg 38,5	900	800	900	0,64 m ³
	kg 34,0				
11 wood	kg 34,5				
	kg 30,0				

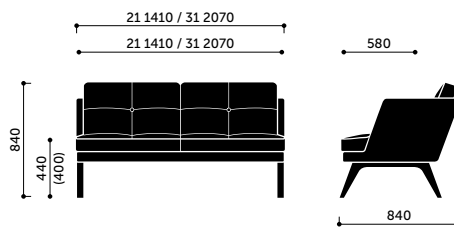

21 / 31

21	kg 49,5	1750	810	960	1,40 m ³
	kg 42,0				
31	kg 64,5	2330	690	980	1,58 m ³
	kg 56,0				
21 wood	kg 45,5				
	kg 38,0				
31 wood	kg 60,5				
	kg 52,0				

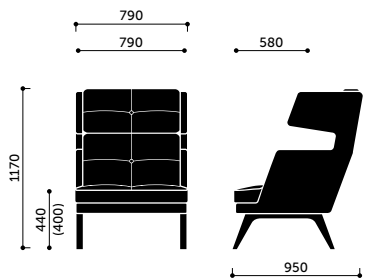

12

12	kg 49,0	970	1210	980	1,15 m ³
	kg 41,0				
12 wood	kg 45,0				
	kg 37,0				

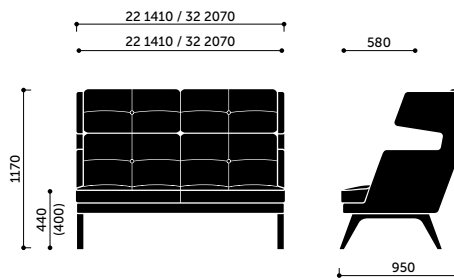

22 / 32

22	kg 70,5	1620	1210	980	1,90 m ³
	kg 59,0				
32	kg 89,0	2300	1210	980	2,70 m ³
	kg 77,5				
22 wood	kg 66,5				
	kg 55,0				
32 wood	kg 85,0				
	kg 73,5				

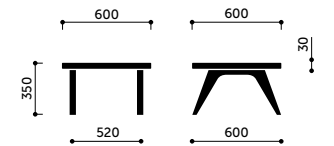

S2

S2	kg 15,0	610	360	610	0,13 m ³
	kg 13,0				
S2 wood	kg 11,0				
	kg 9,0				

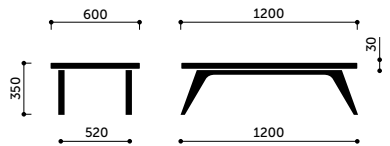

S1

S1	kg 27,5	1250	400	650	0,33 m ³
	kg 24,5				
S1 wood	kg 21,5				
	kg 18,5				

26% rabatt ska dras av på angivna priser

Technical details

Revo

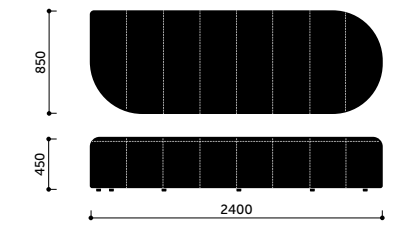

SW240

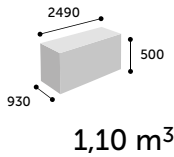
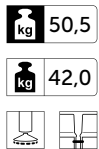

1,10 m³

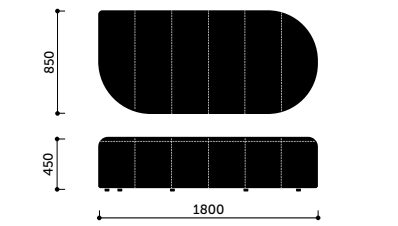

SW180

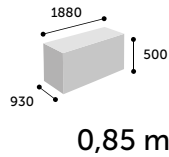
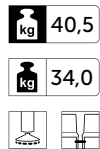

0,85 m³

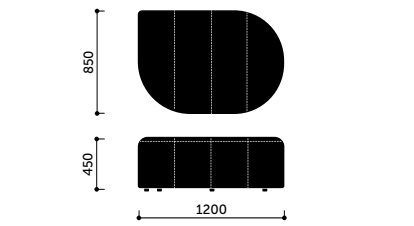

SW120

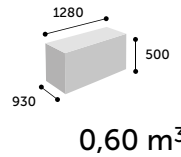

0,60 m³

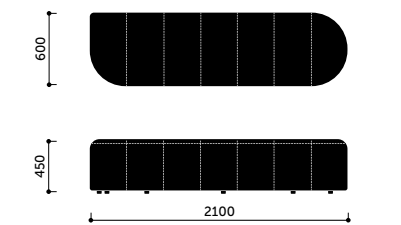

SN210

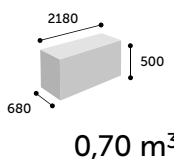
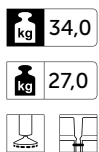

0,70 m³

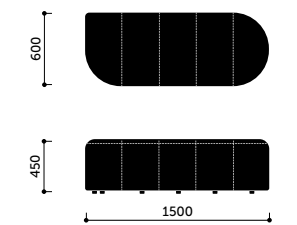

SN150

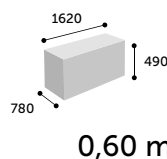
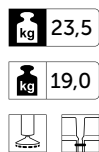

0,60 m³

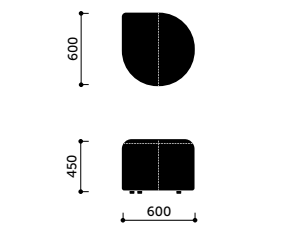

P60

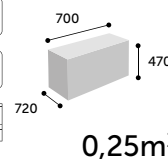
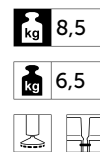

0,25m³

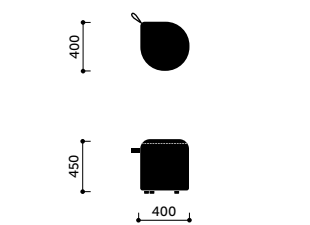

P40

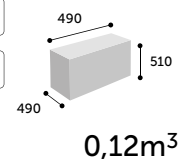
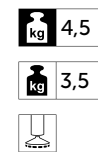

0,12m³

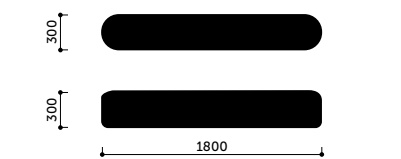

B180

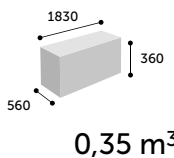

0,35 m³

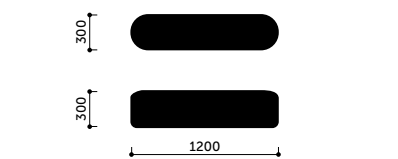

B120

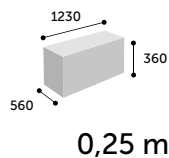
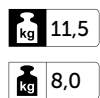

0,25 m³

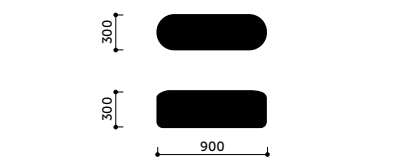

B90

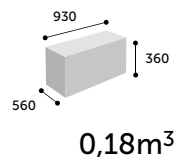
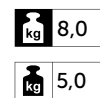

0,18m³

26% rabatt ska dras av på angivna priser

Technical details

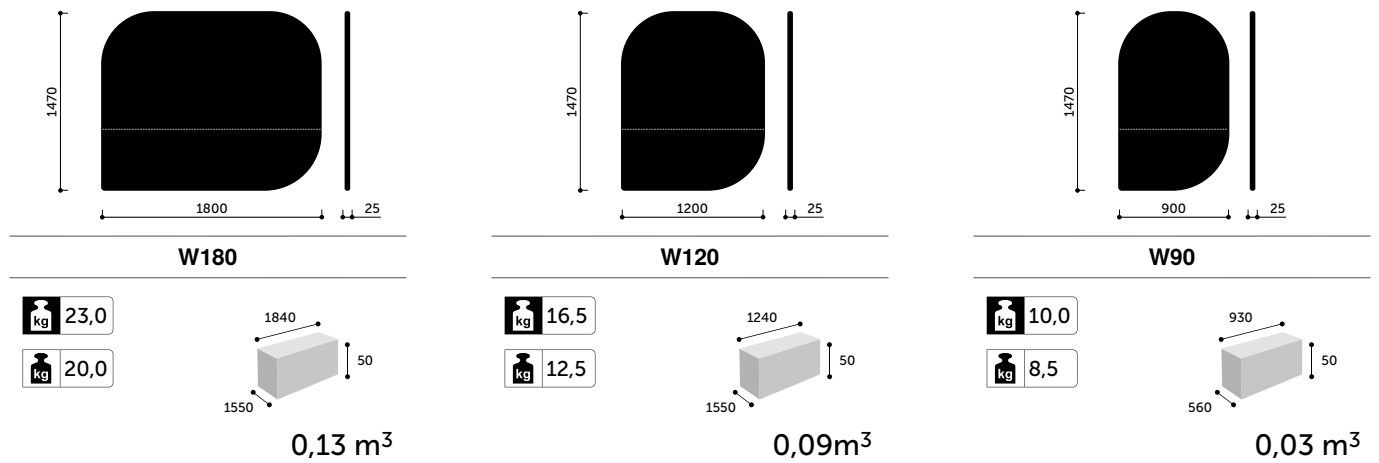

Revo Tables

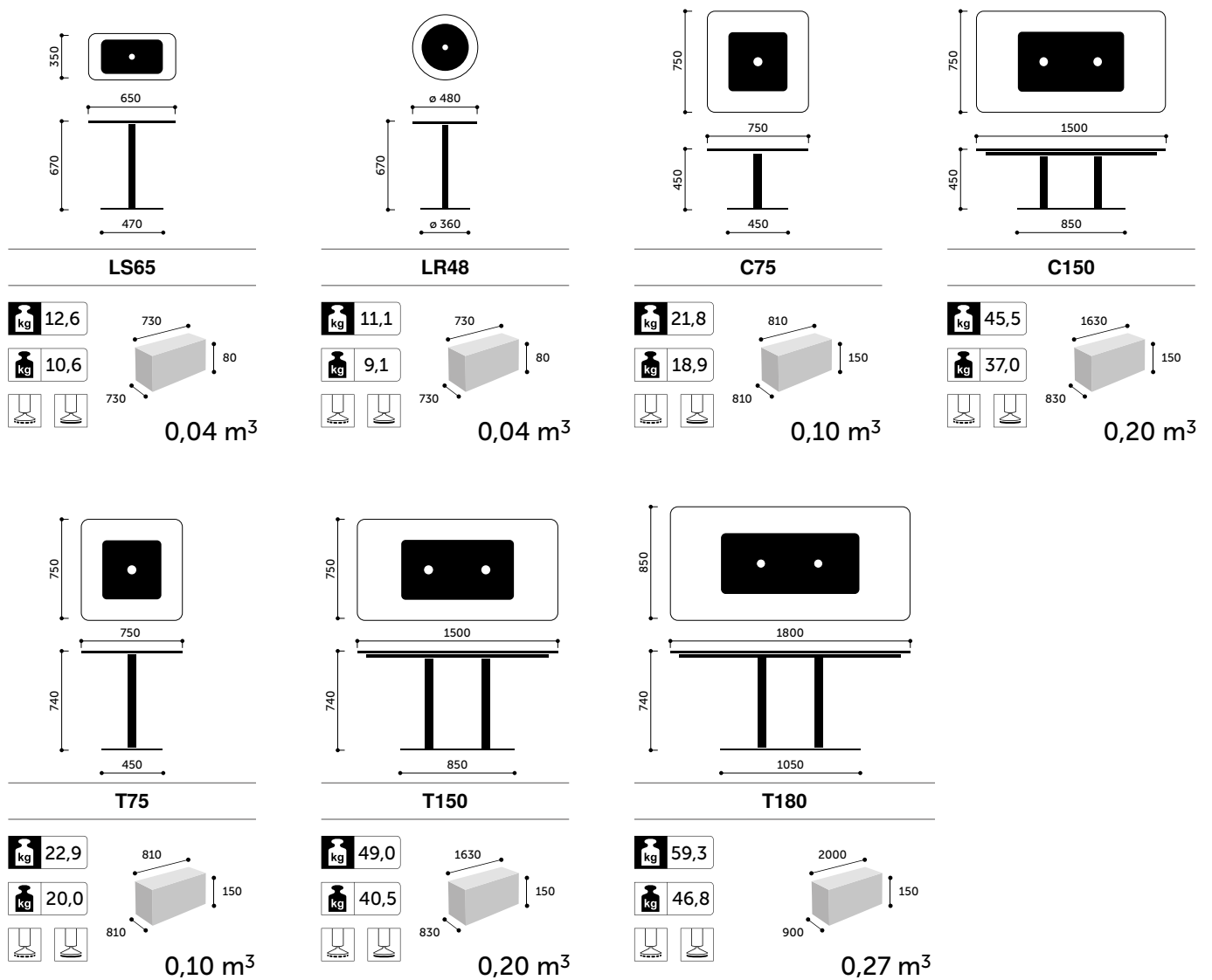

26% rabatt ska dras av på angivna priser

Technical details

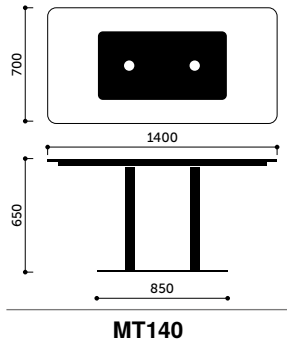

MT140

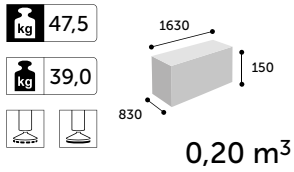

Seven

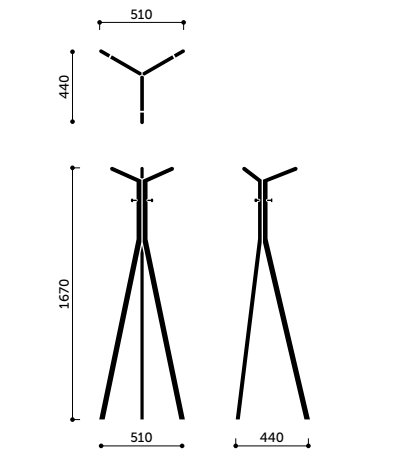

Seven

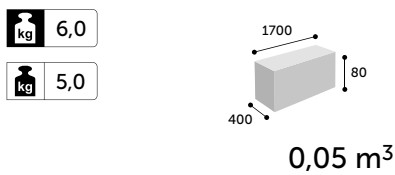

SoftBox

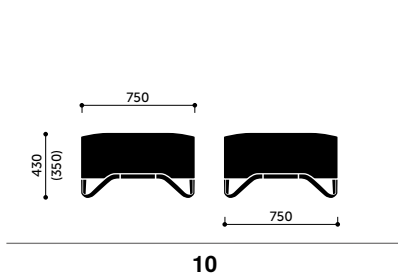

10

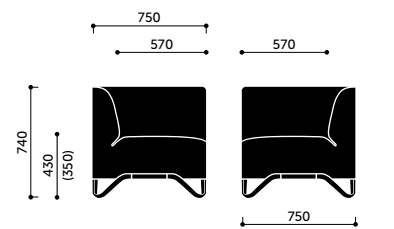
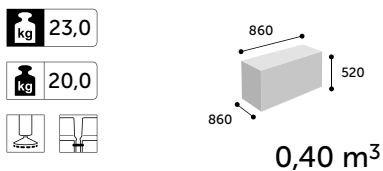

1C

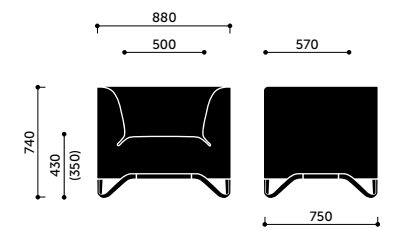
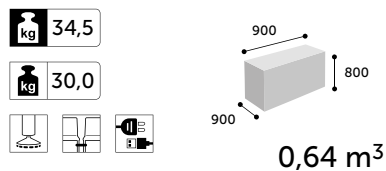

11

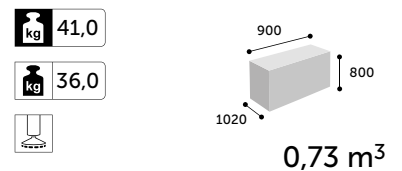

26% rabatt ska dras av på angivna priser

Technical details

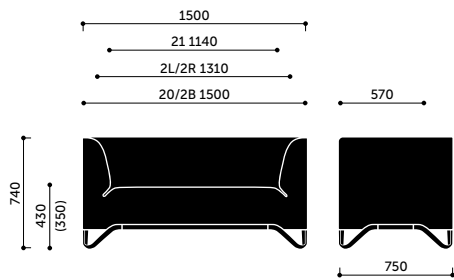

20 / 2B / 2L / 2R / 21

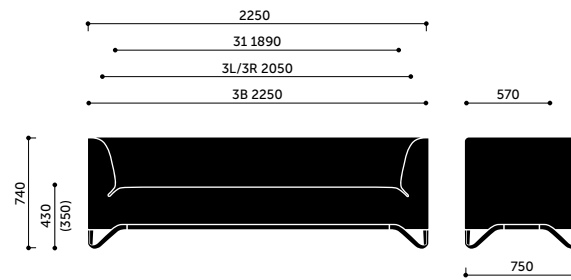

3B / 3L / 3R / 31

20	33,5 kg		<p>0,74 m³</p>
	29,0 kg		
2B	55,0 kg		<p>1,20 m³</p>
	48,0 kg		
2L/2R	58,0 kg		
	51,0 kg		
21	61,0 kg		
	54,0 kg		

3B	79,0 kg		<p>1,75 m³</p>
	70,0 kg		
3L/3R	82,0 kg		
	73,0 kg		
31	85,0 kg		
	76,0 kg		

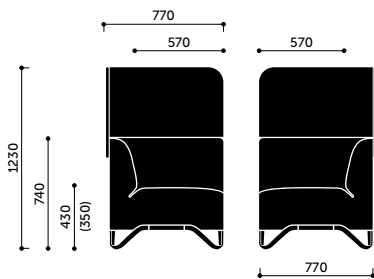

1CW

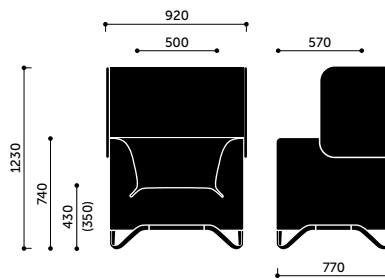

11W

42,5 kg	<p>0,64 m³</p>
38,0 kg	

52,0 kg	<p>0,73 m³</p>
47,0 kg	

26% rabatt ska dras av på angivna priser

Technical details

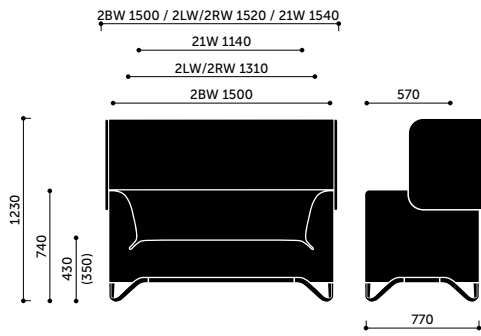

2BW / 2LW / 2RW / 21W

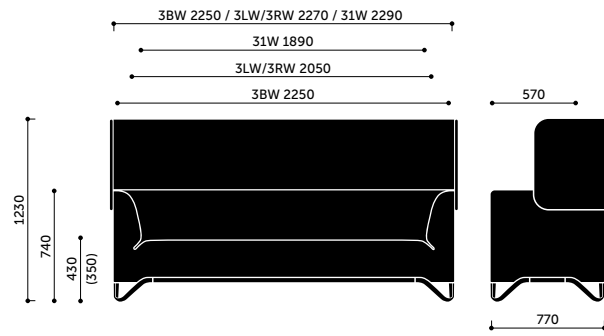

3BW / 3LW / 3RW / 31W

2BW	63,5			1650	800	900	1,20 m³
	56,5						
2LW/2RW	68,5			2400	800	900	1,75 m³
	61,5						
21W	75,5						
	68,5						

3BW	92,5			1650	800	900	1,20 m³
	83,5						
3LW/3RW	98,0			2400	800	900	1,75 m³
	89,0						
31W	102,5						
	93,5						

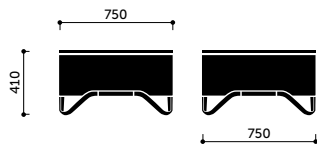

S2

27,0		860	520	860	0,40 m³
24,0					

Sorriso

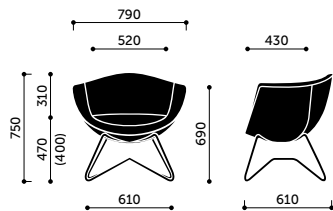

10V

17,5		810	1030	630	0,53 m³
13,5					

26% rabatt ska dras av på angivna priser

Technical details

Standard Folding Table

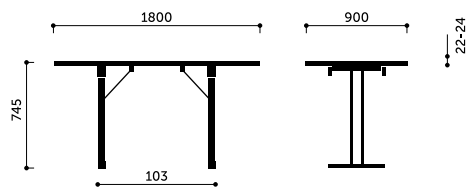

Standard Folding Table 4680-10

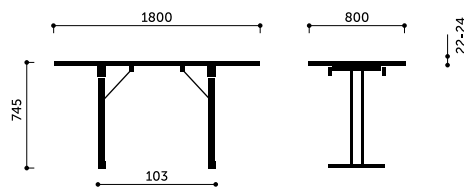

Standard Folding Table 4680-22

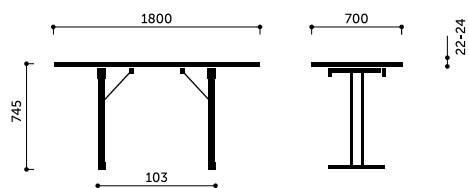

Standard Folding Table 4680-36

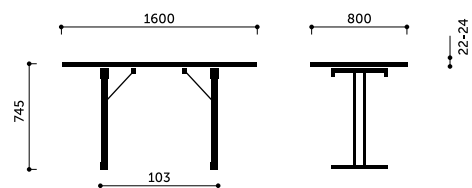

Standard Folding Table 4680-24

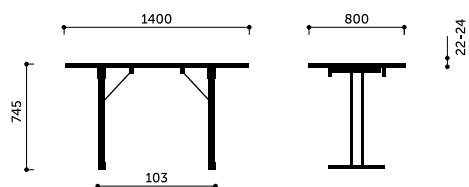

Standard Folding Table 4680-25

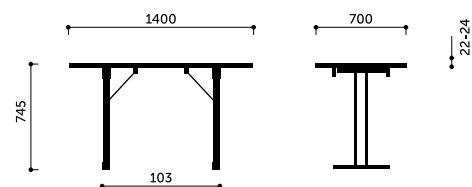

Standard Folding Table 4680-38

Technical details

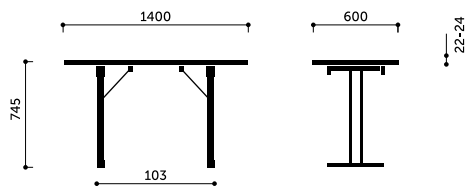

Standard Folding Table 4680-52

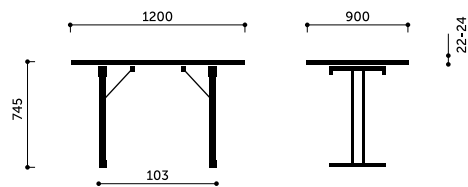

Standard Folding Table 4680-15

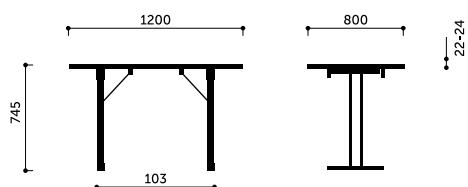

Standard Folding Table 4680-27

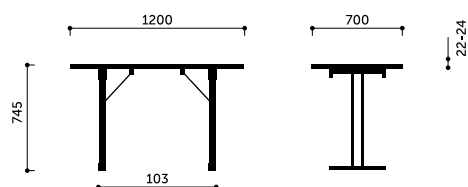

Standard Folding Table 4680-39

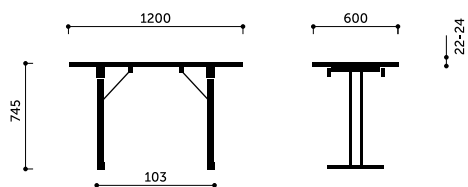

Standard Folding Table 4680-54

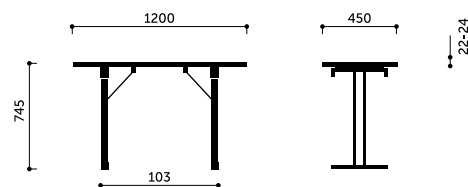

Standard Folding Table 4680-90

Technical details

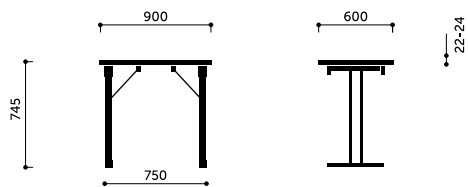

Standard Folding Table 4680-58

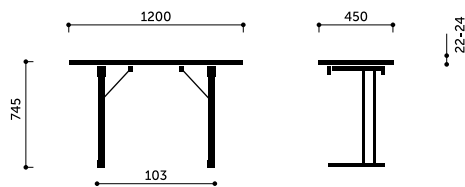

Standard Folding Table 4688-90

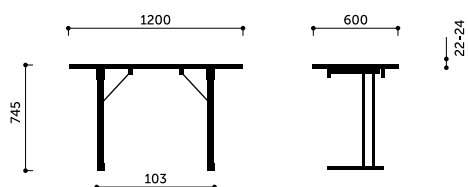

Standard Folding Table 4688-54

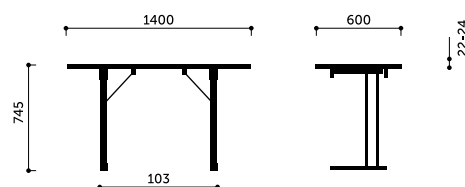

Standard Folding Table 4688-52

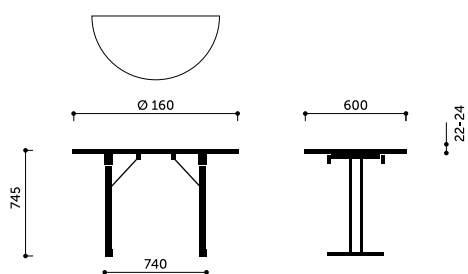

Standard Folding Table 4681-45

Technical details

Tables

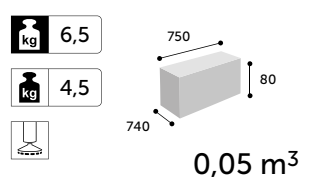
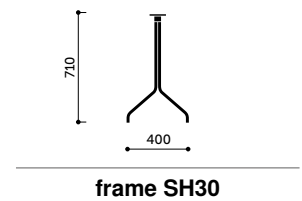
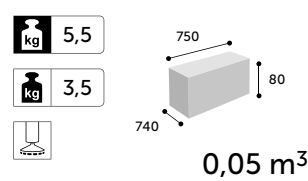
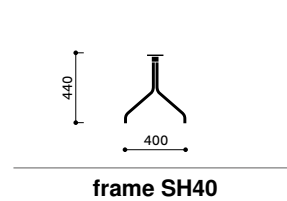
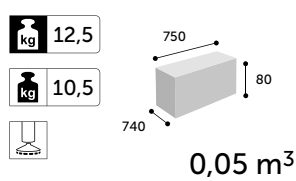
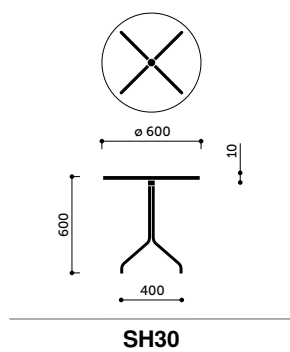
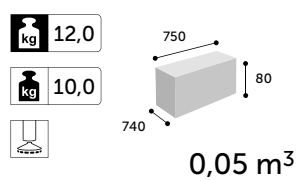
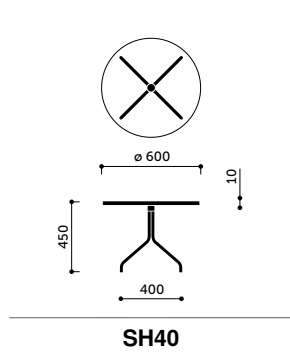
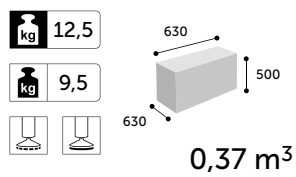
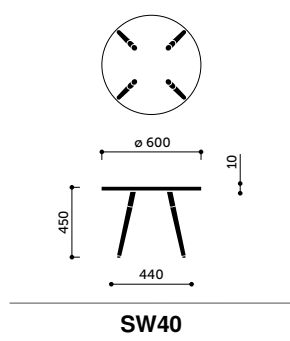
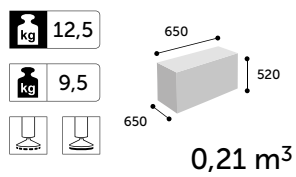
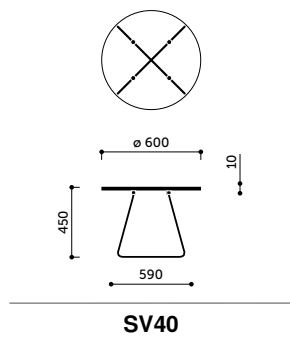

26% rabatt ska dras av på angivna priser

Technical details

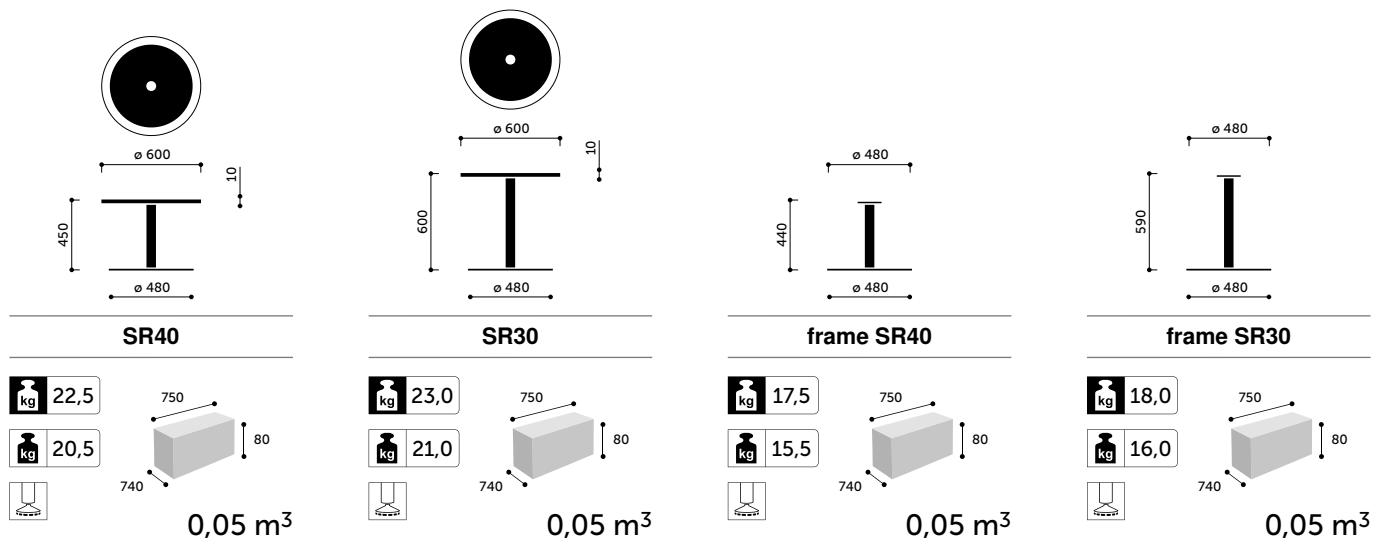

Trillo^{Pro}

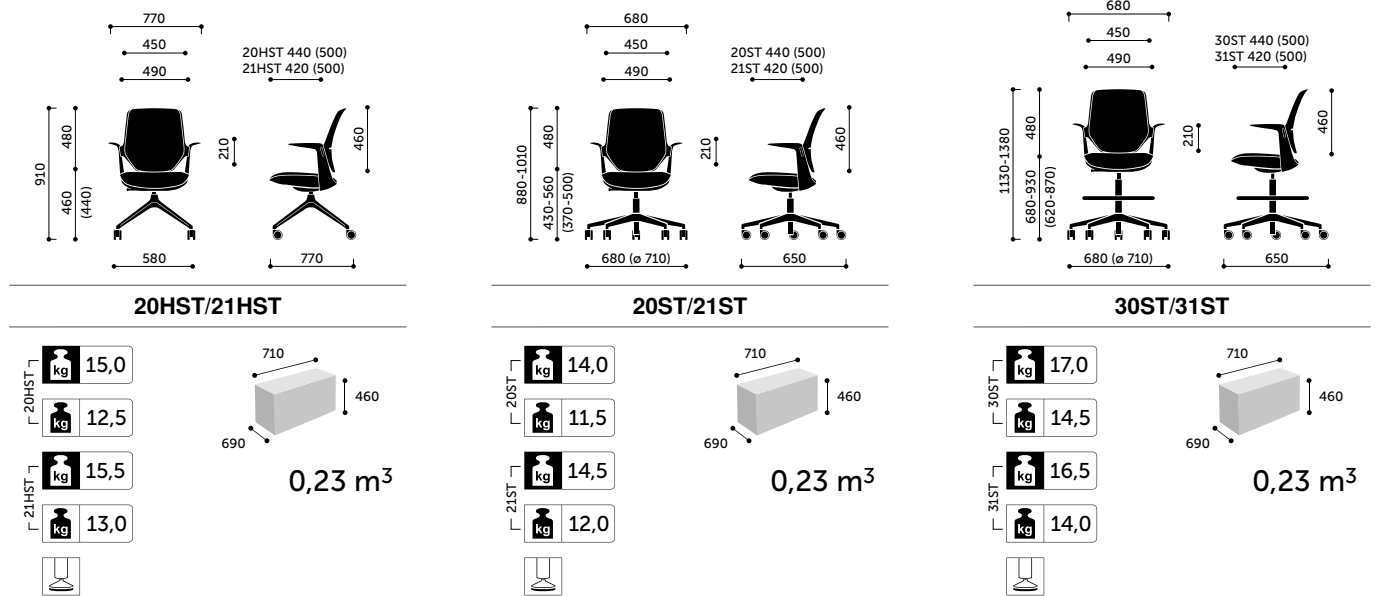

26% rabatt ska dras av på angivna priser

Technical details

Trillo^{Pro}

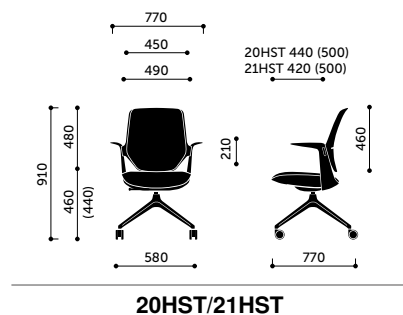

20HST/21HST

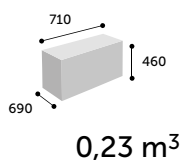
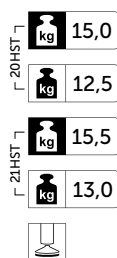

u-Connect

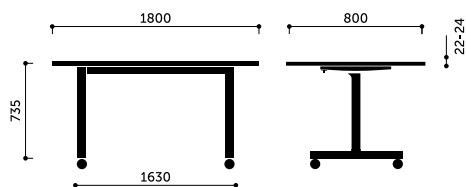

u-Connect 3490-22

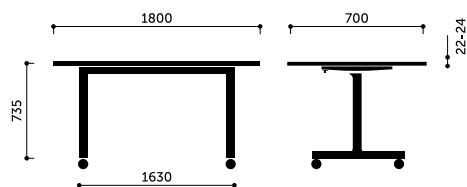

u-Connect 3490-36

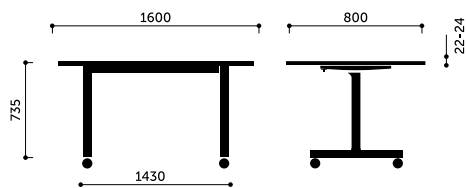

u-Connect 3490-24

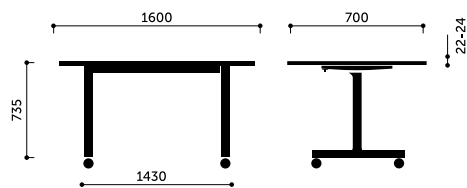

u-Connect 3490-37

26% rabatt ska dras av på angivna priser

Technical details

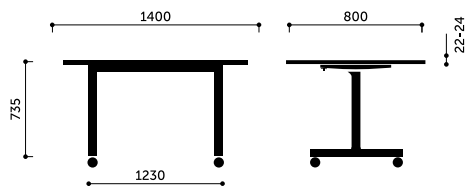

u-Connect 3490-25

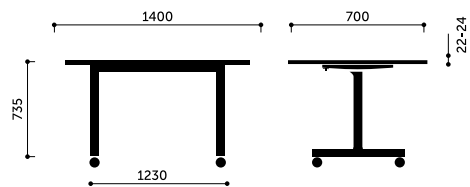

u-Connect 3490-38

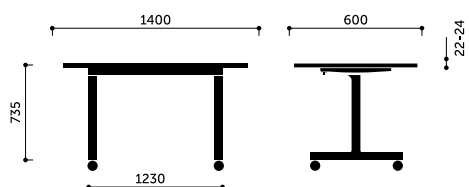

u-Connect 3490-52

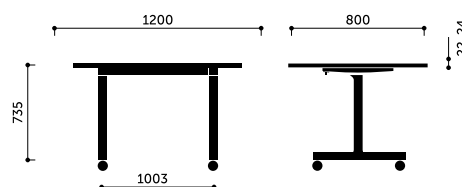

u-Connect 3490-27

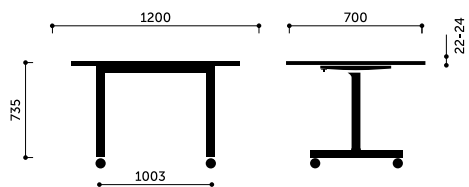

u-Connect 3490-39

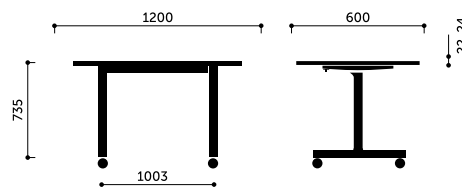

u-Connect 3490-54

26% rabatt ska dras av på angivna priser

Technical details

Vancouver Lite

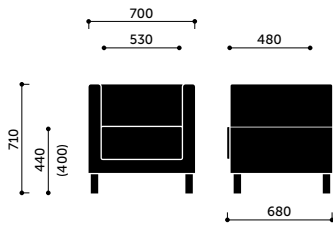

VL1 H / VL1 V

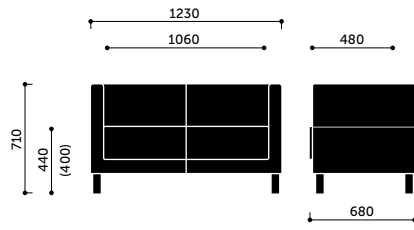

VL2 H / VL2 V

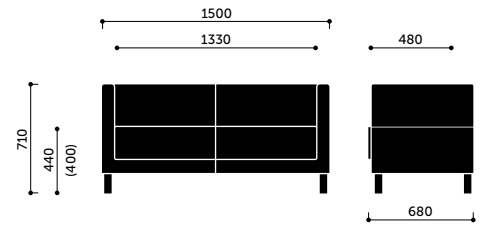

VL2,5 H / VL2,5 V

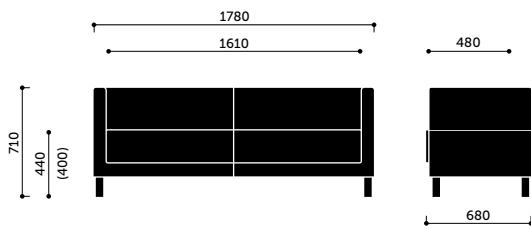
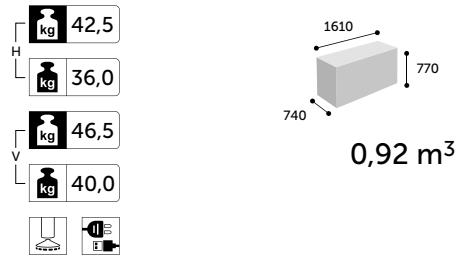
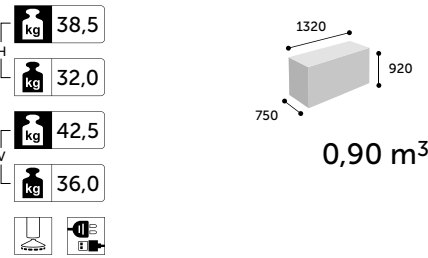
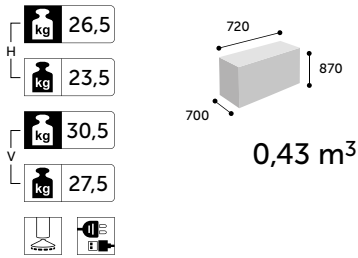

VL3 H / VL3 V

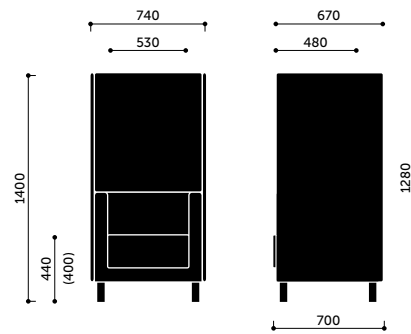

VL1 HW / VL1 VW + VL W1

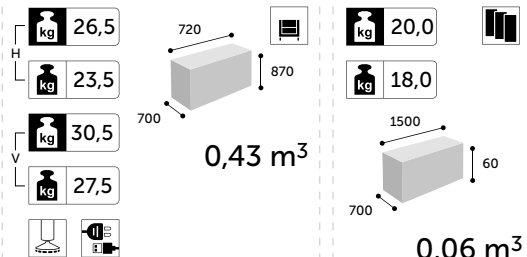

26% rabatt ska dras av på angivna priser

Technical details

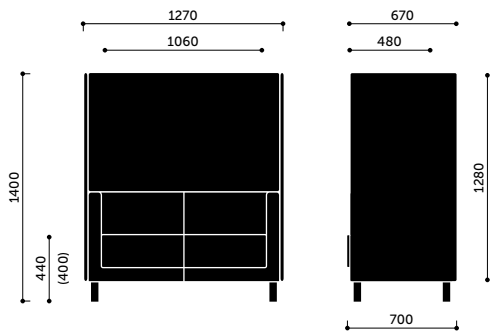

VL2 HW / VL2 VW + VL W2

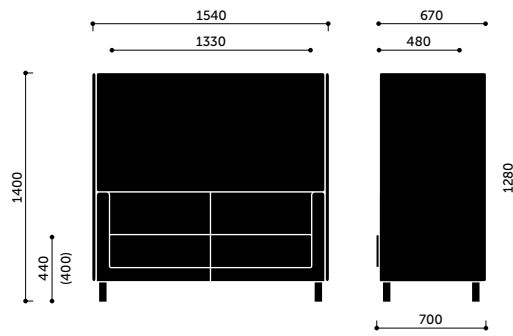

VL2,5 HW / VL2,5 VW + VL W2,5

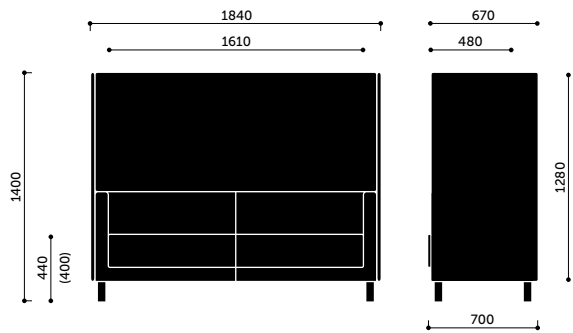
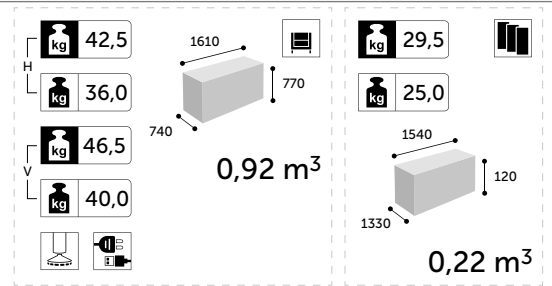
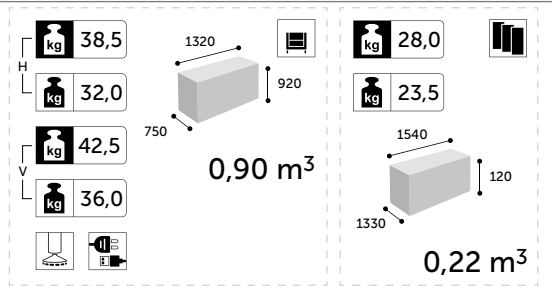

VL3 HW / VL3 VW + VL W3

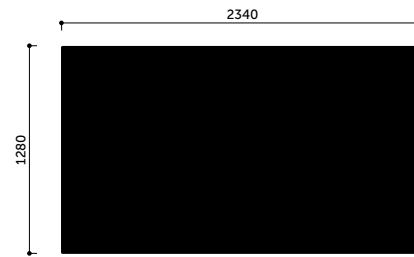

VL SW / VL SW HA

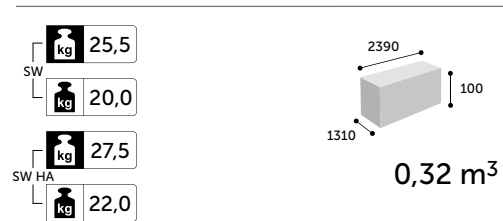
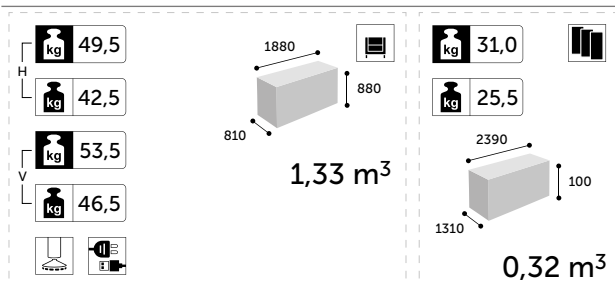

26% rabatt ska dras av på angivna priser

Technical details

Vancouver Oto

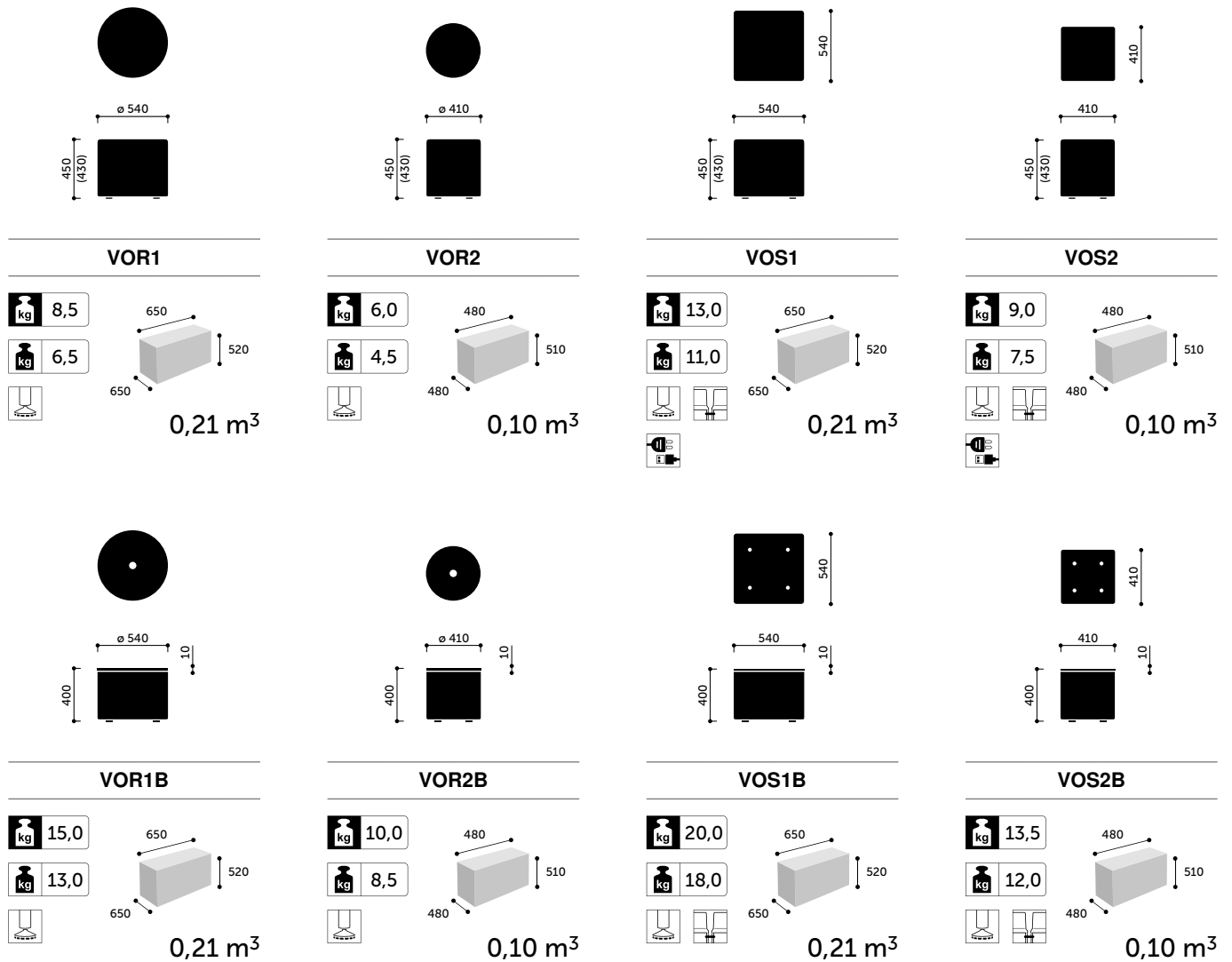

Wall In

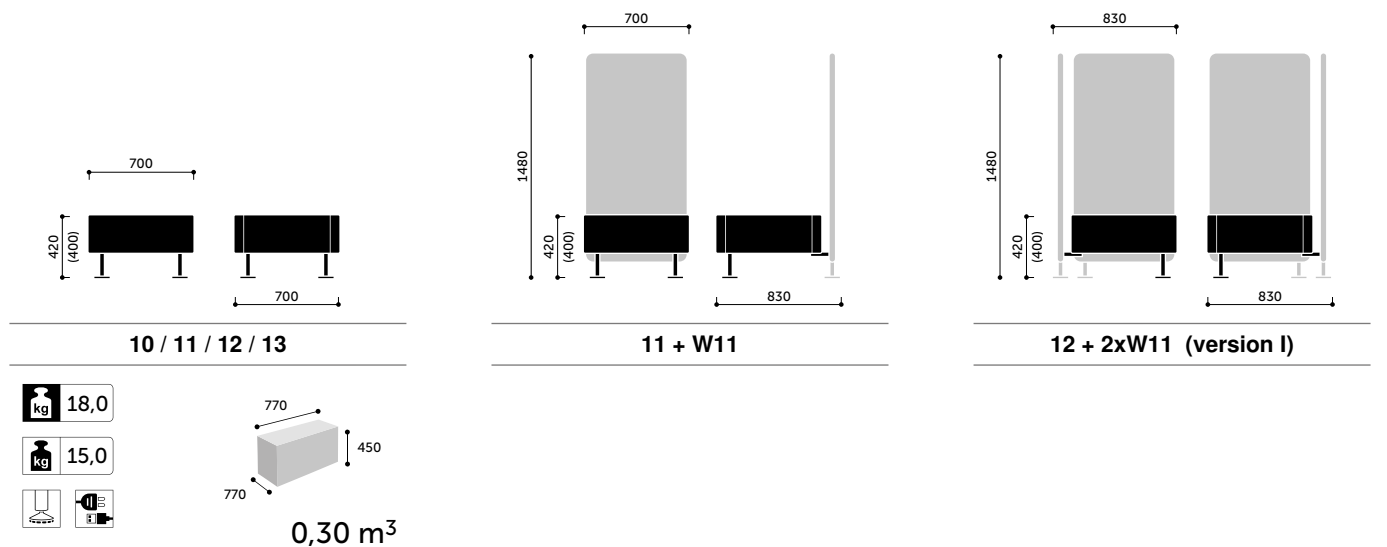

26% rabatt ska dras av på angivna priser

Technical details

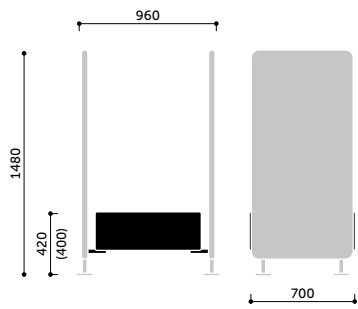

12 + 2xW11 (version II)

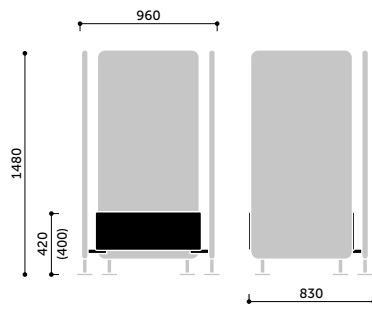

13 + 3xW11

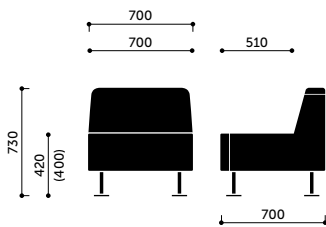

20 / 21 / 22 / 23

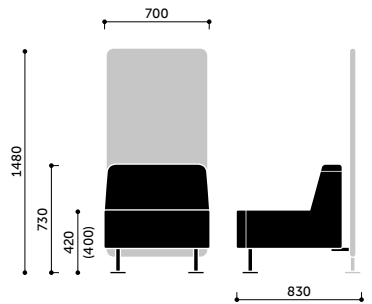

21 + W11

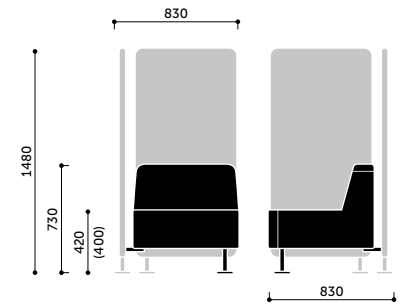

22 + 2xW11 (version I)

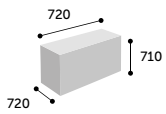
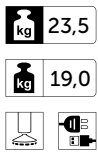

0,35 m³

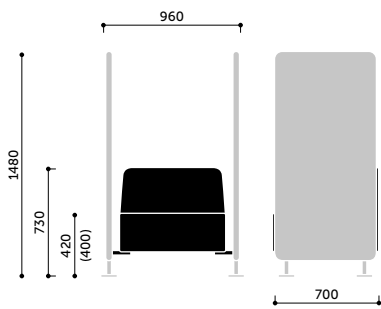

22 + 2xW11 (version II)

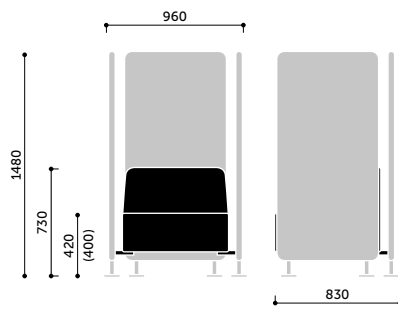

23 + 3xW11

26% rabatt ska dras av på angivna priser

Technical details

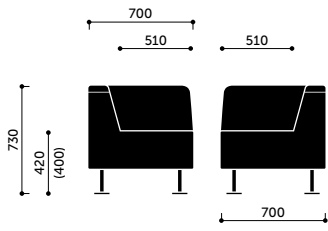

30 / 31 / 32

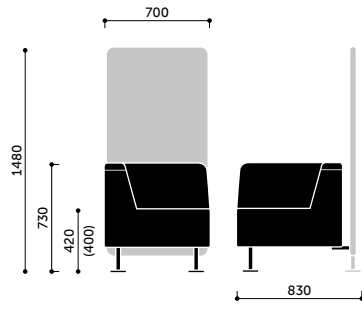

31

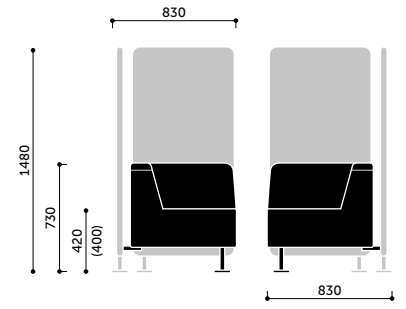

32

kg 24,5

kg 20,0

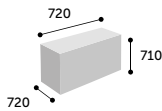

0,35 m³

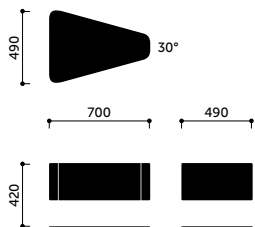

C1

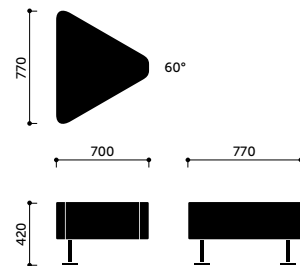

C2

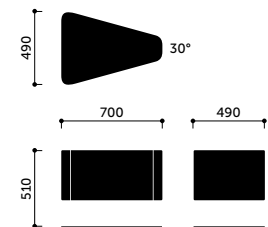

P1

kg 8,5

kg 7,0

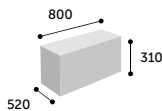

0,13 m³

kg 11,5

kg 9,0

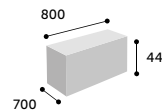

0,25 m³

kg 12,0

kg 9,5

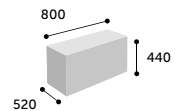

0,20 m³

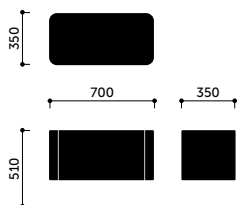

P3

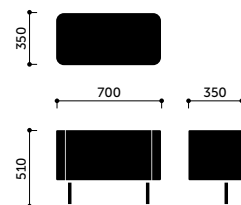

P4

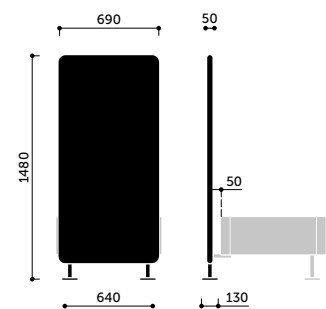

W11 / W12

kg 12,5

kg 10,0

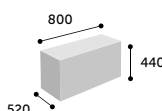

0,20 m³

kg 13,5

kg 11,0

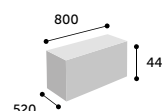

0,20 m³

kg 11,5

kg 9,5

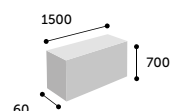

0,06 m³

26% rabatt ska dras av på angivna priser

Technical details

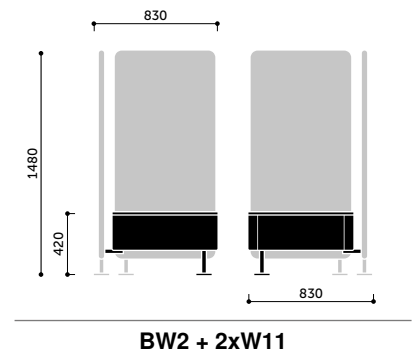
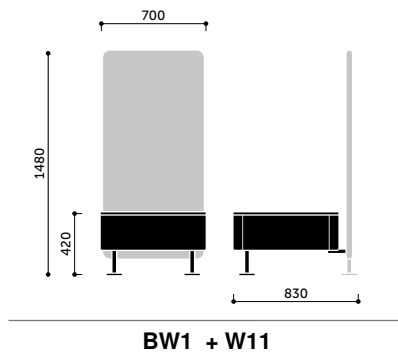
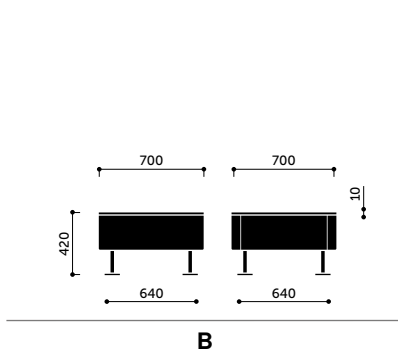

- 28,5
- 25,5
-

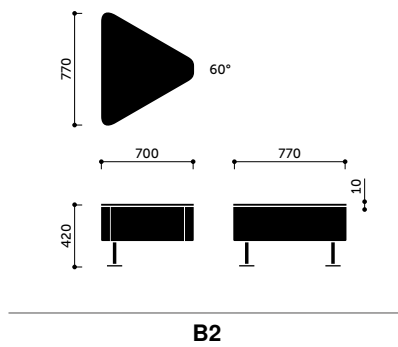
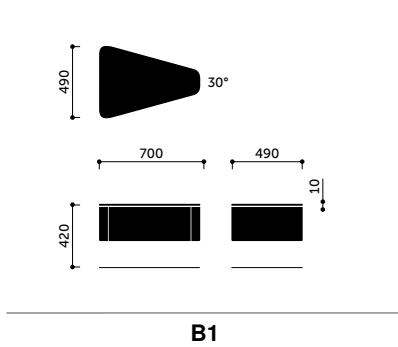
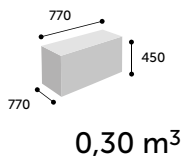

- 14,5
- 13,0
-

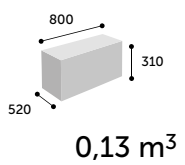

- 20,5
- 18,0
-

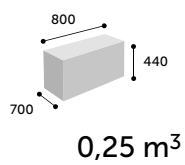

26% rabatt ska dras av på angivna priser

Technical details

Zoo

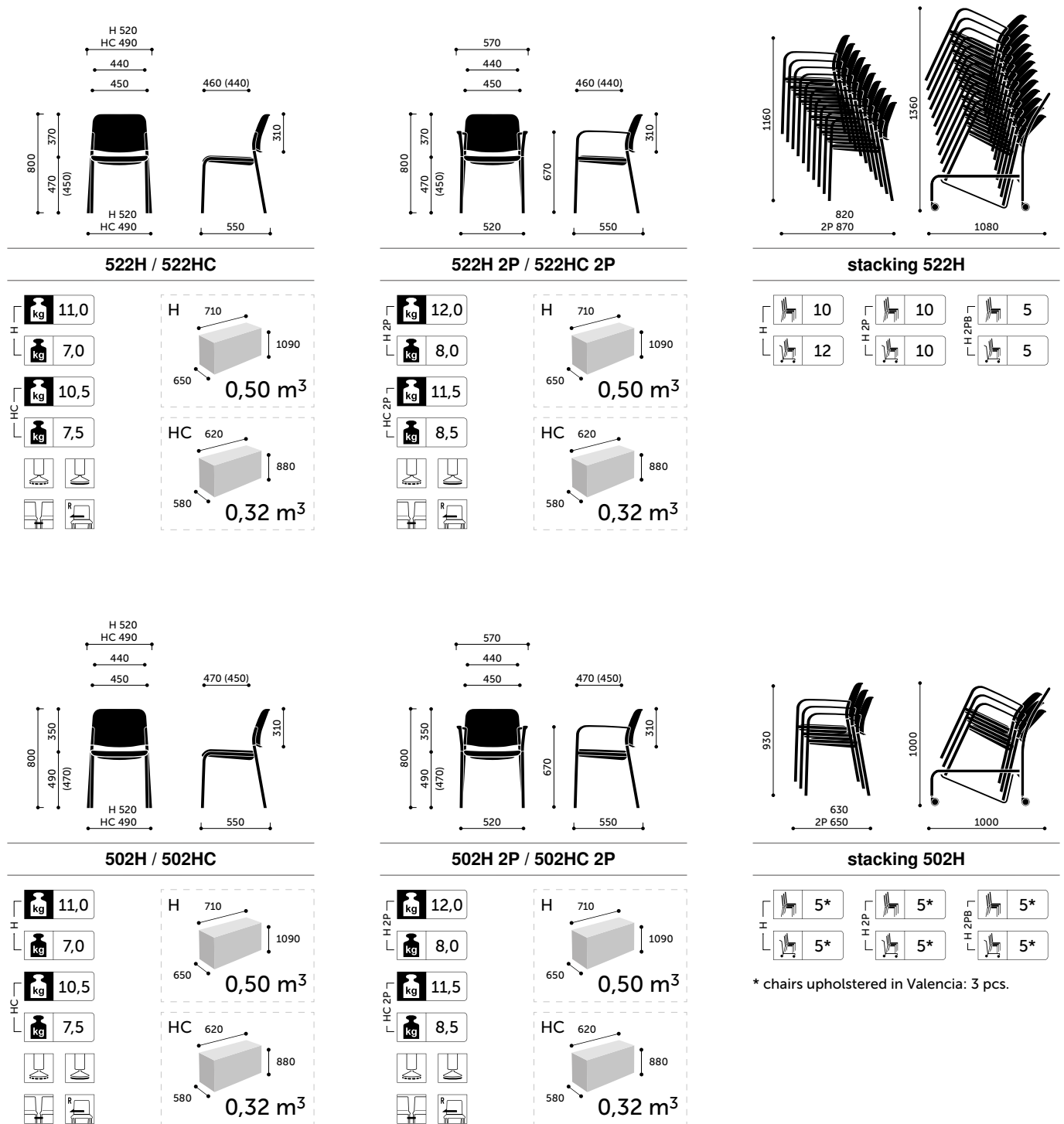

* chairs upholstered in Valencia: 3 pcs.

26% rabatt ska dras av på angivna priser

Technical details

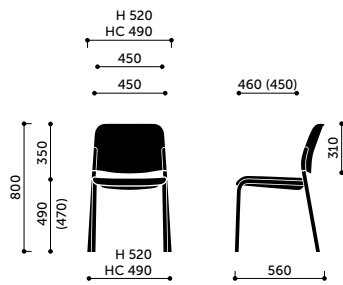

500H / 500HC

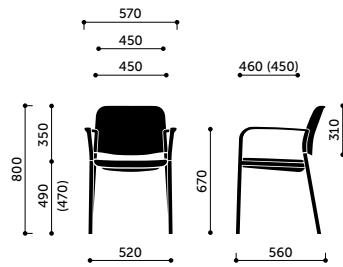

500H 2P / 500HC 2P

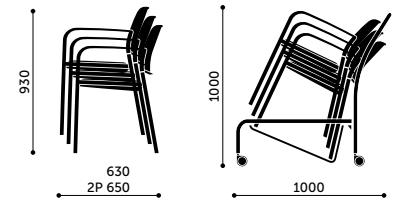

stacking 500H

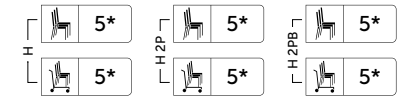
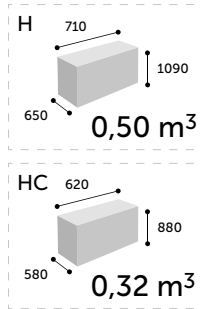
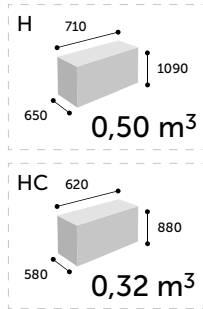
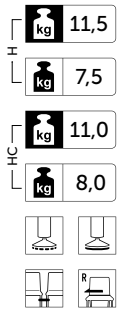

* chairs upholstered in Valencia: 3 pcs.

26% rabatt ska dras av på angivna priser

Castors / glides

Castors / glides	Models	Type	Castors / glides	Models	Type
	Ellie ^{Pro} , Noor, Trillo ^{Pro}	soft / hard (ø 65 mm)		Com V	felt / teflon
	Trillo ^{Pro} 30ST/31ST	soft / hard (ø 65 mm)		Chic H	felt / teflon
	Acos ^{Pro} 30VN	felt / teflon		Chic 20F, Fan 10F, Nu 20F	felt / teflon
	Acos ^{Pro} 30H	felt / teflon		Chic 20HW, Nu 20HW	felt / teflon
	Ariz - without armrests	felt / teflon		Ellie ^{Pro} 10HW, Ellie ^{Pro} 20HW	felt / teflon
	Ariz - with armrests	felt / teflon		Chic Lounge V3, Nu 20V3	felt / teflon
	Bit H	felt / teflon		Ellie ^{Pro} 10V3, Ellie ^{Pro} 20V3	felt / teflon
	Bit V, Zoo H	felt / teflon		Ellie ^{Pro} 10ST, Ellie ^{Pro} 20ST, Ellie ^{Pro} 10HST, Ellie ^{Pro} 20HST, Trillo ^{Pro} 20, Trillo ^{Pro} 21, Nu HC	teflon (ø 50 mm)
	Com H	felt / teflon		Fan 10H, Fan 10HS, Nu 20HS	felt / teflon
	Com V1	felt / teflon		Fan 10HW	felt / teflon
	Com V2	felt / teflon		Fan 10V, Fan 20V	felt / teflon
	Ana	felt / hard			

26% rabatt ska dras av på angivna priser









Castors / glides

Castors / glides	Models	Type
	Fan 10HC, Fan 10Z, Fan 10E, Nu 20HC	Universal (ø 65 mm)
	Com HC, Normo HC	Universal (ø 55 mm)
	Fan 10Z, Fan 10E	teflon
	Sorriso 10V	felt / teflon
	Noor 6090/6095	felt / hard
	Noor 6060/6065	felt / hard
	Noor 6050/6055	felt / hard
	Noor 6080/6085	felt / hard

Castors are equipped with a brake that prevents the chair from "moving away" without a load.
In models LightUp 330ST/350ST and Trillo^{Pro} 30ST/31ST castors are equipped with a reverse brake that prevents the chair from "moving away" with a load.





26% rabatt ska dras av på angivna priser

Bases

Base	Applied to the models	Colour	Type of material	Diameter (mm)
	Ellie ^{Pro} 10HST, Ellie ^{Pro} 20HST, Trillo ^{Pro} 20HST, Trillo ^{Pro} 21HST, Nu HC	black	aluminium powder coated aluminum	770
	Ellie ^{Pro} 10HST, Ellie ^{Pro} 20HST, Trillo ^{Pro} 20HST, Trillo ^{Pro} 21HST, Nu HC	white	powder coated aluminum	770
	Ellie ^{Pro} 10HST, Ellie ^{Pro} 20HST, Trillo ^{Pro} 20HST, Trillo ^{Pro} 21HST, Nu HC	graphite	powder coated aluminum	770
	Ellie ^{Pro} 10HST, Ellie ^{Pro} 20HST, Trillo ^{Pro} 20HST, Trillo ^{Pro} 21HST, Nu HC	polished aluminum	aluminium	770
	Ellie ^{Pro} 10ST, Ellie ^{Pro} 20ST	black	plastic - polyamide	710
	Ellie ^{Pro} 10ST, Ellie ^{Pro} 20ST	light grey	plastic - polyamide	710
	Noor 6070, Noor 6075	polished aluminum	aluminium	665
	Noor 6070, Noor 6075	black	aluminium	665
	Noor 6070, Noor 6075	white	aluminum	665

26% rabatt ska dras av på angivna priser

Bases

Base	Applied to the models	Colour	Type of material	Diameter (mm)
	Fan	black	plastic - polyamide	720
	Fan	MetallicPro	powder coated aluminum	720
	Fan	polished aluminum	aluminum	720
	Sorriso 10F	polished aluminum	aluminium	760
	Fan 10F, Nu 20F	polished aluminum	aluminium	700

26% rabatt ska dras av på angivna priser

Mechanisms



Rocker

Fan 10Z

A - Seat height
B - Tilt angle of the backrest and the seat



Economic

Fan 10E

A - Seat height



Economic

Noor 6070/6075

A - Seat height



Synchro Self*

Trillo^{Pro}, Ellie^{Pro}

A - Seat height
B - Tilt angle of the backrest and the seat



Synchro Self*

Trillo^{Pro}, Ellie^{Pro}

A - Tilt angle of the backrest and the seat



Rocker

MyTurn 10FZ, 20FZ

A - Seat height (only in Z models)
B - Tilt angle of the backrest and the seat

The Synchro mechanisms used in Profim products are equipped with Anti-Shock system after releasing the mechanism, the back does not hit the sitting person, but remains in the previous position. The Synchro mechanism is activated only when the person leans on the backrest again.

26% rabatt ska dras av på angivna priser

Linking parts

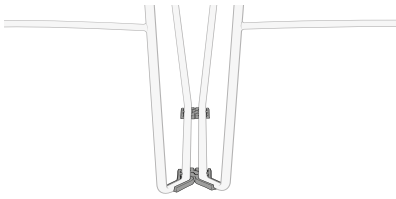

Linking part Ariz

Price - no extra charge.

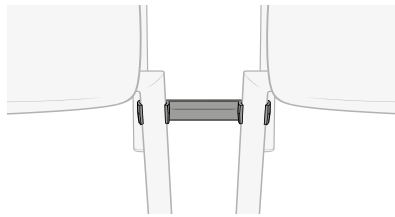

Universal FIXED 1 Linking part

Available in models without armrests: Bit.

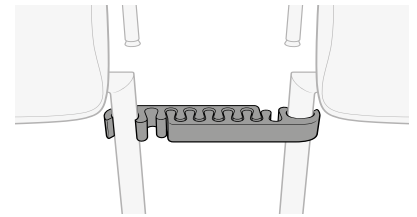

Universal ADJUSTABLE Linking part

Available in Bit without armrests.
Available in Com.

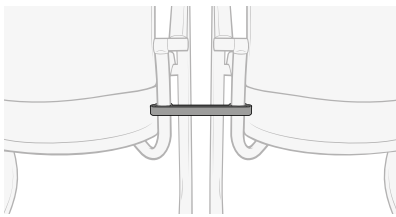

Universal FIXED 2 Linking part

Available in models: Acos^{PRO}.

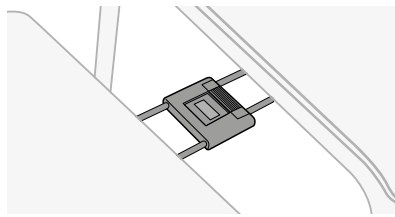

Linking part Com, Zoo

Available in 4-legged Com and Zoo.

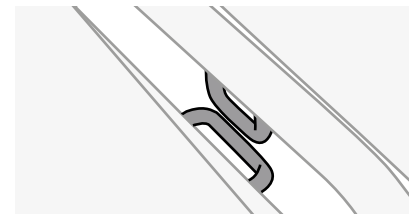

Linking part Ana

Available in Ana.

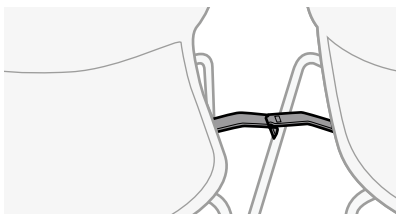

Linking part Noor

Available in Noor.

26% rabatt ska dras av på angivna priser

Stacking

	Maximum quantity in stack (pc.)	Maximum quantity in stack on trolley (pc.)
Acos^{Pro}		
30V	2	-
Ana		
4340	12	-
4340S	10	-
4340SR	7	-
Ariz		
550V, 555V	15	45
550V 2P, 555V 2P	10	45
560V, 560V 2P	5	20
570V, 570V 2P	5	20
575V, 575V 2P	5	20
550CV	2	-
555CV	2	-
560CV	2	-
570CV	2	-
575CV	2	-
Bit		
550H, 550H 2P	5	-
555H, 555H 2P	5	-
560H, 560H 2P	3	-
570H, 570H 2P	3	-
575H, 575H 2P	3	-
550V, 550V 2P	3	-
555V, 555V 2P	3	-
560V, 560V 2P	3	-
570V, 570V 2P	3	-
575V, 575V 2P	3	-
Com		
12H (+2P)	15	15
12H 2PB	5	5
12V1 (+2P)	5	5
12V2	5	5
12V	15	15
22H (+2P)	12	12
22H 2PB	5	5
22V1 (+2P)	5	5
22V2	5	5
22V	12	12
32H (+2P)	12	12
32H 2PB	5	5

	Maximum quantity in stack (pc.)	Maximum quantity in stack on trolley (pc.)
32V1 (+2P)	5	5
32V2	5	5
32V	12	12
42H (+2P)	10	10
42H 2PB	5	5
42V1 (+2P)	5	5
42V2	5	5
42V	10	10
Noor		
4-leg 6050/6055	10	-
4-leg 6050/6055 with armrests	10	-
4-leg 6060/6065	5	-
4-leg 6060/6065 with armrests	5	-
Normo		
H, H LP, H SP	4	-
V, V SP	4	-
Zoo		
522H	10	12
522H 2P	10	10
522H 2PB	5	5
502H, 502H 2P, 502H 2PB	5*	5*
500H, 500H 2P, 500H 2PB	5*	5*

* Chairs upholstered in Valencia - 3 pcs.

26% rabatt ska dras av på angivna priser

Glides, table tops, joining in rows

	Joining in rows	Felt glides (for hard surfaces)	Teflon glides (universal)	Left-sided table top	Right-sided table top
Ana	•	•		•	•
Ariz	•	•	•	•	•
Bit	•	•	•		
Chic		•	•		
Chic Lounge		•	•		
Chic Tables		•	•		
Com	•	•	•	•	
Ellie ^{Pro}		•	•		
Fan		•	•		
Mickey			•		
MyTurn Sofa		•			
Noor	•	•			
Normo		•	•		
Nu		•	•		
October		•			
Revo			•		
Revo Tables		•			
Seven					
SoftBox	•	•			
Sorriso		•	•		
Tables SH/SR/SV/SW		•	•		
Trillo ^{Pro}			•		
Vancouver Lite		•			
Vancouver Oto	•	•			
Wall In	•	•			
Zoo	•	•	•	•	

Details in additional information on specific models.

26% rabatt ska dras av på angivna priser

Consumption of fabric and leather

The quantities below are only estimated. The real quantity of fabric- or leather-consumption may vary in accordance to the quantity of pieces on order. Please notice that before we accept any order in customer's own material we need to make sample trials. Please be aware that not every type of fabric/leather is suitable for upholstery. Volume of customer's own material must be agreed each time with Profim sales organization

Column A - Estimated consumption of fabric (roll width: 1,40 m)

Column B - Estimated consumption of leather (m²)

	A	B		A	B		A	B
Acos^{Pro}			Ellie^{Pro}			Revo		
30H, 30HC, 30V	1,2	1,8	10	2,5	-	P40	1,5	-
			20	2,4	-	P60	2,2	-
Ariz			Fan			SW120	2,4	-
560, 575	0,6	-	10	1,4	1,9	SW180	3,2	-
570	1,6	-	20	2,4	3,3	SW240	3,9	-
Bit			cushion	0,5	0,5	SN150	2,6	-
560, 575	0,6	-	Mickey			SN210	3,3	-
570	1,0	-	seating	0,7	-	B90	1,2	-
580	1,2	-	side of the base	0,25	-	B120	1,5	-
Chic			MyTurn Sofa			B180	2,1	-
10	2,2	3,5	10	3,8	7,4	W90	2,9	-
20	1,2	1,4	20	6,0	10,0	W120	3,8	-
21	1,0	1,1	30	8,7	13,0	W180	5,6	-
Chic Lounge			Normo			SoftBox		
A10	2,2	4,0	500	1,0	-	10, S2	2,2	2,4
A20	2,1	3,3	Nu			1C	2,5	4,0
PV3	1,2	1,6	20	1,6	-	11	3,2	5,5
CU	0,4	0,3	October			20	3,0	4,0
Cushion			10	2,0	2,1	2B	4,4	6,0
CU30	0,4	-	20	3,5	4,0	2R, 2L	4,8	6,5
CU40	0,5	-	11	3,6	5,7	21	4,5	7,2
Com			21	5,5	9,2	3B	6,6	8,7
22	0,5	0,3	31	7,7	12,2	3R, 3L	5,8	8,9
32	1,0	0,7	12	6,5	8,5	31	5,9	9,6
42	1,1	1,1	22	8,0	12,5	1CW*	1,6	-
22CV	0,5	0,3	32	10,5	18,5	11W*	1,8	-
42CV	0,7	0,8				2BW*	1,7	-
						2RW*, 2LW*	2,1	-
						21W*	2,6	-
						3BW*	2,4	-
						3RW*, 3LW*	2,9	-
						31W *	3,3	-

*refers only to screens

26% rabatt ska dras av på angivna priser

Consumption of fabric and leather

	A	B		A	B
Sorriso			Wall In		
10	2,1	2,6	10, 11, 12, 13, B	1,5	2,0
Trillo^{Pro}			20, 21	1,8	2,7
20	0,6	-	22, 23	1,8	2,7
21	1,2	-	30, 31, 32	2,3	3,2
Vancouver Lite			C1, B1	1,6	1,4
1 H/V	2,6	4,1	C2, B2, P1	1,6	1,7
2 H/V	3,6	5,9	P3, P4	1,2	1,7
2,5 H/V	4,0	6,7	W	1,7	-
3 H/V	5,1	8,4	Zoo		
1 HW/VW	1,9	3,2	502	0,7	-
2 HW/VW	2,6	4,8	500	1,1	-
2,5 HV/VW	2,9	5,5			
3 HV/VW	3,5	6,5			
W1	6,7	-			
W2	6,7	-			
W2,5	8,9	-			
W3	8,9	-			
SW	5,5	-			
Vancouver Oto					
R1, R1B	1,2	1,6			
R2, R2B	1,0	1,1			
S1, S1B	1,8	2,6			
S2, S2B	1,1	1,3			

26% rabatt ska dras av på angivna priser

Quilting



Bit / Com

Q1 - quilting on the seat pad
Q2 - quilting on the backrest pad



Acos^{Pro} / Com

Q3 - quilting on the whole front part
Q4 - quilting on the whole rear part



Nu / Sorriso

Q5 - quilting on the seat cushion

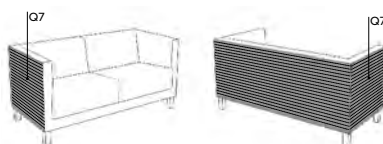

MyTurn Sofa / Vancouver Lite

Q7 - quilting on the outer part of the sides and the back

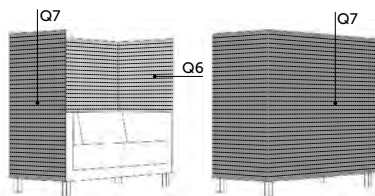

Vancouver Lite

Q6 - quilting on the inner part of the wall
Q7 - quilting on the outer part of the wall

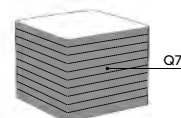

Vancouver Oto

Q7 - quilting on all of the sides

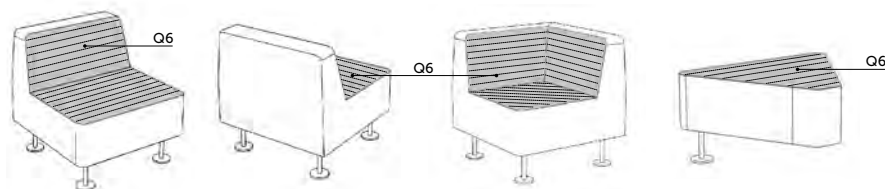

Wall In

Q6 - quilting on the seat and backrest

Measuring methodology

Swivel armchairs and chairs are measured with a mechanism adjusted in such a way that the seat is as much as it is possible positioned levelly, while the backrest vertically. Swivel armchairs and chairs are measured on their castors, whereas visitor and reception chairs on hard glides. The measurements are approximate and can differ depending on the product configuration.

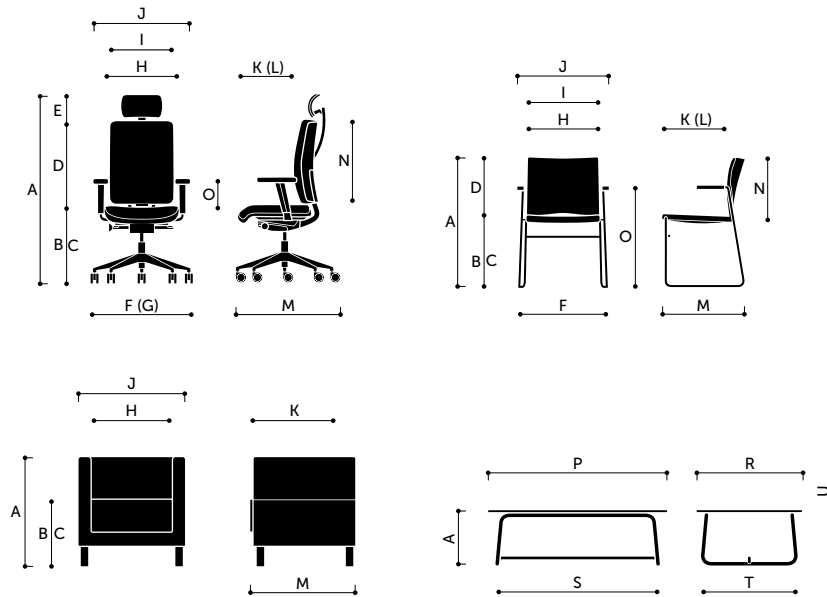

A - Total height

For products fitted with a gas lift - it is measured with gas lift's minimum and maximum extension. For products fitted with an additional backrest and headrest height adjustment - it is measured in both minimum and maximum positions of the backrest, headrest and gas lift.

B - Seat height

Measured at the highest point of the seat. For products fitted with a gas lift - it is measured with absorber's minimum and maximum extension.

C - Seat height with the burden

Seat measured according to EN standards (with seat burden). For products fitted with a gas lift - it is measured with gas lift's minimum and maximum extension.

D - Backrest height

Measured from the seat to the backrest upper edge. For products with adjustable backrest height - it is measured in the minimum and maximum position.

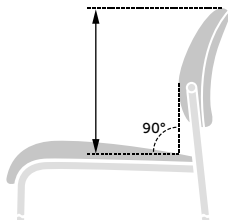

E - Headrest height

Measured from the backrest upper edge to the headrest upper edge. The headrest adjusted in maximum vertical position in relation to the upper and lower edge of the headrest. Measured in the headrest's minimum and maximum position.

F - Base, frame width

Measured at the uttermost points of the base according to the following figures.

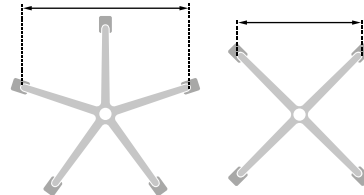

G - Base diameter

Measured according to the figure underneath.

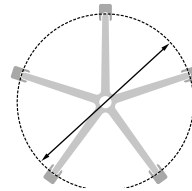

H - Seat width

Measured at the uttermost points of the seat.

I - Backrest width

Measured at the uttermost points of the backrest.

J - Total width

Measured at the uttermost points. For products fitted with adjustable armrests - it is measured with the armrests slid apart to maximum. For products fitted with armrests with adjustable pads - it is measured with the pads slid apart to maximum.

Measuring methodology

K - Seat depth

Measuring the distance between the uttermost point on the seat and the point it touches the backrest (the contact point is determined with a level positioned vertically to the backrest by projecting the S point from the backrest onto the seat) (1). For some shell chairs, where there is no distinct border-line between the seat and the backrest, the depth is measured on the bend halfway between the seat and the backrest (2). For products with additional adjustable seat depth - it is measured with minimum and maximum slide.

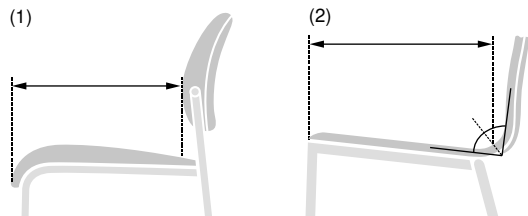

L - Seat (element) length

Measured at the uttermost points of the seat.

M - Total depth

Measured at the uttermost points. Swivel armchairs and chairs are measured according to the drawing underneath. For products with adjustable seat depth - it is measured with minimum and maximum slide.

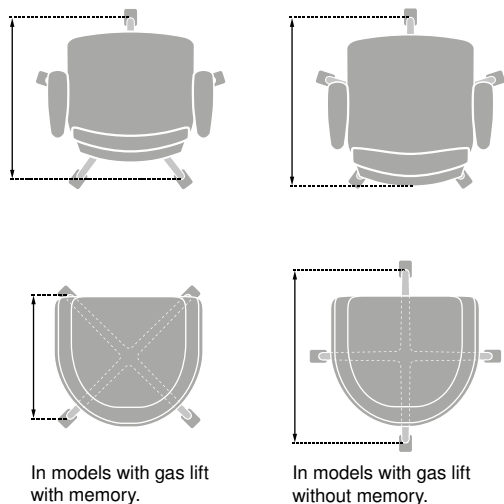

N - Backrest (element) length

Measured at the uttermost points of the backrest.

O - Armrest height

For swivel armchairs and chairs – it is measured from the seat surface to the armrest upper edge. For armrests with adjustable height – it is measured in the minimum and maximum position. For visitor chairs – it is measured from the floor to the armrest upper edge.

P - Table top length

Measured at the uttermost points of the table top.

R - Table top width

Measured at the uttermost points of the table top.

S - Table frame length

Measured at the uttermost points of the table frame.

T - Table frame width

Measured at the uttermost points of the table frame.

U - Table top thickness

Table top (element) thickness is measured.

Fabrics and finishings

Profim Standard fabrics

EVO - PRICE GROUP 0

Evo is a uni-coloured polyester crepe fabric. The irregular weave structure add shine and good stretch.

Composition: 100% polyester

Weight: 320 g/m²

Abrasion resistance: 180 000 Martindale (EN ISO 12947-2)

Flammability: BS EN 1021: 1-2 (Cigarette & match)

Light fastness: 4-5 (EN ISO 105-B02)

Rubbing fastness: 4-5 (Wet/Dry) (EN ISO 105-X12)

Pilling resistance: 5 (EN ISO 12945-2)

Environmental facts: EU Ecolabel, Oeko-Tex® Standard 100, ISO 14001 certified company

Design: Miranda Design Team

Produced in: Poland

Cleaning & disinfection: Dry cleaning with tetrachloroethylene and water solution of carbonate fluoride

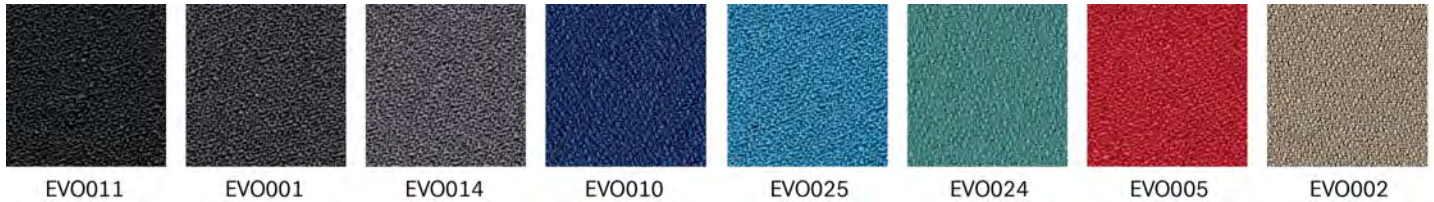

CURA (GABRIEL) - PRICE GROUP 1

Cura is a two-coloured fabric made from 98% post-consumer recycled polyester. It has a matt, slightly irregular and natural-looking texture where the dark, underlying grey fibers create a discreet yet vibrant melange effect. High durability and stretchability and its soft, voluminous touch make Cura suitable for both office and lounge furniture.

Composition: 98% post-consumer recycled polyester, 2% polyester

Weight: 420 g/m²

Abrasion resistance: 100 000 Martindale (EN ISO 12947-2)

Flammability: BS EN 1021: 1-2, BS 5852 0&1, CA TB 117-2013, ASTM E 84 Class I

Light fastness: 5-8 (EN ISO 105 - B02)

Rubbing fastness: 4-5/4-5 (Wet/Dry) (EN ISO 105X12)

Pilling: 4-5 (EN ISO 12945-2)

Environmental facts: EU Ecolabel, Oeko-Tex® Standard 100, Contains no Flame Retardant chemicals, ISO 14001 certified company

Design: Cenk Kivrikoglu

Produced in: Lithuania

Cleaning: Wash or dry cleaning, Can be disinfected with ethanol and is bleach-cleanable (For further info follow Gabriel´s cleaning guidelines – www.gabriel.dk)



26% rabatt ska dras av på angivna priser

TONAL (GABRIEL) - PRICE GROUP 1

Tonal is a post-consumer recycled polyester fabric in a two-coloured melange. It has a discreet textured look with a fusion of light and dark tones adding depth to the colours.

Composition: 99% post-consumer recycled polyester, 1% polyester

Weight: 315 g/lm

Abrasion resistance: 100 000 Martindale (EN ISO 12947-2)

Flammability: BS EN 1021: 1-2, BS 476 Part 7 class 1, CA TB 117-2013, ASTM E 84 Class I

Light fastness: 6-8 (EN ISO 105 - B02)

Rubbing fastness: 4-5/4-5 (Wet/Dry) (EN ISO 105X12)

Pilling: 4-5 (EN ISO 12945-2)

Environmental facts: EU Ecolabel, Oeko-Tex® Standard 100, Contains no Flame Retardant chemicals, ISO 14001 certified company

Design: Cenk Kivrikoglu

Produced in: Lithuania

Cleaning: Wash or dry cleaning. Can be disinfected with ethanol and is bleach-cleanable (For further info follow Gabriel's cleaning guidelines - www.gabriel.dk)

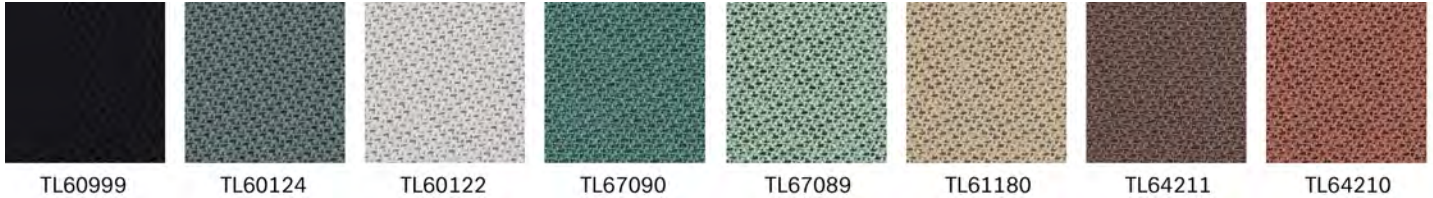

XTREME (CAMIRA) - PRICE GROUP 1

Xtreme is a crepe fabric made from 100% post-consumer recycled polyester that features exceptional Euro flammability performance. Extra stretch and structure gives an irregular, shiny finish.

Composition: 100% post-consumer recycled polyester

Weight: 310 g/m2

Abrasion resistance: >100 000 Martindale (EN ISO 12947-2)

Flammability: BS EN 1021: 1-2 (Cigarette & match), BS 7176 Low & Medium Hazard, BS 5852 Section 4 Crib 5, DIN 4102 B1, UNI 9175 Class 1 IM, NF D 60-013

Light fastness: 6 (EN ISO 105 - B02: 2013)

Rubbing fastness: 4/4 (Wet/Dry) (EN ISO 105X12)

Pilling: 5 (EN ISO 12945-2)

Environmental facts: EU Ecolabel, Oeko-Tex® Standard 100, Indoor Advantage™ "Gold", non metallic dyestuffs, ISO 14001 certified company.

Design: Camira Design Studio

Produced in: United Kingdom

Cleaning & disinfection: Washable to 60 °C and bleach cleanable (For further info follow Camira's cleaning guidelines - www.camirafabrics.com)

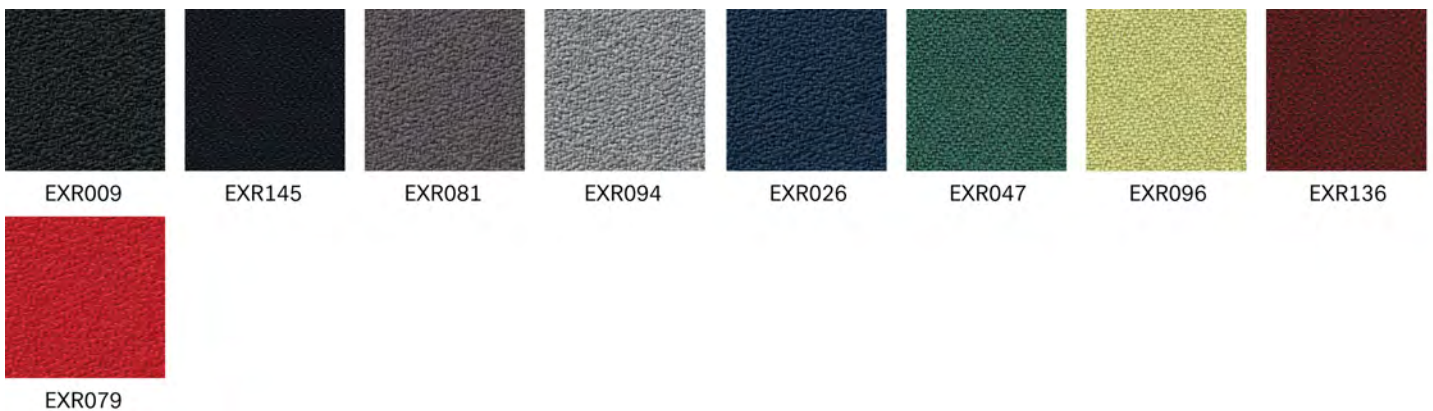

26% rabatt ska dras av på angivna priser

SELECT (GABRIEL) - PRICE GROUP 2

Select is a classic woolen fabric with a tightly woven relief structure, combining excellent softness, stretch and durability. Its rich texture with the interplay of light and shadow add depth in all the colours in the palette.

Composition: 85% New Zealand wool, 15% polyamide

Abrasion resistance: 200 000 Martindale (EN ISO 12947-2)

Flammability: BS EN 1021: 1-2, BS 5852 0&1, BS5852 Crib 5, CA TB 117-2013, IMO MSC 307(88) Annex 1 part 8/MED registration IMO

Light fastness: 5-8 (EN ISO 105 - B02)

Rubbing fastness: 4-5/4-5 (Wet/Dry) (EN ISO 105X12)

Pilling: 4 (EN ISO 12945-2)

Environmental facts: EU Ecolabel, Oeko-Tex® Standard 100, 100% free of heavy metals, ISO 14001 certified company

Design: Cenk Kivrikoglu

Produced in: Lithuania

Cleaning: Professional dry cleaning (For further info follow Gabriel's cleaning guidelines - www.gabriel.dk)

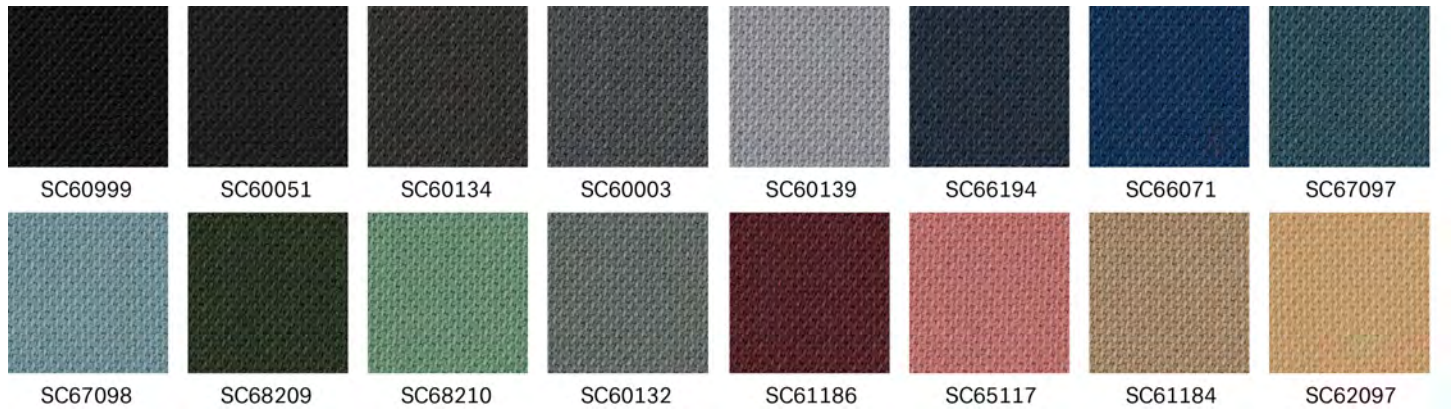

CAPTURE (GABRIEL) - PRICE GROUP 3

Capture is a lightly felted and multi-coloured wool fabric combining softness, stretch and strenght. It fuses light and dark colours to a refined melange pattern in subtle nuances, which add richness and depth to the design.

Composition: 85% New Zealand wool, 15% polyamide

Abrasion resistance: 200.000 Martindale (EN ISO 12947-2)

Flammability: BS EN 1021: 1-2 (Cigarette & match), BS 5852 Part 1 0,1 (Cigarette & match), CA TB 117-2013, Class Uno UNI 9175 Class 1 IM

Light fastness: 5-7 (EN ISO 105-B02)

Rubbing fastness: 4-5/4-5 (Wet/Dry) (EN ISO 105X12)

Pilling: 4-5 (EN-ISO 12945-2)

Environmental facts: EU Ecolabel, Oeko-Tex® Standard 100, 100% free of heavy metals, ISO 14001 certified company

Design: Cenk Kivrikoglu

Produced in: Lithuania

Cleaning: Professional dry cleaning (For further info follow Gabriel's cleaning guidelines - www.gabriel.dk)



26% rabatt ska dras av på angivna priser

OCEANIC (CAMIRA) - PRICE GROUP 3

Oceanic is made from 100 % post-consumer recycled polyester yarn where 90% are created from post-consumer plastic bottles diverted from landfill and 10% is upcycled marine plastic(from marine litter). It is a fabric born out of the SEAQUAL Initiative designed to combat marine plastic pollution and achieve a waste free environment. Oceanic has a two coloured diagonal structure with a matte surface and soft touch.

Composition: 100 % post-consumer recycled polyester, including 50% SEAQUAL yarn

Weight: 497 g/m² ±5%

Abrasion resistance: >100 000 Martindale (EN ISO 12947-2)

Flammability: BS EN 1021: 1-2 (Cigarette & match), BS 7176 Low, BS 7176 Medium Hazard with EnviroFlam5, CA TB 117-2013

Light fastness: 5 (EN ISO 105 - B02: 2013)

Rubbing fastness: 4/4 (Wet/Dry) (EN ISO 105X12)

Pilling: 4 (EN ISO 12945-2)

Environmental facts: EU Ecolabel, Oeko-Tex® Standard 100, Indoor Advantage™ "Gold", non metallic dyestuffs, ISO 14001 certified company.

Design: Camira Design Studio

Produced in: United Kingdom

Cleaning & disinfection: Washable at 60 °C and bleach cleanable (For further info follow Camira´s cleaning guidelines – www.camirafabrics.com)



STEP (GABRIEL) - PRICE GROUP 3

Step is unique in both texture and performance. With its delicate surface, Step is perceived as vivid and interesting. The texture with the fire-resistant Trevira CS yarn ensures that the fabric is suited for use in environments with high fire safety and durability requirements.

Composition: 100% Trevira CS

Weight: 336 g/m²

Composition: 100% Trevira cs

Abrasion resistance: 100 000 Martindale (EN ISO 12947-2)

Flammability: BS EN 1021: 1&2 (Cigarette & match), BS 5852 0&1 (Cigarette & match), BS 5852 Crib 5, CA TB 117-2013, MED Certificate IMO, Class Uno UNI 9175 Class 1 EMME, ÖNORM

Light fastness: 5-7 (EN ISO 105 - B02)

Rubbing fastness: 4-5/4-5 (Wet/Dry) (EN ISO 105X12)

Pilling: 4-5 (EN ISO 12945-2)

Environmental facts: EU Ecolabel, Oeko-Tex® Standard 100, 100% free of heavy metals, ISO 14001 certified company

Design: Inger Mosholt Nielsen

Produced in: Lithuania

Cleaning: Professional dry cleaning (For further info follow Gabriel's cleaning guidelines www.gabriel.dk)

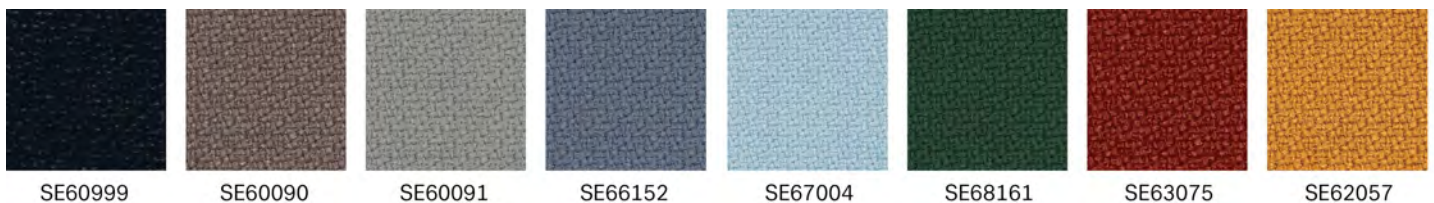

26% rabatt ska dras av på angivna priser

SYNERGY (CAMIRA) - PRICE GROUP 3

Epitomising natural simplicity, Synergy is a wool rich fabric which is at once both irresistibly soft and ultra-high performing. Delicately felted, with a beautifully relaxed drape, the understated aesthetics showcase the intriguing coloration of this considered textile.

Composition:

- 95% wool
- 5% polyamide
- **Weight:** 400 g/m²

Certificates:

- **Abrasion resistance:** 100000 Martindale cycles (BS-EN ISO 12947-2)
- **Pilling resistance:** 4 (BS-EN ISO 12945-2)
- **Flammability:** cigarette (BS-EN 1021-1)
- **Flammability:** match (BS-EN 1021-2)
- **Flammability:** (UNI 9175 Class 1IM)
- **Light fastness:** 5 (ISO 105-B02)
- **Maintenance:**
 - -vacuum regularly
 - -use dry-clean preparations
 - -do not bleach

Because of the fact that the fabric Synergy is composed of 95% natural fiber, each of the batches shows variations in shade, which may be visible in products of follow-up orders. Additionally, an inherent feature of all natural fibers is the tendency to delicate fabric pilling.

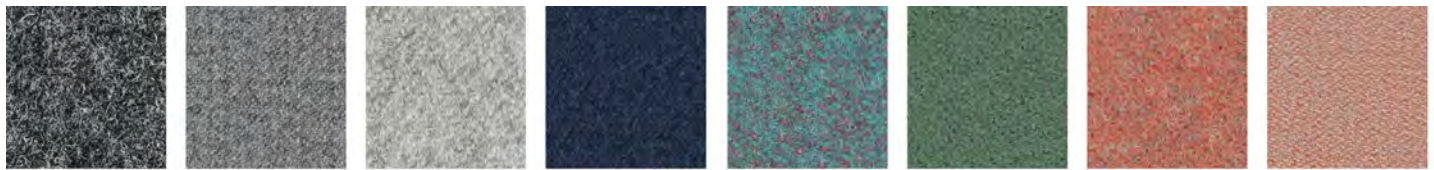

SGY017

SGY016

SGY008

SGY062

SGY056

SGY049

SGY073

SGY074

STEELCUT 3 (KVADRAT) - PRICE GROUP 4

Steelcut 3 is a unicoloured strong worsted wool and polyamide woven fabric, combining durability, soft touch and colour depth. The construction create a three-dimensional surface resembling small pyramids or steel points. Despite its complex weaving technique, it has a simple and precise expression.

Composition: 90% worsted new wool, 10% polyamide

Weight: 825 g/lm

Abrasion resistance: 100 000 Martindale (EN ISO 12947-2)

Flammability: BS EN 1021: 1-2 (Cigarette & match, CA TB 117-2013, BS 5852 Crib 5 (with treatment), BS 5852 part 1, IMO FTP Code 2010 Part 8, NF D 60 013, NFPA 260, UNI 9175 1IM, ÖNORM B1/Q1, AS/NZS 3837 Class 2, ASTM E84 Class A Unadhered, ASTM 84 Class B Adhered

Light fastness: 5 6 (EN ISO 105-B02)

Rubbing fastness: 3-5/4-5 (Wet/Dry) (EN ISO 105X12)

Pilling: 3-4 (EN ISO 12945-2)

Environmental facts: EU Ecolabel, 100% free of heavy metals, ISO 14001 certified company, GREENGUARD Gold

Design: Frans Dijkmeijer, Giulio Ridolfo (updated colourways)

Produced in: United Kingdom

Cleaning: Professional dry cleaning with tetrachloroethylene, normal process (For further info follow Kvadrat's cleaning guidelines - www.kvadrat.dk)

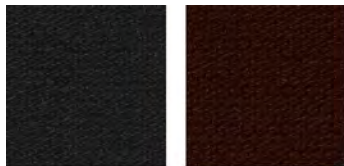

STT190

STT655

STEELCUT TRIO 3 (KVADRAT) - PRICE GROUP 4

Steelcut Trio 3 is a strong worsted wool and polyamide woven fabric, made with three different coloured yarns. The colours and the special weave create a three-dimensional surface where the colours seem to change depending on the angle of perspective. Like Steelcut 3, despite the complexity of the textile's innovative weave, it has a simple, precise expression.

Composition: 90% worsted new wool, 10% polyamide

Weight: 770 g/lm

Abrasion resistance: 100 000 Martindale (EN ISO 12947-2)

Flammability: BS EN 1021: 1-2 (Cigarette & match, CA TB 117-2013, . BS 5852 Crib 5 (with treatment), BS 5852 part 1, BS 5852 ignition source 3, IMO FTP Code 2010 Part 8, NF D 60 013, NFPA 260, UNI 9175 1IM, ÖNORM B1/Q1, AS/NZS 3837 Class 2, GB 50222 B1 with treatment (Chinese)

Light fastness: 6-7 (EN ISO 105-B02)

Rubbing fastness: 3-5/4-5 (Wet/Dry) (EN ISO 105X12)

Pilling: 4 (EN ISO 12945-2)

Environmental facts: EU Ecolabel, 100% free of heavy metals, ISO 14001 certified company, GREENGUARD Gold

Design: Frans Dijkmeijer, Giulio Ridolfo (updated colourways)

Produced in: United Kingdom

Cleaning: Professional dry cleaning with tetrachloroethylene, normal process (For further info follow Kvadrat's cleaning guidelines – www.kvadrat.dk)

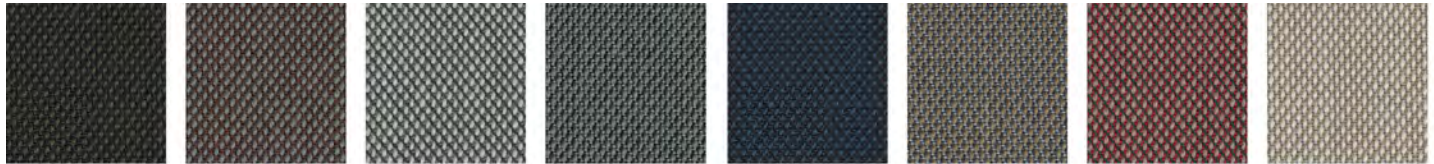

STT383

STT276

STT133

STT153

STT796

STT253

STT645

STT213

PALOMA SOFT (WOLLSDORF) - PRICE GROUP 6

High quality semi-aniline leather. All our standard colours from Paloma have a special finish adding a particular softness to the leather. Excellent friction and breathing properties. The surface may feature small scars and marks resulting from insect bites etc. These are proof of the natural origin of the product and are part of its character.

Flammability: BS EN 1021: 1-2 (Cigarette & match), BS 5852 Crib 5, IMO A.652 (16)

Light fastness: 6 (EN ISO 105-B02)

Rubbing: Wet 80/4 -Dry 2000/4 - Sweat 50/4 - ISO 11640

Finish-adhesion: 2.0 N/cm ISO 11644

Tear-strength: 20 N/mm DIN 53329- A

Environmental facts: Tanned without using chromium salts, BlueAngel, ECO2L-certificate, ISO 14001 certified company

Produced in: Austria

Animal Welfare: All hides are by-products from the meat and dairy industries, only use hides from healthy and uninjured animal. Following European standards as a minimum and the "Five Freedoms" of livestock as defined by FAWC (Farm Animal Welfare Council)

Cleaning: Follow the leather care guide from our supplier – www.wollsdorf.com

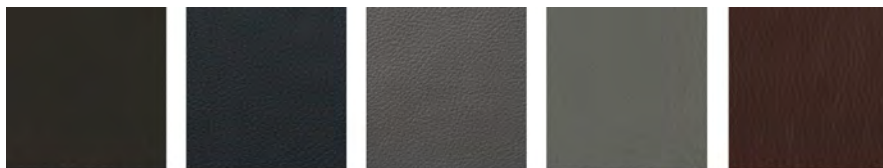

ATG56100

ATG55185

ATG55206

ATG55115

ATG55130

26% rabatt ska dras av på angivna priser

Fabrics and finishings

Mesh

Ariz

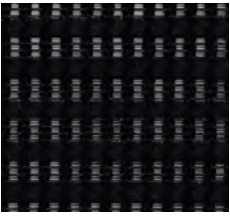

GZ-21

Mesh

Bit



Runner 60061

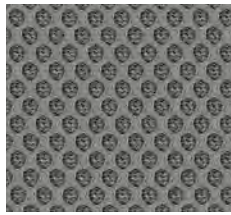

Runner 60011

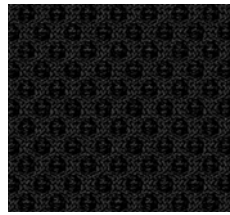

Runner 60999

Mesh

Zoo



Runner 60061

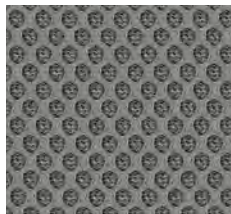

Runner 60011



Runner 60999

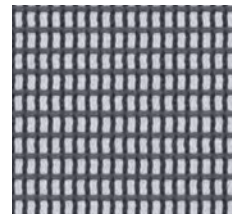

String 60118

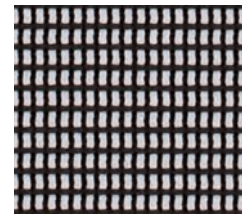

String 60999

Finishing colours in print may differ from real ones.

26% rabatt ska dras av på angivna priser

Fabrics and finishings

Plastics

Ariz

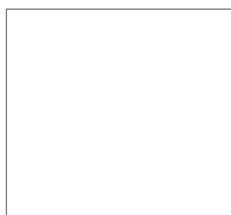

CODE 20



CODE 517

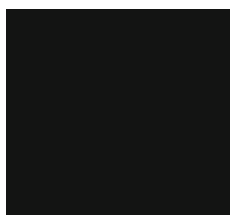

CODE 01



CODE 516



CODE 503



CODE 513



CODE 3020

Plastics

Ellie^{Pro}/ Trillo^{Pro}

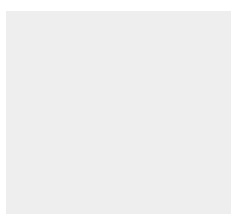

Light grey (RAL 7047)



Black

Plastics

Mickey

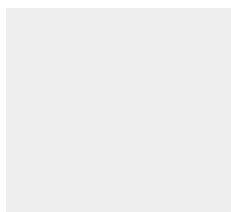

Light grey (RAL 7047)



Grey (RAL 7043)



Beige (RAL 7036)

Finishings colours in print may differ from real ones.

26% rabatt ska dras av på angivna priser

Fabrics and finishings

Plastics / frames

Zoo

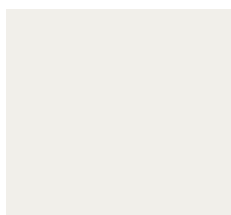

Light grey (NCS S 2500-N)



Grey (NCS S 6500-N)

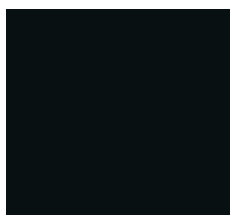

Black (RAL 9005)

Tempered glass

Chic Tables



G1 (Milky)

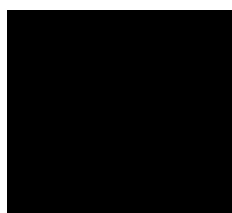

G2 (Black)



G3 (RAL 7044)



G4 (RAL 7042)

Kolor stelaży / Frame colours / Gestellfarben

Legenda / Legend / Legende:

- Nowość / New colour / Neue Farbe
- Bez zmian / No changes / Keine Änderungen

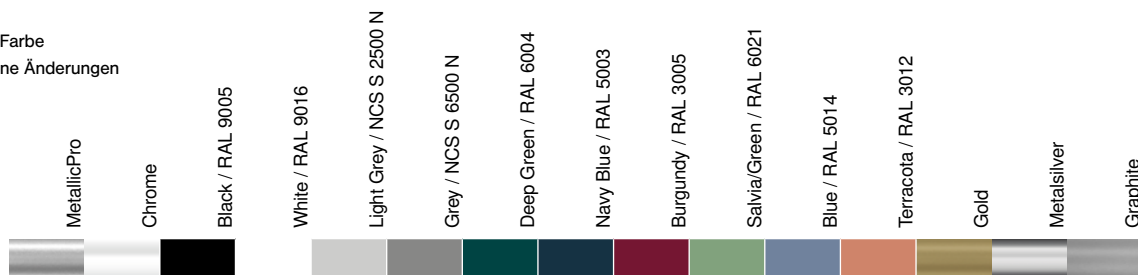

Model	Configuration	MetallicPro	Chrome	Black / RAL 9005	White / RAL 9016	Light Grey / NCS S 2500 N	Grey / NCS S 6500 N	Deep Green / RAL 6004	Navy Blue / RAL 5003	Burgundy / RAL 3005	Salvia/Green / RAL 6021	Blue / RAL 5014	Terracota / RAL 3012	Gold	Metalsilver	Graphite
Acos ^{Pro}	V, H, HC	●	○	○	●	●	●	●	●	●	●	●	●			
Arca	V, V PP	●	○	○	●											
Ariz	V, V 2P, CV	●	○	○	●	●	●	●	●	●	●	●	●			
Bit	H, V	●	○	○	●											
Chic	H	●	○	○	○	●	●	●	●	●	●	●	●	●		
Chic	CH	●	○	●	●	●	●	●	●	●	●	●	●			
Chic Lounge	V3, PV3, F	●	○	○	●	●	●	●	●	●	●	●	●	●		
Chic Tables	RR	●	○	○	●	●	●	●	●	●	●	●	●			
Chic Tables	RH, CS, CR	●	○	○	●	●	●	●	●	●	●	●	●	●		
Com	HC, HF, HS	●	○	○	●	●	●	●	●	●	●	●	●	●		
Com	H, H 2P, V, CV, V1, V1 2P, V2	●	○	○	●	●	●	●	●	●	●	●	●			
Ellie ^{Pro} (polished alu)	HST	●	○	○	○											○
Ellie ^{Pro}	V3	●		○	●	●	●							●	○	
Fan	H, HC, HS, V	●	○	○	●	●	●	●	●	●	●	●	●	●		
Fan	R	●	○	●	●	●	●	●	●	●	●	●	●			
MyTurn Sofa	H, V	●	○	○												
MyTurn Sofa Tables	H, V	●	○	○												
MyTurn	VN		○													
Normo	H, V, HS, HC	○		○	○	○	○	○	○	○	○	○	○			
Nu	H, V3	●	○	○	●	●	●	●	●	●	●	●	●	●		
Nu (polished alu)	HC	●	○	○	○											○
Nu	R	●	○	●	●	●	●	●	●	●	●	●	●			
October	-	●	○	○												
October Tables	-	●	○	○												
Revo Tables	-	○		○	○	●	●	○	○	○	○	○	○			
Seven	-	●		○	○	●	●	●	●	●	●	●	●			
SoftBox (polished alu)	-		○	○												
SoftBox Tables	-		○	○												
Sorriso	V	●	○	○												
Sun	H, V, H 2P, H 2PB	●	○	○												
Tables	SV, SH, SR	●	○	○	●	●	●	●	●	●	●	●	●			
Trillo ^{Pro} (polished alu)	HST	●	○	○	○											○
Vancouver Lite	H, V	●	○	○												
Wall In	-	●	○	○												
Xenon	H, V, H 2P, V 2P	●	○	○												
Xenon Net	H, V, H 2P, V 2P	●	○	○												
Zoo	H, H 2P, HC, HC 2P	●	○	○	●	○	○									

26% rabatt ska dras av på angivna priser

Kolory drewna i sklejk / Wood colours / Holzfarben

Legenda / Legend / Legende:

- Nowość / New colour / Neue Farbe
- Bez zmian / No changes / Keine Änderungen

	Sklejka bukowa / Stained beech / Holz (Schichtholz Buche)			Okleiny naturalne / Natural veneers / Beiztöne Holz				Okleiny naturalne barwione / Coloured natural veneers / Farben von Edeleurnier				
	H6	H12	H5	Ash (NA)	Beech (NB)	Oak (NO)	Walnut (NW)	White Ash CNA01	Black Ash CNA02	Deep Green Ash CNA05 (RAL 6004)	Navy Blue Ash CNA06 (RAL 5003)	Burgundy Ash CNA07 (RAL 3005)
Chic	○	○	○									
Chic Tables				●	●	●	●	●	●	●	●	●
Com	○	○	○	●		●	●	●	●	●	●	●
Ellie ^{Pro}	○	○	○									
Fan	○	○	○									
MyTurn Sofa Tables												
Nu	○	○	○									
October	○	○	○									
October Tables	○	○	○									
Revo Tables				○	○	○	○	○	○	○	○	○
SoftBox Tables												
Tables SH/SR												
Tables SW	○	○	○									
Wall In												

26% rabatt ska dras av på angivna priser

Kolory drewna i sklejk / Wood colours / Holzfarben

Legenda / Legend / Legende:

- Nowość / New colour / Neue Farbe
- Bez zmian / No changes / Keine Änderungen

	Okleiny naturalne modyfikowane / Natural modified veneers / Beiztöne Holz										Drewno (dąb) / Wood (Oak) / Holz (Buche)			
	HM10	HM11	HM12	HM20	HPL	White LW01 (RAL 9016)	Light Grey LW03 (NCS S 2500-N)	Grey LW04 (RAL 7037)	Black LW02 (RAL 9011)	Navy Blue LW06 (RAL 5003)	Light Burgundy LW07 (RAL 3004)	HO6	HO12	HO11
Chic														
Chic Tables														
Com						○	●	○	○	●	●			
Ellie ^{Pro}														
Fan												○	○	○
MyTurn Sofa Tables	○	○	○	○		●		●	●					
Nu														
October														
October Tables														
Revo Tables						○	●	●	○	○	○			
SoftBox Tables	○	○	○	○		○		○	○					
Tables SH/SR						○	●	○	○	●	●			
Tables SW												○	○	○
Wall In						○	●	○	○	●	●			

26% rabatt ska dras av på angivna priser

Kolory kubeków / Shell colours / Schalenfarbe

Legenda / Legend / Legende:

- Standardowy czas realizacji / Standard delivery time / Standardlieferzeit
- Wydłużony czas realizacji / Extended delivery time / Verlängerte Lieferzeit

Model	Plastics														Veneer shell		
	Poppy	Vanilla	Straw	Rose	Coral	Sky	Sea Green	Teal Blue	Forest	Misty Grey	Clay	Graphite	Graphite – recycled PP	Charcoal	Oak	Dark stained Oak	
Ana	●	●					○	●		●		●	●				
Noor 6050/6055	○	●	○	○	○	○	●	●	○	●	●	●		●	○		
Noor 6060/6065	○	●	○	○	○	○	●	●	○	●	●	●		●	○		
Noor 6070/6075	○	●	○	○	○	○	●	●	○	●	●	●		●	○		
Noor 6080/6085	○	●	○	○	○	○	●	●	○	●	●	●		●	○		
Noor Up 6090/6095	○	●	○	○	○	○	●	●	○	●	●	●		●	○		

Kolory stelaży / Frame colours / Gestellfarbe

Legenda / Legend / Legende:

- Standardowy czas realizacji / Standard delivery time / Standardlieferzeit
- Wydłużony czas realizacji / Extended delivery time / Verlängerte Lieferzeit

Model	Frames											Aluminium elements				Wood (Ash)			Aluminium elements for base 6080/6085	
	Lingon RAL 3000	Snow (White) RAL 9016	Canola	Rose	Aqua	Sea Green	Teal Blue	Forest	Misty Grey	Black RAL 9005	Metalsilver	Steelgrey	Polished Alu	White stained Ash	Stained Ash	Dark stained Ash	Black painted Aluminium frame	Polished Aluminium frame		
Ana	○	●				○	●		●	●	●						●			
Noor 6050/6055	○	○		○		●	●	○	○	●	●									
Noor 6060/6065	○	●	○	○	○	●	●	○	○	●	●									
Noor 6070/6075		○							●			○								
Noor 6080/6085														○	●	○	●	○		
Noor Up 6090/6095	○	●	○	○	○	●	●	○	○	●	●									

26% rabatt ska dras av på angivna priser

Kolory blatów / Table tops colours / Plattefarbe

Legenda / Legend / Legende:

- Standardowy czas realizacji / Standard delivery time / Standardlieferzeit
- Wydłużony czas realizacji / Extended delivery time / Verlängerte Lieferzeit

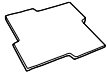

	HPL													Linoleum					Melamine	
	Polar White Mat Formica F2255	Folkstone Formica F7927	Sarum Grey Formica F2770	Diamond Black Formica F2253	Oak natural Formica F1079	Birch Formica F7921	Pale Ash Nat Formica F1004	Elegant Oak Nat Formica F5374	Refined Walnut Nat Formica F5872	Dark Ash Nat Formica F8575	Kashmir Mat Formica F0187	Oyster Grey Mat Formica F7929	Pumice Mat Formica F7858	Olive Forbo Desktop 4184	Smokey Blue Forbo Desktop 4179	Burgundy Forbo Desktop 4154	Iron Forbo Desktop 4178	Beech M3227		
Allround	●	●	○	○	○	○	○	○	○	○	○	○	○	○	○	○	○	●		
u-Connect	●	●	○	○	○	○	○	○	○	○	○	○	○	○	○	○	○	●		
Eminent	●	●	○	○	○	○	○	○	○	○	○	○	○	○	○	○	○	●		
Standard Folding table	●	●	○	○	○	○	○	○	○	○	○	○	○	○	○	○	○	●		

Kolory stelaży / Frame colours / Gestellfarbe

Legenda / Legend / Legende:

- Standardowy czas realizacji / Standard delivery time / Standardlieferzeit
- Wydłużony czas realizacji / Extended delivery time / Verlängerte Lieferzeit



	Snow RAL 9016	Misty Grey	Metalsilver	Steelgrey	Black RAL 9005/RAL9011	Polished aluminium
Allround	●	●	●	●	●	○
u-Connect	●	●	●	●	●	○
Eminent	●	●	●	●	●	○
Standard Folding table	○	●	●	●	●	○

Rozmiary blatów / Table top sizes / Plattenmaßen

Legenda / Legend / Legende:

- Standardowy czas realizacji / Standard delivery time / Standardlieferzeit
- Wydłużony czas realizacji / Extended delivery time / Verlängerte Lieferzeit
- Standard / Extended

cm	ø60	ø70	ø80	ø100	ø120	ø160	1/2 circle ø160	Ellipse 180 x 100	Trapezium 140x70x70x70, depth 60	80 x 80	90 x 60	120 x 45	120 x 60	120 x 70	120 x 80	120 x 90	140 x 60	140 x 70	140 x 80	160 x 70	160 x 80	180 x 70	180 x 80	180 x 90	
Allround	○	●	○	○	○			○		○				●	●			●	●			○	○	●	○
u-Connect													●	●	●			●	●	●	●	●	●	●	●
Eminent					○	○			○	○			●		●		○	●	●		●		●		○
Standard Folding table							○				●	●	●	●	●	●	●	●	●	●	●	●	○	●	○

Fabrics - Extended

Lead time 30-40 working days

- Legend: ● Possibility of making the product in the given upholstery
 ○ Possibility of making only the seat in the given upholstery
 □ No possibility of making the walls in the given upholstery
- ◇ Handle always in fabric Next
 - Impossibility of making a product in a given upholstery

	Camira											Gabriel										
	Blazer (PG 3)	Craggan Flax (PG 4)	Era (PG 3)	Gravity (PG 3)	Main Line Flax (PG 3)	Rivet (PG 3)	Nexus (PG 3)	Rivet (PG 3)	Urban (PG 3)	X2 (PG 3)	Breeze Fusion (PG 4)	Chilli (PG 3)	Comfort+ (PG 5)	Crisp (PG 3)	Cyber (PG 3)	Fame (PG 2)	Focus (PG 3)	Focus Melange (PG 3)	Go_Check (PG 3)	Focus Royal (PG 3)	Gaja Classic (PG 3)	
Ana	●	●	●	●	●	●	●	●	●	●	●	●	●	●	-	●	●	●	●	●	●	
Ariz	●	-	●	-	●	●	-	-	●	●	-	●	-	-	●	●	●	●	●	-	-	
Bit	●	-	●	-	●	●	-	-	●	●	-	●	-	-	●	●	●	●	●	-	-	
Chic	●	-	●	-	●	●	-	-	●	●	-	●	-	-	●	●	●	●	●	-	-	
Chic Lounge	●	-	●	-	●	●	-	-	●	●	-	●	-	-	●	●	●	●	●	-	-	
Com	●	-	●	-	●	●	-	-	●	●	-	●	-	-	●	●	●	●	●	-	-	
Ellie ^{Pro}	●	-	●	-	●	●	-	-	●	●	-	●	-	-	●	●	●	●	●	-	-	
Fan	●	-	●	-	●	●	-	-	●	●	-	●	-	-	●	●	●	●	●	-	-	
Mickey	●	-	●	-	●	●	-	-	●	●	-	●	-	-	●	●	●	●	●	-	-	
MyTurn Sofa	●	-	●	-	●	●	-	-	●	●	-	●	-	-	●	●	●	●	●	-	-	
Noor	●	●	●	●	●	●	●	●	●	●	●	●	●	●	●	●	●	●	●	●	●	
Noor F	●	-	-	-	●	-	●	-	-	●	-	●	-	-	●	●	●	●	●	●	●	
Normo	●	-	●	-	●	●	-	-	●	●	-	●	-	-	●	●	●	●	●	-	-	
Nu	●	-	●	-	●	●	-	-	●	●	-	●	-	-	●	●	●	●	●	-	-	
October	●	-	●	-	●	●	-	-	●	●	-	●	-	-	●	●	●	●	●	-	-	
Revo	●	-	●	-	●	●	-	-	●	●	-	●	-	-	●	●	●	●	●	-	-	
SoftBox	●	-	●	-	●	●	-	-	●	●	-	●	-	-	●	●	●	●	●	-	-	
Sorriso	●	-	●	-	●	●	-	-	●	●	-	●	-	-	●	●	●	●	●	-	-	
Trillo ^{Pro}	●	-	●	-	●	●	-	-	●	●	-	●	-	-	●	●	●	●	●	-	-	
Vancouver Lite	●	-	●	-	●	●	-	-	●	●	-	●	-	-	●	●	●	●	●	-	-	
Vancouver Oto	●	-	●	-	●	●	-	-	●	●	-	●	-	-	●	●	●	●	●	-	-	
Wall In	●	-	●	-	●	●	-	-	●	●	-	●	-	-	●	●	●	●	●	-	-	
Zoo	●	-	●	-	●	●	-	-	●	●	-	●	-	-	●	●	●	●	●	-	-	
Cushions	●	-	●	-	●	●	-	-	●	●	-	●	-	-	●	●	●	●	●	-	-	

26% rabatt ska dras av på angivna priser

Fabrics - Extended

Lead time 30-40 working days

Gaja C2C (PG 3)	Passion (PG 4)	Step Melange (PG 3)	GU											Kvadrat								
			Arndal (PG 4)	Bardal (PG 4)	Gandal + (PG 4)	Heidal (PG 4)	Hemsedal (PG 3)	Mandal (PG 4)	Morgedal (PG 4)	Setesdal (PG 4)	Sirdal (PG 4)	Suldal (PG 4)	Atlas (PG 3)	Canvas (PG 4)	Coda (PG 6)	Divina Melange (PG 5)	Divina (PG 5)	Divina MD(PG 5)	Flord 2 (PG 4)			
●	●	●	●	●	●	●	●	●	●	●	●	●	●	●	●	●	●	●	●	●	Ana	
-	-	●	-	-	-	-	-	-	-	-	-	-	●	●	-	●	●	-	-	-	Ariz	
-	-	●	-	-	-	-	-	-	-	-	-	-	●	●	-	●	●	-	-	-	Bit	
-	-	●	●	●	●	●	●	-	●	●	●	●	●	●	●	●	●	●	-	-	Chic	
-	-	●	●	●	●	●	●	-	●	●	●	●	●	●	●	-	-	●	-	-	Chic Lounge	
-	-	●	●	●	●	●	●	-	●	●	●	●	●	●	-	●	●	●	-	-	Com	
-	-	●	●	●	●	●	●	-	●	●	●	●	●	-	-	●	●	●	-	-	Ellie ^{Pro}	
-	-	●	●	●	●	●	●	-	●	●	●	●	●	●	●	●	●	●	-	-	Fan	
-	-	●	●	●	●	●	●	-	●	●	●	●	●	-	◇	◇	◇	●	-	-	Mickey	
-	-	●	●	●	●	●	●	-	●	●	●	●	●	●	●	●	●	●	-	-	MyTurn Sofa	
●	●	●	●	●	●	●	●	●	●	●	●	●	●	●	●	●	●	●	●	●	Noor	
●	-	●	●	●	-	-	●	-	-	-	-	-	-	-	●	●	●	●	●	●	Noor F	
-	-	●	●	●	●	●	●	-	●	●	●	●	●	●	●	●	●	●	-	-	Normo	
-	-	●	●	●	●	●	●	-	-	●	●	●	●	●	●	●	●	●	-	-	Nu	
-	-	●	-	-	-	-	-	-	-	-	-	-	●	●	●	●	●	-	-	-	October	
-	-	-	-	-	-	-	-	-	-	-	-	-	●	●	●	●	●	-	-	-	Revo	
-	-	●	●	●	●	●	●	-	●	●	●	●	●	●	●	●	●	●	-	-	SoftBox	
-	-	●	-	-	-	-	-	-	-	-	-	-	●	●	●	●	●	-	-	-	Sorriso	
-	-	●	-	-	-	-	-	-	-	-	-	-	●	-	-	●	●	-	-	-	Trillo ^{Pro}	
-	-	●	●	●	●	●	●	-	●	●	●	●	●	●	●	●	●	●	-	-	Vancouver Lite	
-	-	●	●	●	●	●	●	-	●	●	●	●	●	●	●	●	●	●	-	-	Vancouver Oto	
-	-	●	●	●	●	●	●	-	●	●	●	●	●	●	●	●	●	●	-	-	Wall In	
-	-	●	-	-	-	-	-	-	-	-	-	-	●	●	-	●	●	-	-	-	Zoo	
-	-	●	-	-	-	-	-	-	-	-	-	-	●	●	●	●	●	-	-	-	Cushions	

26% rabatt ska dras av på angivna priser

Fabrics - Extended

Lead time 30-40 working days

	Ana
	Ariz
	Bit
	Chic
	Chic Lounge
	Com
	Ellie ^{Pro}
	Fan
	Mickey
	MyTurn Sofa
	Noor
	Noor F
	Normo
	Nu
	October
	Revo
	SoftBox
	Sorriso
	Trillo ^{Pro}
	Vancouver Lite
	Vancouver Oto
	Wall In
	Zoo
	Cushions

26% rabatt ska dras av på angivna priser

MORGONDAGENS REUSE!

Kvalitet gör skillnad. I dagens resursslösande värld behövs produkter som håller och ger ett bestående värde den dag man inte behöver den längre. Därför uppfyller våra producenter branschens hårdaste miljö- och kvalitetskrav.



Addentity Interiör AB
Östra Rönneholmsvägen 5
211 47 Malmö

Telefon: 0733-335020
avropa@addentityinterior.se

Org.nummer: 556839-3416
Avtalsnumme: 23-3-5834-2022-008

26% rabatt ska dras av på angivna priser