

# *Karl Andersson & Söner*

2024

STATLIGT RAMAVTAL FÖR

## *Möbler och inredning*

Delområde: Möte och paus

DNR 23.3-5834-2022-009

Produktlista Nr: 1

**22%** RABATT SKA DRAS AV  
PÅ ANGIVNA PRISER



**SENAB**  
*Developing interiors*

# Vi hjälper dig att hitta rätt

Med olika utseende på prislistor från olika möbeltillverkare förstår vi att det kan vara tidskrävande att navigera i denna information. Vi på Senab är jobbar dagligen i dessa, så låt oss göra sökandet enkelt och bekvämt för dig, och hjälpa dig till rätt beslut. Här hittar du din kontaktperson på våra respektive kontor.

## STOCKHOLM

Peter Almgren  
076-533 50 43  
peter.almgren@senab.com  
Regeringsgatan 66  
111 39 Stockholm

## HÄLSINGLAND

Frida Engberg  
076-501 10 91  
frida.engberg@senab.com  
Karlsvägen 2  
828 25 Edsbyn

## SUNDSVALL

Jonas Westerlund  
076-502 02 04  
jonas.westerlund@senab.com  
Storgatan 4  
852 30 Sundsvall

## GÖTEBORG

Henrik Ericsson  
073-044 10 91  
henrik.ericsson@senab.com  
Fiskhamngatan 6C  
414 58 Göteborg

## GÄVLE/DALARNA

Cecilia Sjöblom  
076-501 10 93  
cecilia.sjoblom@senab.com  
Nygatan 28  
803 11 Gävle

## UMEÅ

Patrik Karlsson  
070-654 0066  
patrik.karlsson@senab.com  
Storgatan 41  
903 25 Umeå

## MALMÖ

Magdalena Andersson  
076-535 75 87  
magdalena.andersson@senab.com  
Fersens väg 3  
211 42 Malmö

## JÖNKÖPING

Pia Heldt  
076-533 51 57  
pia.heldt@senab.com  
Västra Storgatan 19A  
553 15 Jönköping

## UPPSALA

Linnéa Hempel  
076-195 39 86  
linnea.hempel@senab.com  
Stationsgatan 32 C  
753 40 Uppsala

**22%** RABATT SKA DRAS AV  
PÅ ANGIVNA PRISER

**SENAB**  
*Developing interiors*



KARL ANDERSSON & SÖNER  
SINCE 1898

CIRKAPRISLISTA SEK EXKL MOMS & FRAKT  
1 MARS 2024 - 28 FEBRUARI 2025

VERS.1

MÖTEN&PAUS  
SORTIMENT SOM UPPFYLLER MÖBELFAKTA

Karl Andersson & Söner Rosenålsvägen 8 SE-56134 Huskvarna, Sweden. +46(0)36-13 25 30. info@karl-andersson.se karl-andersson.se

SENAB

**22%** RABATT SKA DRAS AV PÅ ANGIVNA PRISER

## INNEHÅLL CONTENT

### BORD TABLE

55 Bat  
51 Buff  
31 Cap bord table  
54 Cap podium  
57 Eight  
30 Kanecct  
36 Locus  
52 Lollipop  
56 Mill  
57 Mopsy  
40 Pivå  
44 ponoq  
22 Press  
57 Puddle  
26 Rollo  
29 Study  
45 Tailor  
58 Terrane  
59 Trayo  
60 Trio  
47 Trippo  
34 Woodwork

### EXPONERINGSSYSTEM DISPLAY

9 1KM Display  
8 Arc  
8 Collar  
8 ELL  
17 Front fristående free-standing  
16 Front förvaring storage  
11 Front hylla shelf  
7 Front klädhängare coat hanger  
10 Front list ledge  
13 Front panel  
11 Front plant  
12 Front tavla board  
12 Part  
21 Ray  
19 Ridå  
20 Slope  
9 Svall

### KLÄDHÄNGARE COAT HANGER

6 Chess  
7 Front  
6 Knob  
6 Nest  
7 ponoq

### SITTMÖBLER SEATING

64 Colo Chair  
74 Facile  
66 Hygge  
76 Kamón  
63 Kaz  
70 Meander  
62 Milo  
72 Ondulé  
67 Sander Conference  
69 Sander Lounge  
61 Shell Pall Stool  
65 Shell Stol Chair

### PROVER SAMPLE

4 Prover Trä Laminat  
Samples Wood Laminat  
5 Tyg Läder Filt  
Fabric Leather Felt

Karl Andersson & Söner Besöndalagatan 6, SE-56134 Huskvarna, Sweden, +46(0)36 13 25 30, info@karl-andersson.se, karl-andersson.se  
Bankgiro 544-5408, Bank SHB 6641-710 660 758, VAT SE556043831801, IBAN SE50 6000 0000 0000 5509 6999, SWIFT HANDESS  
F-skattelövis

SENAB

22% RABATT SKA DRAS AV PÅ ANGIVNA PRISER



# INFORMATION

**Övrigt:** Vi förbehåller oss rätten till ändringar i kollektion, priser eller konstruktion. All information i denna prislista, inklusive måttuppgifter, material och priser kan bli ändrade utan föregående avisering. Tidigare prislister och försäljningsvillkor annulleras härmed.

**Utförande:** För varje artikel är standardutförande angivet i prislistan. Mått är i millimeter (mm). L=längd, B=bredd D=djup, H=höjd, ø=Diameter.

**Ytbehandling:** Ytbehandling är halvmatt syrahärdad lack. Deklarerade produkter enligt Möbelfakta är ytbehandling vattenbaserad lack. Avvikelse i utförande eller ytbehandling mot tillägg.

**Standard färger:** Lack (50) finns i följande standard färger svart (.58), gul(.62), röd(.67), grön(.74), snövit(.81), vit(.82), grå(.84), antracit(.86) uppge rätt färgnummer vid beställning se NCS-beteckningar på sid 4.

**Special färger:** Specialfärger enligt NCS kan erhållas mot ett tillägg av 2650 SEK per färg och order.

**Standardbets:** Standardbets är svart(.11), wenge(.12) snövit(.13), rödbrun(.14), grön(.15), röd(.16), blå(.17), brun(.18), grå(.19), valnöt(.20), valnöt (.21) Betsning sker på ek eller ask om inget annat anges. Uppge rätt färgnummer vid beställning se NCS-beteckningar på sid 4.

**Specialbets:** Vissa produkter kan erhållas i bets enligt förfrågan. Betsillägg tillkommer med 15% + startkostnad 2650 SEK.

**Vitpigment:** .25 vitpigment på ask och .26 vitpigment på ek. Pristillägg lika som standardbets.

**Läder:** Standardläder se sidan 5. För klädsel i insänt läder tillkommer extra klädselkostnad enligt offert.

**Tyg:** Standard tyger i respektive prisgrupp på sid. 5. Vid tyger med mönsterpassning samt vid avtagbar klädsel ökar tygätgången. Fråga oss om detaljerade uppgifter per modell. För insänt tyg är kostnad 790 SEK.

**Skötselråd:** Läs om hur du vårdar din möbel på [karl-andersson.se](http://karl-andersson.se) | [OM KA](#) | [SKÖTSELRÅD](#) | [VÅRDA DIN MÖBEL](#)

**Trä:** Trä är ett levande naturmaterial och har därför varierande teckningar och olika utseende. Detta är ett kvalitetsbegrepp och ej föremål för reklamationer.



MÖBELFAKTA

Produkter som innehar möbelfakta är: Arc, Cap, Collar, Colo Chair, Ell, Facile, Front list, Front panel, Front fristående, Hygge, Kamón Dinner, Kanecct, Kaz, Locus, Meander, Milo, Ondulé, Part, Pivå, Press med träben höjd 725mm, Ridå vägghängd, Ray, Rollo, Sander Lounge, Sander Conference, Shell pall, Shell stol, Slope, Study, Tailor, Woodwork. Dessa produkter är ytbehandlade med vattenbaserad lack. Om syrahärdad lack önskas ska detta framgå på order.

# INFORMATION

**Other terms:** We reserve the right to make changes to the range, to prices and to designs. All the information provided, including measurements, material and prices are approximate and can be subject to change without prior notice. This notice supersedes all earlier pricelists and conditions of sale.

**Finishes:** The pricelist shows the standard finish for each article. Dimension in millimeter (mm). L=length, B=width, D=depth, H=height, ø=Diameter.

**Surface treatment:** The standard surface finish is acid-hardened, semi-matt plastic lacquer. Products that holds Möbelfakta have waterbased treatment. Other finishes or surface treatment are available at a supplement.

**Standard colors:** Lacquer (50) is available in standard colors of black (58), yellow(62), red(67), green(74), snow white (81), white (82), anthracite(86), gray(84). Please state the correct color code when ordering. NCS-code see page 4.

**Special colors:** Special colors are available for a surcharge of SEK 2650 per color/per order.

**Standard stains:** Standardstain is black(.11), wenge(.12), snow white(.13.), red brown(.14), green(.15), red(.16), blue(.17), brown(.18), gray(.18), anthracite(.20), valnöt (.21). Stain is on oak or ash if nothing else says. Please state the correct color code when ordering. NCS-code see page 4.

**Special stains:** Certain products may be supplied in a stained finish on request. In such instances a surcharge is made equivalent to 15% of the order value + a start-up cost of SEK 2650.

**White glaze:** .26 white pigment on ash and .25 white pigment on oak. Extra cost same as standard stain.

**Leather:** Standard leather see page 5. Customers may also request a quotation for the cost of covering furniture in leather provided by the customer.

**Fabrics:** See the fabrics in the various price groups on page 5 For removable fabric and for pattern fitting, extra fabric is required. Contact us for detailed information. Cost for covering furniture with the customer's own fabric SEK 790. Make order of fabric samples directly from the producer.

**Furniture Care:** Read about how to take of your furniture at [karl-andersson.se](http://karl-andersson.se) | [ABOUT KA](#) | [FURNITURE CARE](#) | [TAKING CARE OF YOUR FURNITURE](#)

**Wood:** Wood is a living material with natural variations in hue and grain pattern. Any slight differences in appearance are an indication of genuine quality and do not form the basis of a cause for complaint.



MÖBELFAKTA

Products that holds Möbelfakta are Arc, Cap, Collar, Colo Chair, Ell, Facile, Front ledge, Front panel, Front free-standing, Hygge, Kanecct, Kamón Dinner, Kaz, Locus, Meander, Milo, Ondulé, Part, Pivå, Press wooden legs height 725mm, Ray, Ridå wall mounted, Rollo, Sander Lounge, Sander Conference, Shell stool, Shell chair, Slope, Study, Tailor, Woodwork. These products are standard surface waterbased. In case you want acid-hardened, semi-matt plastic lacquer please note on order.

# PROVER SAMPLES

Alla produkter finns ej i alla olika utförande. För mer information se under respektive produkt.  
Tänk även på att de tryckta proverna kan skilja sig i färg, struktur och nyans jämfört med levererad produkt.

All products are not available in all different versions. For more information please see under actual product.  
Also keep in mind that the printed samples can differ in color, texture and shades compared with delivered product.

## TRÅSLAG WOOD

Ytbehandling är klarlack i glansvärde 18, halvmatt. Alternativa ytbehandlingar olja, olja + lack kan erbjudas.  
Treated with clear lacquer in a no. 18 semi-matt finish. Other available finishes are oil or oil + lacquer.



.10 Ek Oak    .20 Björk Birch    .30 Ask Ash    .43 Körsbär Cherry

## STANDARDFÄRGER STANDARD COLORS

Glansvärde 35, halvblank. Alternativa färger kan erbjudas enligt NCS-skalan.  
Semi-gloss no. 35. Other colors are available in accordance with the NCS color system.



.62 Gul Yellow NCS S0580-Y    .67 Röd Red NCS 2070-Y80R    .74 Grön Green NCS S2010-G40Y    .81 Snövit Snow white NCS S0500-N    .82 Vit White NCS 0702-Y04R    .84 Grå Gray NCS S2500-N



.86 Antracit Anthracite NCS S7502-B    .58 Svart Black NCS S9500

## STANDARDBETSER STANDARD STAINS

Bets på ask eller ek om inget annat anges. Topplack är klarlack i glansvärde 18, halvmatt. Specialbetsar enligt insänt prov kan erbjudas.  
Stain on ash or oak if not otherwise specified. Top coat of clear lacquer in a no. 18 semi-matt finish. Special stains in accordance with samples sent to us are also available.



.11 Svart bets Black stain NCS S9500    .12 Wenge bets stain    .13 Snövit bets Snow white stain    .14 Rödbrun bets Red-brown stain    .15 Grön bets Green stain NCS S2010-G40Y    .16 Röd bets Red stain NCS S4050-Y80R



.17 Blå bets Blue stain NCS S5010-R90B    .18 Brun bets Brown stain NCS S8005-Y80R    .19 Grå bets Gray stain NCS S2500-N    .20 Antracit bets Anthracite stain NCS S7502-B    .21 Valnöt bets Walnut stain

## VITPIGMENT WHITE GLAZE

Vitpigment på ek eller ask om inget annat anges. Topplack är klarlack i glansvärde 18, halvmatt.  
White glaze on oak or ash if not otherwise specified. Top coat of clear lacquer in a no. 18 semi-matt finish.



.25 Vitpigment ask White glaze ash    .26 Vitpigment ek White glaze oak

## LAMINAT LAMINATE



.60 Vit White NCS S0502-G50Y    .61 Svart Black Fenix NTM 0720 Nero Ingo NCS S8500-N    .71 Ek Oak F5374 NAT    .72 Björk Birch F7555 MAT    .73 Ask Ash F8843 NAT

## DESKTOP

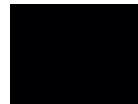

.90 Svart Black Forbo Nero col. 4023 NCS S9000-N

# TYGER LÄDER FABRIC LEATHER

Tyger Fabric				Läder Leather
Prisgrupp 1 Pricegroup	Prisgrupp 2 Pricegroup	Prisgrupp 3 Pricegroup	Prisgrupp 4 Pricegroup	Elmo Soft (EL)
Bond (GA)	Auckland (VE)	Barnum (NE)	Divina (KV)	99999 svart black
Creek* (VE)	Burton (VE)	Breeze Fusion (GA)	Divina MD (KV)	93068 brun brown
Easy (SV)	Blues CS II (NE)	Fiord 2 (KV)	Divina Melange (KV)	22030 natur natural
Europost 2 (GA)	Canvas 2 (KV)	Hallingdal 65 (KV)	Nobel (GA)	33004 cognac
Evolution (NE)	Capture (GA)	Intro CS (NE)	Moss (KV)	
Focus (GA)	Crisp (GA)	Memory 2 (KV)	Raas (KV)	
Focus Melange (GA)	Cyber (GA)	Morph (GA)	Recheck (KV)	
Harper (SV)	Energy (NE)	Steelcut Trio 3 (KV)	Safire (KV)	
Hello RE (SV)	Focus Royal (GA)	Tonus 4 (KV)	Foster (VE)	
Imola Plus* (NE)	Foster (VE)	Mood (GA)	Hallingdal 65 (KV)	
Jemo* (VE)	Generation (NE)	Morph (GA)	Lamu Recycled (VE)	
Gamut (VE)	Grain (GA)	Passion (GA)	Lani (VE)	
Leone* (VE)	Hero Heather (KV)	Re-wool (KV)	Memory 2 (KV)	
Liberty (NE)	Hestan (VE)	Rock (SV)	Poppy (SV)	
Lillehammer (NE)	Illusion konstläder* (NE)	Tonus 4 (KV)	Raas (KV)	
Malta* (VE)	Illusion full grain* (NE)		Rami (SV)	
Margrethe (NE)	Lamu Recycled (VE)		Revolt (SV)	
Pod CS (NE)	Naveli (KV)		Steelcut Trio 3 (KV)	
Puxx1&2* (BrdJ)	Passion (GA)		Wolin (VE)	
Rock CS (NE)	Pop CS (NE)			
Scott* (VE)	Poppy (SV)			
Slottsfjord (NE)	Rami (SV)			
Step (SV)	Remix 3 (KV)			
Step Melange (GA)	Re-wool (KV)			
Tone (SV)	Rocket (VE)			
Wooly (NE)	Select (GA)			
Wooly Plus (NE)	Wolin (VE)			

Fabrikat/Supplier  
 BrJ=Bröderna Jörgensen SV=Ludvig Svensson  
 GA=Gabriel VE=Vescom  
 KV=Kvadrat EL=Elmo Leather  
 NE=Nevotex \*=artificial leather

## FILT FELT

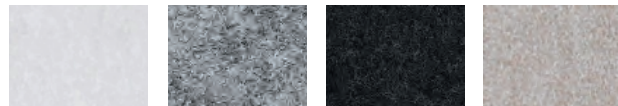

Offwhite  
Press  
Slope

Ljusgrå Light grey  
Ondulé  
Press  
Ridå  
Slope

Antracit Anthracite  
Ondulé  
Press  
Ridå  
Slope

Beige  
Ondulé



Stol Chair COLO CHAIR | Bord Table LOCUS | Soffa Sofa MEANDER | Tidskriftsställ Magazine shelf FRONT LIST LEDGE



Stol Chair SANDER CONFERENCE | Bord Table PIVÅ | Rumsavdelare Room divider RAY



Stol Chair SANDER CONFERENCE | Bord Table PRESS | Soffbord Sofa Table TRAYO | Hylla Shelf TRIPPO HYLLA

# SENAB

**22% RABATT SKA DRAS AV PÅ ANGIVNA PRISER**

# CHESS Malin Lundmark 2010

Klädhängare. Vägghängd. Massiv trä.  
Coat hanger. Wall mounted. Solid wood.



CSK kung king  
CSQ drottning queen  
CSP bonde pawn

## Chess SEK

Artno	Djup Depth mm	Diam mm	.50s Svart Black .50v Vit White	Vikt Weight kilos
CSK	118	100	520	0,5
CSQ	138	100	520	0,5
CSP	105	92	520	0,5

# KNOB Patrik Hansson 2010

Klädhängare. Vägghängd.  
Coat hanger. Wall mounted.



KN1 Massiv trä. 4-pack.  
Solid wood. Set of 4pcs.  
KNDS Dörrstopp svart gummi. 4-pack.  
Door stop black rubber. Set of 4pcs.

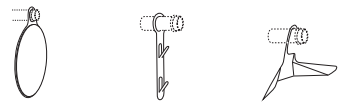

KNS Spegel metall.  
Mirror metal.  
KNH2 Krokar metall.  
Coat hook metal.  
KNG Galge metall.  
Coat hanger metal.

## Knob SEK

Artno	Djup Depth mm	Bredd Width mm	Höjd Height mm	Diam mm	s = Svart Black v = Vit White	Vikt Weight kilos
KN1.30	95			46	750	0,5
KNDS					80	
KNS1			295	240	540	0,5
KNH2			225		360	0,5
KNG1		430	140		480	0,5

# NEST Gabriella Gustafson Mattias Ståhlbom 2007

Klädhängare. Massiv trä. Coat hanger. Solid wood.

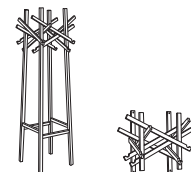

NEG1 golv / floor  
NEV1 vägg / wall

## Nest SEK

## Extra SEK

Artno	Bredd Width mm	Djup Depth mm	Höjd Height mm	.10 ek oak .20 björk birch .50 lack color	Standardbets, Vitpigment på ek Standard stain White glazed on oak	Vikt Weight kilos	Volym Volume
NEG1	500	500	1750	9720	+1450	16	0,73
NEV1	600	300	600	6670	+1000	6	0,2



**Klädhängare.**  
Vägghängd. Kompaktlaminat.

**Coat rack**  
Wall model. Compact laminate.

Artno

Vägghängd Wall mounted



PO12



PO25



PO50



PO75



PO100

**ponoq SEK**

Artno	Bredd Width mm	Djup Depth mm	Höjd Height mm	UTSIDA/insida .60 VIT/svart .61 SVART/vit	OUTSIDE/inside WHITE/black BLACK/white	Vikt Weight kilos	Volym Volume
Vägghängd Wall mounted							
PO12	124	16/50	140	1160		0,5	0,001
PO25	248	16/50	140	1670		1	0,002
PO50	498	16/50	140	2400		2	0,01
PO75	744	16/50	140	3630		3	0,02
PO100	996	16/50	140	4100		4	0,03

## FRONT KLÄDHÄNGARE COAT HANGER Skala Design 2004

**Front Klädhängare.** Massiv trä. Hängare av massiv wenge. Skruvas upp i vägg. Specialmått och andra utförande efter förfrågan. Vid beställning ange artikelnummer och utförande på trälist.

**Front Coat hanger.** Solid wood. Hooks in solid wenge. Secured directly to the wall. Special sizes and other finishes upon request.. Vid beställning ange artikelnummer och utförande på trälist.

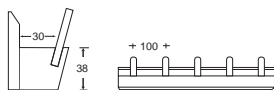

FR4 25



FR4 50



FR4 100



FR4 150



FR4 200

**Front coat hanger SEK**

**Extra SEK**

Artno	Bredd Width mm	Djup Depth mm	Höjd Height mm	.10 ek oak .20 björk birch	.50 Lack Color	Standardbets på ek Standard stain on oak Vitpigment ek White glazed oak	Vikt Weight kilos	Volym Volume
<b>Klädhängare Coat hanger</b>								
FR4 25 Tre hängare Three hangers	250	60	75	1910	2230	+180	1	0,01
FR4 50 Fem hängare Five hangers	500	60	75	2260	2650	+220	1	0,02
FR4 100 Tio hängare Ten hangers	1000	60	75	3550	4090	+360	2	0,03
FR4 150 Femton hängare Fifteen hangers	1500	60	75	4880	5590	+490	3	0,04
FR4 200 Tjugo hängare Twenty hangers	2000	60	75	6130	7070	+610	4	0,05

## ELL Lasse Pettersson 2021

### Tidskrifts- och broschyrförvaring.

Ram massivträ. Klarglas 6mm. Klarlack.Väggmonterad.

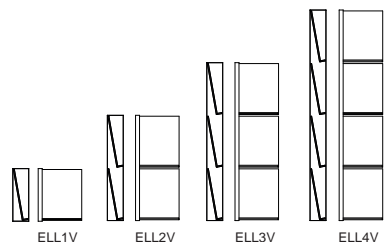

MÖBELFAKTA

### Magazine and brochure storage.

Solid wood. Clear glass 6mm. Clear lacquer. Wall mounted.

Artno	Bredd Width mm	Djup Depth mm	Höjd Height mm	ELL SEK		Extra SEK		
				.10 ek oak .20 björk birch .30 ask ash	.50 lack color	Standardbets på ask Standard stain on ash	Vikt Weight kilos	Volym Volume
ELL1V	275	100	330	2720	2920	+400	4	0,02
ELL2V	275	100	660	4720	5010	+710	8	0,04
ELL3V	275	100	990	6930	7470	+1040	10	0,05
ELL4V	275	100	1320	8930	9320	+1340	14	0,06

## COLLAR Louise Hederström 2011

### Tidskrifts- och broschyrförvaring.

Fanerad MDF. Väggmonterad.

COT11011 har fem flyttbara avdelare vilket ger fyra fack.

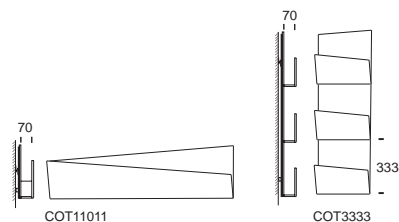

MÖBELFAKTA

### Magazine and brochure storage.

Veneerad MDF. Wall mounted

COT11011 has five adjustable dividers, get four sections.

Artno	Bredd Width mm	Djup Depth mm	Höjd Height mm	Collar SEK		Extra SEK		
				.10 ek oak .20 björk birch .30 ask ash	.50 lack color	Standardbets på ask Standard stain on ash	Vikt Weight kilos	Volym Volume
COT11011	1128	107	316	4080	3550	+610	8	0,08
COT3333	355	107	1029	5750	5000	+870	9	0,08

## ARC Sanna Lindström 2019

### Tidskrifts- och broschyrförvaring.

Ram massivträ. Front i fanerad plywood. Rygg fanerad MDF. Väggmonterad.

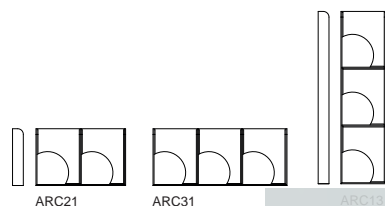

MÖBELFAKTA

### Magazine and brochure storage.

Frame in solid wood. Front in veneered plywood. Back veneered MDF. Wall mounted.

Artno	Bredd Width mm	Djup Depth mm	Höjd Height mm	Fack Invändigt mått Partition nternal dimension W/D/H	Arc SEK		Extra SEK		
					.10 ek oak .20 björk birch .30 ask ash	.50 lack color	Standardbets på ask Standard stain on ash	Vikt Weight kilos	Volym Volume
ARC21	540	77	342	249/53/330	4450	4310	+670	6	0,03
ARC31	807	77	342	249/53/330	5310	5110	+800	7	0,04
ARC13	273	77	1038	249/53/330	5510	5340	+820	7	0,04

SENAB

22% RABATT SKA DRAS AV PÅ ANGIVNA PRISER



KARL ANDERSSON & SÖNER Cirkprislista 2024 Vers.1

# SVALL Cecilia Cronelid 2016

## Tidskrifts- och Broschyrförvaring.

Svall finns som horisontell och vertikal modell.  
Massiv trä. Klarlack. Upphängning med dolda nyckelhålsbeslag.

## Magazine and brochure storage.

Svall is available as a horizontal and vertical model.  
Solid wood. Clear lacquer.  
Secures to the wall with concealed brackets.

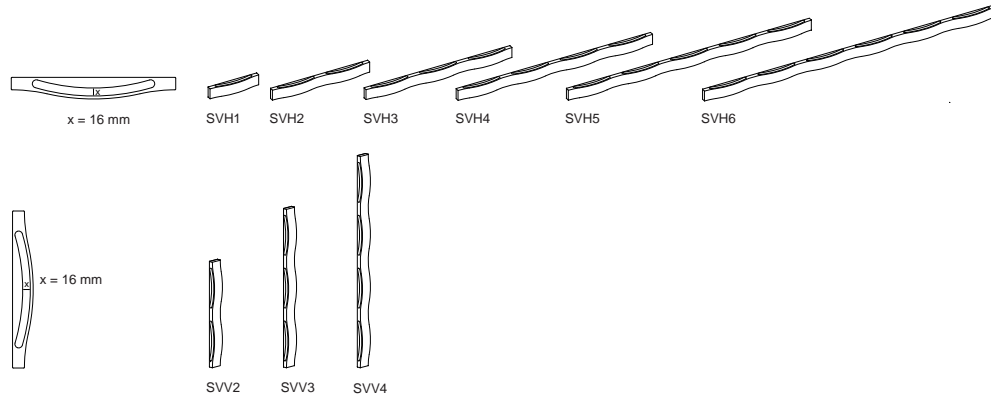

Artno	Bredd Width mm	Djup Depth mm	Höjd Height mm	Svall SEK		Extra SEK	
				.10 ek oak .30 ask ash .50 lack color	Standardbets på ask Standard stain on ash	Vikt Weight kilos	Volym Volume
<b>Horisontell Horizontally</b>							
SVH1	330	43	70	1420	+210	1	0,01
SVH2	660	43	70	1770	+250	2	0,01
SVH3	990	43	70	2190	+340	3	0,01
SVH4	1320	43	70	2590	+390	4	0,01
SVH5	1650	43	70	3180	+480	5	0,01
SVH6	1980	43	70	3780	+560	6	0,02
<b>Vertikal Vertical</b>							
SVV2	70	43	660	1770	+250	2	0,1
SVV3	70	43	990	2190	+340	3	0,1
SVV4	70	43	1320	2590	+390	4	0,1

# 1KM DISPLAY Kristofer Jonsson Fanny Jiseborn, white 2016

## Förvaring.

1KM Display en förvaring till sovrum, kök, kontor, hall mm. Vägghängd i massiv trä. Klarlack. Skruvas upp i vägg.

## Storage.

1KM Display a storage for bedrooms, kitchen, office, hall etc. Wall mounted. Solid wood clear lacquer. Screwed up into the wall.

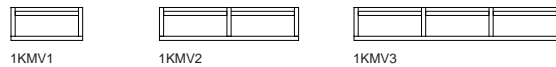
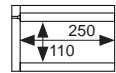

## Kopplingssektioner Connecting sections

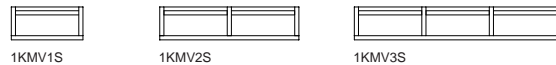

## Tillbehör Accessories

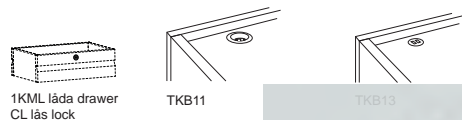

## 1KM Display SEK

## Extra SEK

Artno	Bredd Width mm	Djup Depth mm	Höjd Height mm	.10 ek oak .30 ask ash	.50 Lack Color	Standardbets på ask Standard stain on ash	Vikt Weight kilos	Volym Volume
1KMV1	379	272	174	5280	3760	+780	8	0,03
1KMV2	736	272	174	8010	5380	+1200	14	0,05
1KMV3	1093	272	174	10750	7090	+1610	18	0,09
<b>Kopplingssektioner Connecting sections</b>								
1KMV1S start	379	272	174	5280	3760	+780	8	0,03
1KMV2S start	736	272	174	8010	5380	+1200	14	0,05
1KMV3S start	1093	272	174	10750	7090	+1610	18	0,09
1KMV3M mellan middle	1071	272	174	9970	6580	+1490	17	0,08
1KMV3E end	1093	272	174	9970	6580	+1490	17	0,08
<b>Tillbehör Accessories</b>								
1KML låda drawer. invändigt/internal D218	332	250	107	2170	2170	+340	1,3	
CL lås förnicklat lock nickelplated				950				
TKB11 Powerdot Mini diam 57mm. 1 eluttag, 1,5m kabel. Svart. Placeras på hyllans ovansida. Gäller för SE,NO,DK,DK,FIN,DE,NL. Powerdot Mini diam 57mm. 1 electrical outlet.1,5m cable. Black. Placed on the top of the shelf. For SE,NO,DK,DK,FIN,DE,NL.				750	svart black			
TKB13 Powerdot Micro diam 35mm. 1xUSB A, 1xUSB C, 1,5m kabel. Svart. Placeras på hyllans ovansida. Gäller för SE,NO,DK,DK,FIN,DE,NL. Powerdot Micro diam 35mm. 1xUSB A, 1xUSB C. 1,5m cable. Black. Placed on the top of the shelf. For SE,NO,DK,DK,FIN,DE,NL.				1140	svart black			

# FRONT LIST LEDGE

Skala Design 2004



**Front List.** Massiv trä. Skruvas upp i vägg. Härdat klarglas som standard, vilket sätts i skåran av listen. Plexi finns mot tillägg och ska anges vid beställning. Andra träslag och färger än standard begär offert.

Vid beställning ange artikelnummer, utförande och höjd på glas.

**Speciallängd: Pris tag närmast övre längd +700 SEK.**

**Front ledge.** Solid wood. All sizes are secured directly to the wall. As standard tempered clear glass which inserted in the groove of the ledge. Plexi as extra cost and need to be state when ordering Other wood or colors upon request.

State when ordering: article number, finish and height of glass.

**Special lengths: Take price of next length +700 SEK**

Artno

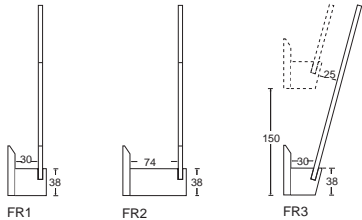

FR1

FR2

FR3



FR1 = D54



FR2 = D98



FR3

Tillbehör Accessories



FRAV 1 Avdelare Divider  
FRAV 2 Avdelare Divider to FR2 to FR1, FR3

Artno	Bredd Width mm	Djup Depth mm	Höjd Height mm	Klarglas höjd Clear glass height mm	Front List SEK		Extra SEK					
					.10 ek oak .20 björk birch	.50 Lack Color	Standardbets på ek Standard stain on oak	Plexi glas FRP	Gelelim till glas Gele glue for glass 3gr/tube FRLIM	Vikt Weight kilos	Volym Volume	
<b>Rak list Straight ledge D54</b>												
FR1 25	250	54	70	32/150/230	1540	1770	+160	+240	+150	1/1/2	0,01	
FR1 50	500	54	70	32/150/230	1880	2190	+180	+350	+150	1/2/3	0,01	
FR1 100	1000	54	70	32/150/230	2730	3140	+270	+490	+150	2/4/6	0,01/0,01/0,02	
FR1 150	1500	54	70	32/150/230	3570	4110	+360	+690	+150	3/6/9	0,01/0,01/0,02	
FR1 200	2000	54	70	32/150/230	4600	5310	+460	+860	+150	4/9/11	0,01/0,02/0,03	
<b>Rak list Straight ledge D98</b>												
FR2 25	250	98	70	32/150/230	1800	2130	+180	+240	+150	2/2/3	0,01/0,01/0,02	
FR2 50	500	98	70	32/150/230	2180	2490	+220	+350	+150	2/3/4	0,01/0,01/0,02	
FR2 100	1000	98	70	32/150/230	3290	3760	+340	+490	+150	3/5/7	0,01/0,01/0,03	
FR2 150	1500	98	70	32/150/230	4370	5020	+420	+690	+150	4/7/10	0,01/0,02/0,04	
FR2 200	2000	98	70	32/150/230	5610	6430	+560	+860	+150	5/10/12	0,02/0,03/0,05	
<b>Snedställd list Sloping ledge</b>												
FR3 25	250	54/105	70	150/230	1540	1770	+160	+240	+150	1/2	0,01	
FR3 50	500	54/105	70	150/230	1880	2190	+180	+350	+150	2/3	0,01	
FR3 100	1000	54/105	70	150/230	2730	3140	+270	+490	+150	4/6	0,01/0,02	
FR3 150	1500	54/105	70	150/230	3570	4110	+360	+690	+150	6/9	0,01/0,02	
FR3 200	2000	54/105	70	150/230	4600	5310	+460	+860	+150	9/11	0,02/0,03	
<b>Tillbehör Accessories Avdelare Dividers</b>												
FRAV1	12	44	38		150	150	+10					
FRAV2	12	88	38		160	160	+10					



# FRONT HYLLA SHELF Skala Design 2012

Front Hylla. Massiv trä. Skruvas upp i vägg.  
Samtliga hyllor skruvas rakt in i vägg, djup 250 mm förstärks även med dold konsol. Andra träslag och färger än standard begär offert.

Vid beställning ange artikelnummer och utförande.

**Speciallängd: Pris tag närmast övre längd +700 SEK.**

Front shelf. Solid wood. All sizes are secured directly to the wall. The 250 mm deep shelf is reinforced with a hidden bracket. Other wood or colors upon request.

State when ordering: article number and finish.

**Special lengths: Take price of next length +700 SEK**

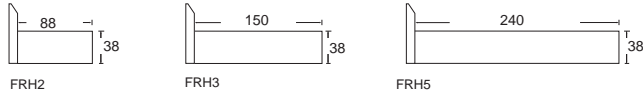

Artno	Maxvikt per hylla Max load per shelf kilos	Bredd Width mm	Djup Depth mm	Höjd Height mm	Front Hylla SEK		Extra SEK		Vikt Weight kilos	Volym Volume
					.10 ek oak .20 björk birch	.50 Lack Color	Standardbets på ek Standard stain on oak	Vitpigment ek White glazed oak		
<b>Hylla Shelf D98</b>										
FRH2 25	8	250	98/88	70	1640	1860	+160		2	0,01
FRH2 50	10	500	98/88	70	2060	2320	+210		2	0,01
FRH2 100	15	1000	98/88	70	3110	3550	+320		3	0,01
FRH2 150	20	1500	98/88	70	4090	4690	+400		4	0,01
FRH2 200	25	200	98/88	70	5420	6250	+540		5	0,02
<b>Hylla Shelf D160</b>										
FRH3 25	8	250	160/150	70	2170	2490	+210		2	0,01
FRH3 50	10	500	160/150	70	2730	3160	+270		3	0,01
FRH3 100	15	1000	160/150	70	3920	4490	+390		6	0,01
FRH3 150	20	1500	160/150	70	4940	5680	+510		9	0,02
FRH3 200	25	2000	160/150	70	6390	7340	+640		12	0,03
<b>Hylla Shelf D250</b>										
FRH5 25	10	250	250/240	70	2720	3140	+270		3	0,01
FRH5 50	20	500	250/240	70	3430	3950	+350		5	0,01
FRH5 100	30	1000	250/240	70	4850	5590	+490		8	0,02
FRH5 150	40	1500	250/240	70	6370	7320	+640		10	0,03
FRH5 200	50	2000	250/240	70	7990	9180	+800		15	0,04

# FRONT PLANT Skala Design 2009

Front Plant. En kombination av list och glaslåda (L500mm) för exempelvis växter. List massiv trä. Skruvas upp i vägg. Glaslåda sätts i skåran av listen.

Andra träslag och färger än standard begär offert.

Vid beställning ange artikelnummer, utförande på list och glaslåda.

Front Plant. A combination of a wood ledge and glass box (L500mm) for plants. Ledge in solid wood. Secured directly to the wall. Glass box is inserted in the groove of the ledge. Other wood or colors upon request.

State when ordering: article number and finish of ledge and glass box.

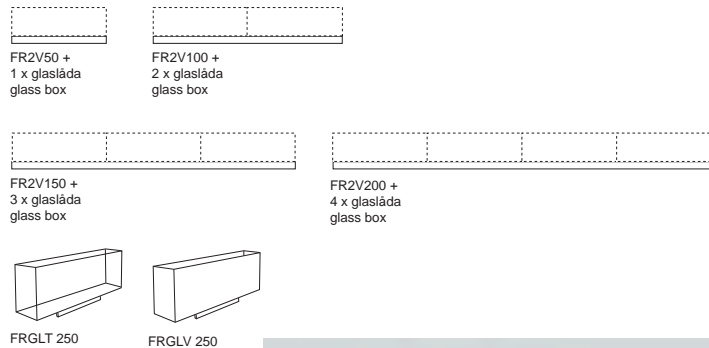

Artno	Bredd Width mm	Djup Depth mm	Höjd Height mm	Front Plant SEK		Extra SEK		Vikt Weight kilos	Volym Volume
				.10 ek oak .20 björk birch	.50 Lack Color	Standardbets på ek Standard stain on oak	Vitpigment ek White glazed oak		
<b>Vägglist Wall ledge</b>									
FR2V 50	500	98	38/70	2120	2390	+210		2	0,01
FR2V 100	1000	98	38/70	3180	3660	+320		4	0,01
FR2V 150	1500	98	38/70	4240	4900	+410		6	0,01
FR2V 200	2000	98	38/70	5530	6330	+550		9	0,02
<b>Glaslåda Glass box</b>									
FRGLT 250 Transparent	500	88	150	2240 transparent				5	
FRGLV 250 Vit White	500	88	150	2600 vit white				5	

# FRONT TAVLA BOARD Skala Design 2007

Front tavla, används som skylt eller där du snabbt kan byta papper för olika meddelande, fotografier eller vill exponera en affisch. List och glas har tunnare dimensioner än övriga Front. Front tavla består av liggande och stående A4 och A3 som skruvas direkt på vägg. Alternativt är ett antal liggande och stående A4 som är monterat på en träpanel. På ryggen finns ett grepp som gör det enkelt att snabbt byta papper. Affisch tavla för affischstorlek 700x500 respektive 1000x700mm. Panel och affischtavla hängs på vägg med metallist. List i massivt trä och rygg i MDF av faner. Ytbehandling klarlack. Härdat klarglas som standard. Mot tillägg finns plexiglas. Specialmått och andra utförande efter förfrågan.

Front board is a wall-mounted board for use as the backing for a sign or for displaying messages and changing them quickly and easily. Front display boards are available in A4 and A3 portrait and landscape formats, secured directly to the wall. The ledge and glass are slightly thinner than in the rest of the Front range. Alternatively, a number of landscape and portrait A4 which is mounted on a wood panel.

On the back there is a handle which makes it easy to change document. Billboard for poster-size 700x500 or 1000x700mm. Panel and billboard is mounted on the wall with a metal suspension strip. Ledge in solid wood and back in MDF. Finish clear lacquer. Tempered clear glass as standard and plexi glass upon request. Special sizes and other finishes upon request.

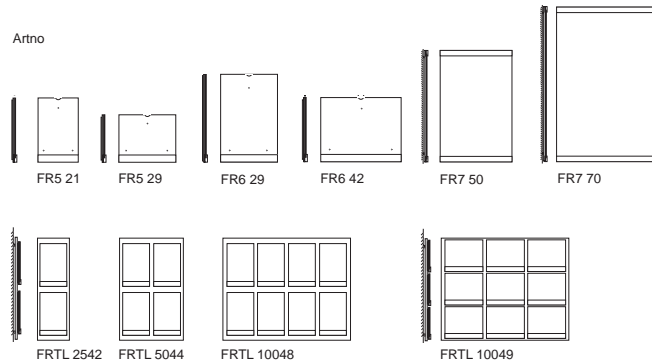

Artno	Bredd Width mm	Djup Depth mm	Höjd Height mm	Inv D Internal	Front Tavla Board SEK		Extra SEK			
					.10 ek oak .20 björk birch .50 lack color	Standardbets på ek Standard stain on oak	Plexi glas FRP	Vikt Weight kilos	Volym Volume	
FR5 21	210	27	335	2	1190	+130	+240	2	0,002	
FR5 29	297	27	248	2	1190	+130	+240	2	0,003	
FR6 29	297	27	458	2	1540	+160	+340	4	0,005	
FR6 42	420	27	335	2	1540	+160	+340	4	0,005	
<b>Affisch Poster</b>										
FR7 50	500	38	776	2	2820	+290	+460	9	0,03	
FR7 70	700	38	1076	2	4510	+430	+690	17	0,08	
<b>Panel</b>										
FRTL 2542	250	55	800	2	4890	+490	+510	7	0,03	
FRTL 5044	500	55	800	2	7910	+780	+1000	13	0,05	
FRTL 10048	1000	55	800	2	13700	+1380	+1990	26	0,12	
FRTL 10049	1000	55	800	2	14890	+1490	+2240	28	0,12	

# PART PetterssonRudberg 2019

Hyllan skapades under en geometrisk skisslek. Vänster- och högerhylla. Den tillverkas i massivträ i ek, ask och standardbets på ask, vitpigmenterad ek eller ask. Hyllan i standardfärg tillverkas i MDF. Hyllan skruvas upp på vägg.

Part shelf owes its origins to an exercise in geometric sketching. The shelf is available as a right- and left-hand unit. It is available in solid oak or ash, in standard stains on ash and in white-glazed oak or ash. The shelf in standard colours is made of MDF. Part is anchored to the wall with screws.

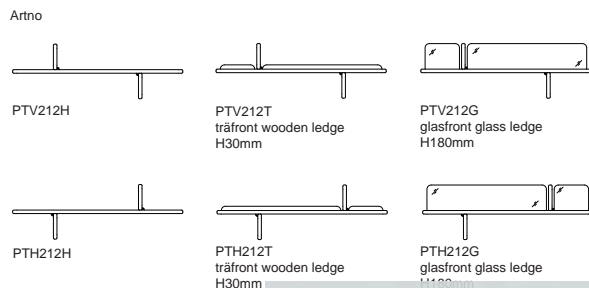

Artno	Bredd Width mm	Djup/Innerdjup Depth/Internal mm	Höjd Height mm	Part SEK		Extra SEK		
				.10 ek oak .30 ask ash	.50 Lack Color	Standardbets på ask Standard stain on ash Vitpigmenterad ek, ask White glazed oak ash	Vikt brutto Weight gross kilos	Volym Volume
PTV212H	1200	120	385	3760	3630	+560	6	0,08
PTV212T	1200	120/100	385	5590	5420	+560	6	0,08
PTV212G	1200	120/100	385	6020	5880	+560	7	0,08
PTH212H	1200	120	385	3760	3630	+560	6	0,08
PTH212T	1200	120/100	385	5590	5420	+560	6	0,08
PTH212G	1200	120/100	385	6020	5880	+560	7	0,08

# FRONT PANEL Skala Design 2007



Front panel används som tidskrifts-, broschyrställ, spegel, anslagstavla, skrivtavla eller en kombination av dessa. Beklädnad av rygg finns att välja mellan raka eller vinklade lister, magnetisk whiteboard inklusive ett antal magneter, Bulletin Board 2204, klädd i tyg Europost från Gabriel och spegel. Specialmått och andra utförande efter förfrågan.

Panelen hängs på vägg med metallist. Listerna i massivt trä och rygg i MDF av faner. Ytbehandling klarlack. Hårdat klarglas i höjderna 32, 150 (=A5) or 230 (=A4) mm. Som tillägg finns plexiglas. Istället för glas till magnetisk whiteboard eller anslagstavla kan man välja 15 mm hög träavslut. Tillbehör: Avdelare i massiv trä som sätts på glaset för indelning i fack. Extra magneter till whiteboard.

**Rygg**  
 FRB = Bulletin Board col 2204 (kantlist endast i vit, svart, ek, björk)  
 FRK = Klädd i tyg Europost  
 FRW = Magnetic Whiteboard (kantlist endast i vit, svart , ek eller björk)  
 FRS = Spegel

Front panel is a magazine rack, a brochure stand, a mirror, a writing and noticeboard – or a combination of all these functions. You can choose the back of straight or sloping ledge, magnetic whiteboard included some magnets, Bulletin Board 2204, covered in any color of fabric Europost from Gabriel and mirror. Special sizes and ther finishes upon request.

It is secured to the wall using a metal rail. The ledges in solid wood and back in MDF of veneer. Finish clear lacquer. Tempered clear glass in height 32, 150 (=A5) or 230 (=A4) mm as standard and plexiglass upon request. Instead of glass for magnetic whiteboard and notice board you can choose of 15 mm wood end. Accessories: Dividers in solid wood that slot on top of the glass fronts to divide each shelf into compartments.

**Back**  
 FRB = Bulletin Board col 2204 (edge only in white, black, oak or birch)  
 FRK = Covered in fabric Europost  
 FRW = Magnetic Whiteboard (edge only in white, black, oak or birch)  
 FRS = Mirror

## Front panel utan list.

FRB = Bulletin Board col 2204 (kantlist endast i vit, svart, ek, björk)  
 FRK = Klädd i tyg Europost  
 FRW = Magnetic Whiteboard (kantlist endast i vit, svart, ek, björk)  
 FRS = Spegel

## Front panel excl. ledge.

**Back**  
 FRB = Bulletin Board col 2204 (edge only in white, black, oak, birch)  
 FRK = Covered in fabric Europost  
 FRW = Magnetic Whiteboard (edge only in white, black, oak, birch)  
 FRS = Mirror

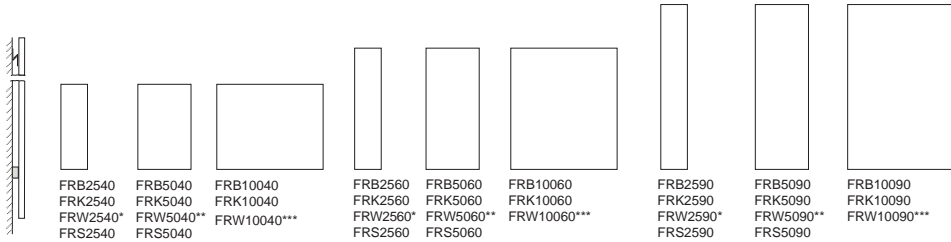

\*incl. 3 magnets  
 \*\*incl. 4 magnets  
 \*\*\*incl. 6 magnets

## Tillbehör Accessories



FRM  
 Magnet ø11

## Panel SEK Extra SEK

Artno	Bredd Width mm	Djup Depth mm	Höjd Height mm	.10 ek oak .20 björk birch .50 lack color	Standardbets på ek Standard stain on oak Vitpigment ek White glazed oak	Vikt Weight kilos	Volym Volume
FRB2540	250	30	800	2830	+290	4	0,03
FRK2540	250	30	800	4550	+460	4	0,03
FRW2540	250	30	800	3310	+340	4	0,03
FRS2540	250	30	800	2940	+290	4	0,03
FRB5040	500	30	800	3530	+360	7	0,05
FRK5040	500	30	800	5400	+540	7	0,05
FRW5040	500	30	800	4450	+430	7	0,05
FRS5040	500	30	800	3890	+390	7	0,05
FRB10040	1000	30	800	4710	+480	14	0,1
FRK10040	1000	30	800	6370	+640	14	0,1
FRW10040	1000	30	800	6400	+640	14	0,1
FRB2560	250	30	1140	3300	+340	6	0,04
FRK2560	250	30	1140	4920	+510	6	0,04
FRW2560	250	30	1140	3850	+380	6	0,04
FRS2560	250	30	1140	3500	+360	6	0,04
FRB5060	500	30	1140	4290	+420	13	0,07
FRK5060	500	30	1140	5860	+590	13	0,07
FRW5060	500	30	1140	5410	+540	13	0,07
FRS5060	500	30	1140	4540	+460	13	0,07
FRB10060	1000	30	1140	5970	+590	20	0,15
FRK10060	1000	30	1140	7670	+770	20	0,15
FRW10060	1000	30	1140	7820	+780	20	0,15
FRB2590	250	30	1550	3760	+380	11	0,06
FRK2590	250	30	1550	6030	+600	11	0,06
FRW2590	250	30	1550	4630	+460	11	0,06
FRS2590	250	30	1550	3940	+390	11	0,06
FRB5090	500	30	1550	4990	+510	18	0,1
FRK5090	500	30	1550	7200	+730	18	0,1
FRW5090	500	30	1550	6540	+650	18	0,1
FRS5090	500	30	1550	5320	+540	18	0,1
FRB10090	1000	30	1550	7080	+710	25	0,11
FRK10090	1000	30	1550	8900	+900	25	0,11
FRW10090	1000	30	1550	9510	+950	25	0,11
Tillbehör Accessories							
FRM magnet			10	90			

# FRONT PANEL Skala Design 2007



Front panel med en rak list.  
Mer information se sid 32.

Front panel incl. one straight ledge.  
More information see page 32.

Rygg  
FRB = Bulletin Board col 2204 (kantlist endast i vit, svart, ek, björk)  
FRK = Klädd i tyg Europost  
FRW = Magnetic Whiteboard (kantlist endast i vit, svart, ek, björk)  
FRS = Spegel

Back  
FRB = Bulletin Board col 2204 (edge only in white, black, oak, birch)  
FRK = Covered in fabric Europost  
FRW = Magnetic Whiteboard (edge only in white, black, oak, birch)  
FRS = Mirror

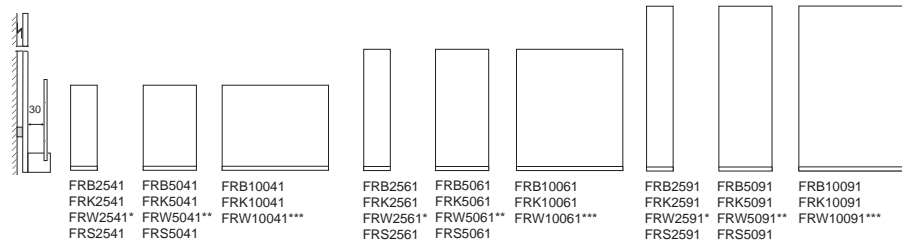

\*incl. 3 magnets  
\*\*incl. 4 magnets  
\*\*\*incl. 6 magnets

## Tillbehör Accessories



Artno	Bredd Width mm	Djup Depth mm	Höjd Height mm	Glashöjd Glass height mm	Träavslut Wood end mm	Panel SEK		Plexi FRP	Vikt Weight kilos	Volym Volume
						.10 ek oak .20 björk birch .50 lack color	Standardbets på ek Standard stain on oak Vitpigment ek White glazed oak			
FRB2541	250	70	800	32/150/230	15	3710	+370	+240	5	0,03
FRK2541	250	70	800	32/150/230	15	5400	+540	+240	5	0,03
FRW2541	250	70	800	32/150/230	15	4180	+410	+240	5	0,03
FRS2541	250	70	800	32/150/230	15	3780	+380	+240	5	0,03
FRB5041	500	70	800	32/150/230	15	4710	+480	+350	12	0,05
FRK5041	500	70	800	32/150/230	15	6580	+650	+350	12	0,05
FRW5041	500	70	800	32/150/230	15	5640	+560	+350	12	0,05
FRS5041	500	70	800	32/150/230	15	5070	+520	+350	12	0,05
FRB10041	1000	70	800	32/150/230	15	6510	+650	+490	14	0,11
FRK10041	1000	70	800	32/150/230	15	8260	+820	+490	14	0,11
FRW10041	1000	70	800	32/150/230	15	8170	+810	+490	14	0,11
FRB2561	250	70	1140	32/150/230	15	4160	+410	+240	7	0,04
FRK2561	250	70	1140	32/150/230	15	5780	+570	+240	7	0,04
FRW2561	250	70	1140	32/150/230	15	4700	+480	+240	7	0,04
FRS2561	250	70	1140	32/150/230	15	4350	+420	+240	7	0,04
FRB5061	500	70	1140	32/150/230	15	5510	+550	+350	16	0,07
FRK5061	500	70	1140	32/150/230	15	7060	+710	+350	16	0,07
FRW5061	500	70	1140	32/150/230	15	6630	+670	+350	16	0,07
FRS5061	500	70	1140	32/150/230	15	5780	+570	+350	16	0,07
FRB10061	1000	70	1140	32/150/230	15	7750	+770	+490	25	0,15
FRK10061	1000	70	1140	32/150/230	15	9440	+940	+490	25	0,15
FRW10061	1000	70	1140	32/150/230	15	9570	+950	+490	25	0,15
FRB2591	250	70	1550	32/150/230	15	4630	+460	+240	8	0,06
FRK2591	250	70	1550	32/150/230	15	6900	+690	+240	8	0,06
FRW2591	250	70	1550	32/150/230	15	5510	+550	+240	8	0,06
FRS2591	250	70	1550	32/150/230	15	4820	+490	+240	8	0,06
FRB5091	500	70	1550	32/150/230	15	6190	+610	+350	17	0,1
FRK5091	500	70	1550	32/150/230	15	8380	+830	+350	17	0,1
FRW5091	500	70	1550	32/150/230	15	7720	+770	+350	17	0,1
FRS5091	500	70	1550	32/150/230	15	6550	+650	+350	17	0,1
FRB10091	1000	70	1550	32/150/230	15	8820	+880	+490	34	0,2
FRK10091	1000	70	1550	32/150/230	15	10660	+1060	+490	34	0,2
FRW10091	1000	70	1550	32/150/230	15	11280	+1130	+490	34	0,2
<b>Tillbehör Accessories</b>										
FRAV1	12	44	38			150	+10			
FRM			10			90				

# SENAB

## 22% RABATT SKA DRAS AV PÅ ANGIVNA PRISER



# FRONT PANEL Skala Design 2007



**Front panel med raka lister.**  
Mer information se sid 32.

**Front panel incl. straight ledges.**  
More information see page 32.

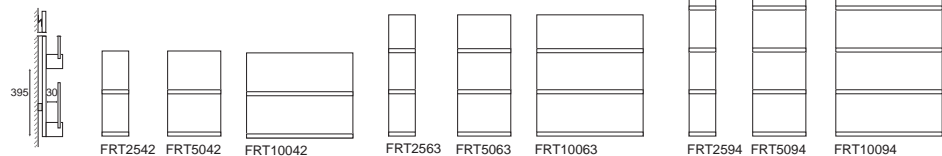

**Front panel med vinklade lister.**  
Mer information se sid 32.

**Front panel incl. sloping ledges.**  
More information see page 32.

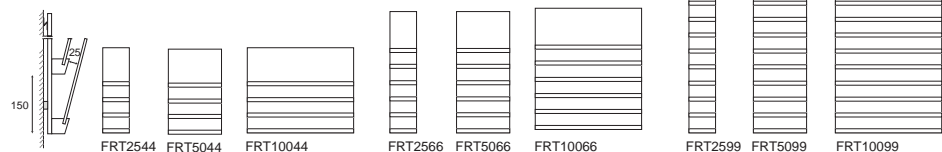

**Front panel med vinklade lister.**  
Mer information se sid 32.

**Front panel incl. sloping ledges.**  
More information see page 32.

Rygg  
FRB = Bulletin Board col 2204 (kantlist endast i vit, svart, ek, björk)  
FRK = Klädd i tyg Europost  
FRW = Magnetic Whiteboard (kantlist endast i vit, svart, ek, björk)

Back  
FRB = Bulletin Board col 2204 (edge only in white, black, oak, birch)  
FRK = Covered in fabric Europost  
FRW = Magnetic Whiteboard (edge only in white, black, oak, birch)

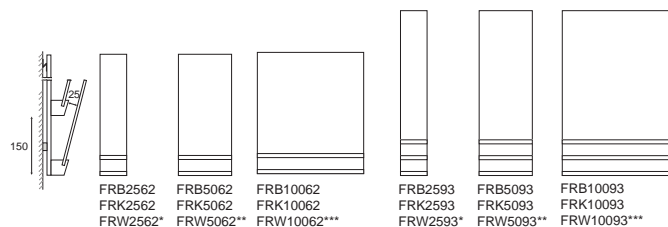

\*incl. 3 magnets  
\*\*incl. 4 magnets  
\*\*\*incl. 6 magnets

Tillbehör Accessories

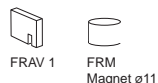

Artno	Bredd Width mm	Djup Depth mm	Höjd Height mm	Glashöjd Glass height mm	.10 ek oak .20 björk birch .50 lack color	Standardbets på ek Vitpigment ek White glazed oak	Plexi FRP	Vikt Weight kilos	Volym Volume
FRT2542	250	70	800	230	4180	+410	+510	6	0,03
FRT5042	500	70	800	230	5540	+550	+680	11	0,05
FRT10042	1000	70	800	230	7620	+760	+960	22	0,1
FRT2563	250	70	1140	230	5490	+550	+750	9	0,04
FRT5063	500	70	1140	230	7260	+730	+1020	19	0,07
FRT10063	1000	70	1140	230	10100	+1010	+1440	33	0,15
FRT2594	250	70	1550	230	6780	+680	+1000	11	0,06
FRT5094	500	70	1550	230	9010	+910	+1360	23	0,1
FRT10094	1000	70	1550	230	12550	+1260	+1940	25	0,15
FRT2544	250	115	800	230	6110	+600	+1000	10	0,03
FRT5044	500	115	800	230	8120	+810	+1360	17	0,05
FRT10044	1000	115	800	230	11310	+1130	+1940	34	0,1
FRT2566	250	115	1140	230	8360	+830	+1490	12	0,04
FRT5066	500	115	1140	230	11150	+1120	+2050	24	0,07
FRT10066	1000	115	1140	230	15690	+1570	+2920	50	0,15
FRT2599	250	115	1550	230	11490	+1160	+2240	18	0,06
FRT5099	500	115	1550	230	15450	+1550	+3050	33	0,13
FRT10099	1000	115	1550	230	21870	+2320	+4360	66	0,2
FRB2562	250	115	1140	150/230	5080	+520	+510	8	0,04
FRK2562	250	115	1140	150/230	6770	+680	+510	8	0,04
FRW2562	250	115	1140	150/230	5610	+560	+510	8	0,04
FRB5062	500	115	1140	150/230	6730	+670	+680	17	0,07
FRK5062	500	115	1140	150/230	8360	+830	+680	17	0,07
FRW5062	500	115	1140	150/230	7890	+780	+680	17	0,07
FRB10062	1000	115	1140	150/230	9570	+950	+960	35	0,15
FRK10062	1000	115	1140	150/230	11290	+1130	+960	35	0,15
FRW10062	1000	115	1140	150/230	11410	+1140	+960	35	0,15
FRB2593	250	115	1550	150/230	6480	+640	+750	10	0,06
FRK2593	250	115	1550	150/230	8750	+880	+750	10	0,06
FRW2593	250	115	1550	150/230	7240	+730	+750	10	0,06
FRB5093	500	115	1550	150/230	8760	+880	+1020	21	0,1
FRK5093	500	115	1550	150/230	10920	+1080	+1020	21	0,1
FRW5093	500	115	1550	150/230	10100	+1010	+1020	21	0,1
FRB10093	1000	115	1550	150/230	12520	+1250	+1440	42	0,2
FRK10093	1000	115	1550	150/230	14350	+1430	+1440	42	0,2
FRW10093	1000	115	1550	150/230	14720	+1460	+1440	42	0,2
FRAV1	12	44	38		150	+10			
FRM			10		90				

# FRONT FÖRVARING STORAGE Skala Design 2007

Front förvaring. Ryggen i trä med monterade raka eller vinklade lister för tidningar, broschyrer och magasin. Bakom finns det utrymme för extra förvaring. Lister är i massiv trä och rygg i MDF av faner. Härdad klarglas i höjd 230 mm. Som tillägg finns plexiglas. Förvaringen hängs på vägg med metallist. Specialmått och andra utförande efter förfrågan. Som tillbehör finns avdelare i massiv trä som sätts på glaset för indelning i fack.

Front storage. Back of wood with straight or sloping ledges for magazines and brochures. Behind extra storage spaces. Ledges in solid wood and back in veneered MDF. Tempered clear glass in height 230 mm (=A4) as standard. Plexi glass, special sizes and other finishes upon request. It is secured to the wall using a metal rail. Accessories dividers in solid wood that slot on top of the glass fronts to divide each shelf into compartments.

## Raka lister. Straight ledges.

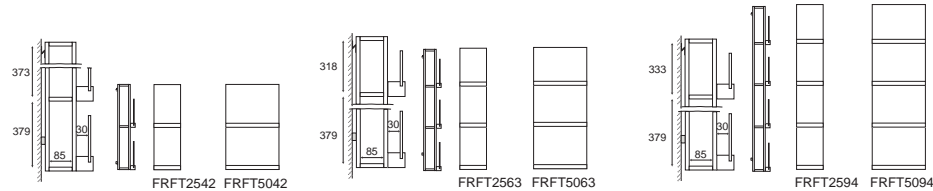

## Vinklade lister. Sloping ledges

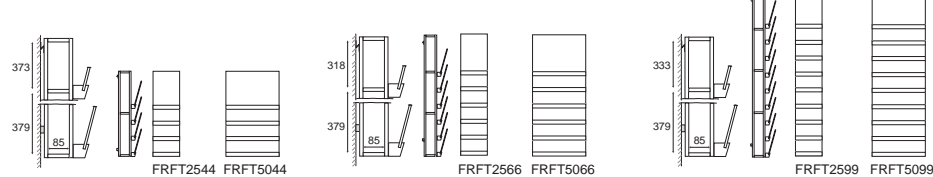

## Tillbehör Accessories



FRAV 1  
Avdelare Divider  
to FR1, FR3

		Förvaring SEK	Extra SEK
--	--	---------------	-----------

Artno	Bredd Width mm	Djup Depth mm	Höjd Height mm	Glashöjd Glass height mm	.10 ek oak .20 björk birch .50 lack color	Standardbets på ek Standard stain on oak Vitpigment ek White glazed oak	Plexi FRP	Vikt Weight kilos	Volym Volume
FRFT2542	250	175	800	230	7600	+760	+510	12	0,05
FRFT5042	500	175	800	230	9970	+1000	+680	22	0,1
FRFT2563	250	175	1140	230	9770	+990	+750	16	0,08
FRFT5063	500	175	1140	230	12700	+1270	+1020	29	0,14
FRFT2594	250	175	1550	230	12000	+1200	+1000	21	0,12
FRFT5094	500	175	1550	230	15680	+1570	+1360	40	0,2
FRFT2544	250	225	800	230	9190	+920	+1000	10	0,04
FRFT5044	500	225	800	230	12550	+1260	+1360	26	0,1
FRFT2566	250	225	1140	230	12620	+1260	+1490	20	0,08
FRFT5066	500	225	1140	230	16600	+1660	+2050	26	0,15
FRFT2599	250	225	1550	230	16730	+1670	+2240	22	0,1
FRFT5099	500	225	1550	230	22100	+2220	+3050	40	0,2
Tillbehör Accessories									
FRAV1	12	44	38		150	+10			

# FRONT FRISTÅENDE FREE-STANDING

Skala Design 2006



Front fristående finns i följande tre kombinationer.

1. Utan lister med rygg i Bulletin Board 2204 eller magnetisk whiteboard inklusive magneter.
  2. Tidsskriftsställ med raka eller vinklade lister monterade på en eller båda sidor av ryggen.
  3. En kombination med raka eller vinklade lister med rygg i trä, Bulletin Board 2204 eller magnetisk whiteboard inklusive magneter.
- Härdat klarglas i höjderna 150 (=A5) och 230 (=A4) mm. Mot tillägg finns plexiglas. Utförande foten och lister är massivt trä i ek, björk, standardfärger, standardbets på ek och vitpigmenterad ek. Ytbehandling klarlack. Specialmått och andra utförande efter förfrågan. Som tillbehör infrästa hjul i foten, ej låsbara. Extra magneter till whiteboard. Avdelare i massivt trä som sätts på glaset för indelning i fack.

Front free-standing comes in three different combinations.

1. Without ledges with back in Bulletin Board 2204 or magnetic whiteboard incl. magnets.
  2. As magazine shelf with straight or slope ledges on both sides of back.
  3. A combination of straight or sloping ledges and back in wood, Bulletin Board 2204 or magnetic whiteboard included magnets.
- Tempered clear glass in height 150 (=A5) and 230 (=A4) mm as standard. Plexi glass upon request. Base and ledges are in solid wood of oak, birch, standard colors, standard stains on oak and white glazed oak. Finish clear lacquer. Special sizes and other finishes upon request. Accessories as invisible castors, not lockable, extra magnets for whiteboard, dividers in solid wood that slot on top of the glass fronts to divide each shelf into compartments.

## Front fristående utan lister.

Rygg  
FRDB = Bulletin Board col 2204 (kantlist endast i vit, svart, ek, björk)  
FRDW = Magnetic Whiteboard (kantlist endast i vit, svart, ek, björk)

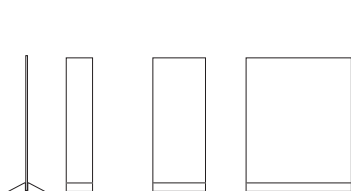

FRDB2560 FRDB5060 FRDB10060  
FRDW2560\* FRDW5060\*\* FRDW10060\*\*\*

## Front free-standing without ledges.

Back  
FRDB = Bulletin Board col 2204 (edge only in white, black, oak, birch)  
FRDW = Magnetic Whiteboard (edge only in white, black, oak, birch)

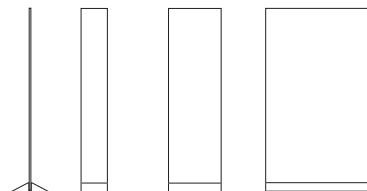

FRDB2590 FRDB5090 FRDB10090  
FRDW2590\* FRDW5090\*\* FRDW10090\*\*\*

## Front fristående vinklade lister.

Rygg  
FREB = Bulletin Board col 2204 (kantlist endast i vit, svart, ek, björk)  
FRET = Tråpanel  
FREW = Magnetic Whiteboard (kantlist endast i vit, svart, ek, björk)



FREB2566 FREB5066 FREB10066  
FRET2566 FRET5066 FRET10066  
FREW2566\* FREW5066\*\* FREW10066\*\*\*

## Front free-standing sloping ledges.

Back  
FREB = Bulletin Board col 2204 (edge only in white, black, oak, birch)  
FRET = Wooden panel  
FREW = Magnetic Whiteboard (edge only in white, black, oak, birch)

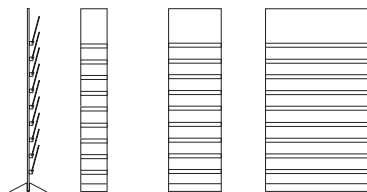

FREB2599 FREB5099 FREB10099  
FRET2599 FRET5099 FRET10099  
FREW2599\* FREW5099\*\* FREW10099\*\*\*

## Front fristående vinklade lister.

Rygg



FRDT2566 FRDT5066 FRDT10066

## Front free-standing sloping ledges.

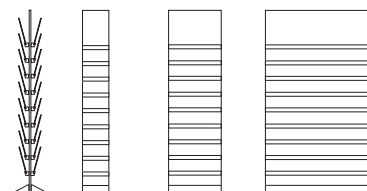

FRDT2599 FRDT5099 FRDT10099

Artno	Bredd Width mm	Djup Depth mm	Höjd Height mm	Glashöjd Glass height mm	Fothöjd Height of foot mm	Fristående SEK		Extra SEK			
						.10 ek oak .20 björk birch .50 lack color	Standardbets på ek Standard stain on oak Vitpigment ek White glazed oak	Plexi FRP	Vikt Weight kilos	Volym Volume	
FRDB2560	250	360	1300		95	7070	+710		7	0,15	
FRDW2560	250	360	1300		95	8130	+810		7	0,15	
FRDB5060	500	360	1300		95	10100	+1010		14	0,3	
FRDW5060	500	360	1300		95	12430	+1250		14	0,3	
FRDB10060	1000	360	1300		95	17160	+1720		28	0,6	
FRDW10060	1000	360	1300		95	21450	+2140		28	0,6	
FRDB2590	250	360	1750		95	7750	+770		12	0,2	
FRDW2590	250	360	1750		95	9300	+930		12	0,2	
FRDB5090	500	360	1750		95	11290	+1130		24	0,4	
FRDW5090	500	360	1750		95	14270	+1430		24	0,4	
FRDB10090	1000	360	1750		95	19180	+1920		48	0,8	
FRDW10090	1000	360	1750		95	24750	+2470		48	0,8	
FREB2566	250	360	1300	150,230	95	11680	+1170	+1490	13	0,15	
FRET2566	250	360	1300	150,230	95	10400	+1040	+1490	13	0,15	
FREW2566	250	360	1300	150,230	95	12690	+1270	+1490	13	0,15	
FREB5066	500	360	1300	150,230	95	17100	+1710	+2050	35	0,3	
FRET5066	500	360	1300	150,230	95	15170	+1530	+2050	35	0,3	
FREW5066	500	360	1300	150,230	95	19330	+1940	+2050	35	0,3	
FREB10066	1000	360	1300	150,230	95	27170	+2720	+2920	52	0,52	
FRET10066	1000	360	1300	150,230	95	23770	+2370	+2920	52	0,52	
FREW10066	1000	360	1300	150,230	95	31320	+3140	+2920	52	0,52	
FREB2599	250	360	1750	150,230	95	14710	+1460	+2240	23	0,2	
FRET2599	250	360	1750	150,230	95	13250	+1330	+2240	23	0,2	
FREW2599	250	360	1750	150,230	95	16140	+1610	+2240	23	0,2	
FREB5099	500	360	1750	150,230	95	21770	+2180	+3050	32	0,4	
FRET5099	500	360	1750	150,230	95	19390	+1940	+3050	32	0,4	
FREW5099	500	360	1750	150,230	95	24660	+2460	+3050	32	0,4	
FREB10099	1000	360	1750	150,230	95	34200	+3410	+4360	64	0,75	
FRET10099	1000	360	1750	150,230	95	29840	+2990	+4360	64	0,75	
FREW10099	1000	360	1750	150,230	95	39640	+3950	+4360	64	0,75	
FRDT2566	250	360	1300	150,230	95	15030	+1520	+2990	23	0,15	
FRDT5066	500	360	1300	150,230	95	22150	+2220	+4090	32	0,26	
FRDT10066	1000	360	1300	150,230	95	33770	+3380	+5810	76	0,59	
FRDT2599	250	360	1750	150,230	95	20200	+2010	+4480	25	0,22	
FRDT5099	500	360	1750	150,230	95	29850	+2990	+6140	62	0,4	
FRDT10099	1000	360	1750	150,230	95	44890	+4490	+8730	100	0,85	

# FRONT FRISTÅENDE FREE-STANDING

Skala Design 2006



Front fristående raka lister.



FRDT2563 FRDT5063 FRDT10063

Front free-standing straight ledges.

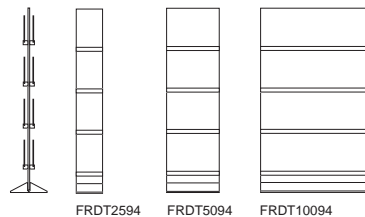

FRDT2594 FRDT5094 FRDT10094

Front fristående raka lister.

Rygg  
 FREB = Bulletin Board col 2204 (kantlist endast i vit, svart, ek, björk)  
 FRET = Träpanel  
 FREW = Magnetic Whiteboard (kantlist endast i vit, svart, ek, björk)



FREB2563 FREB5063 FREB10063  
 FRET2563 FRET5063 FRET10063  
 FREW2563\* FREW5063\*\* FREW10063\*\*\*

Front free-standing straight ledges.

Back  
 FREB = Bulletin Board col 2204 (edge only in white, black, oak, birch)  
 FRET = Wooden panel  
 FREW = Magnetic Whiteboard (edge only in white, black, oak, birch)



FREB2594 FREB5094 FREB10094  
 FRET2594 FRET5094 FRET10094  
 FREW2594\* FREW5094\*\* FREW10094\*\*\*

\*incl. 3 magnets  
 \*\*incl. 4 magnets  
 \*\*\*incl. 6 magnets

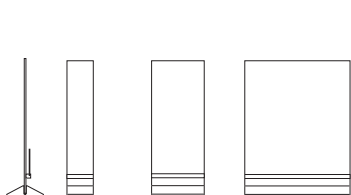

FREB2561 FREB5061 FREB10061  
 FREW2561\* FREW5061\*\* FREW10061\*\*\*



FREB2592 FREB5092 FREB10092  
 FREW2592\* FREW5092\*\* FREW10092\*\*\*

\*incl. 3 magnets  
 \*\*incl. 4 magnets  
 \*\*\*incl. 6 magnets

Tillbehör Accessories



FRAV 1  
 Avdelare Divider  
 to FR1, FR3



FRM  
 Magnet ø11



FRH  
 4st hjul ej låsbara  
 4pcs castors, not lockable

Artno	Bredd Width mm	Djup Depth mm	Höjd Height mm	Glashöjd Glass height mm	Fothöjd Height of foot mm	.10 ek oak .20 björk birch .50 lack color	Standardbets på ek Standard stain on oak Vitpigment ek White glazed oak	Plexi FRP	Vikt Weight kilos	Volym Volume
FRDT2563	250	360	1300	150,230	95	10400	+1040	+1490	16	0,15
FRDT5063	500	360	1300	150,230	95	15170	+1530	+2050	32	0,3
FRDT10063	1000	360	1300	150,230	95	23770	+2370	+2920	55	0,7
FRDT2594	250	360	1750	150,230	95	12490	+1250	+1990	24	0,22
FRDT5094	500	360	1750	150,230	95	18220	+1820	+2730	34	0,4
FRDT10094	1000	360	1750	150,230	95	28170	+2820	+3890	68	0,8
FREB2563	250	360	1300	150,230	95	9380	+940	+750	14	0,16
FRET2563	250	360	1300	150,230	95	8090	+810	+750	14	0,16
FREW2563	250	360	1300	150,230	95	10370	+1040	+750	14	0,16
FREB5063	500	360	1300	150,230	95	13610	+1360	+1020	28	0,26
FRET5063	500	360	1300	150,230	95	11670	+1170	+1020	28	0,26
FREW5063	500	360	1300	150,230	95	15850	+1580	+1020	28	0,26
FREB10063	1000	360	1300	150,230	95	22160	+2220	+1450	55	0,6
FRET10063	1000	360	1300	150,230	95	18740	+1870	+1450	55	0,6
FREW10063	1000	360	1300	150,230	95	26330	+2630	+1450	55	0,6
FREB2594	250	360	1750	150,230	95	10850	+1080	+1000	16	0,2
FRET2594	250	360	1750	150,230	95	9390	+940	+1000	16	0,2
FREW2594	250	360	1750	150,230	95	12300	+1230	+1000	16	0,2
FREB5094	500	360	1750	150,230	95	15940	+1600	+1360	32	0,4
FRET5094	500	360	1750	150,230	95	13560	+1360	+1360	32	0,4
FREW5094	500	360	1750	150,230	95	18850	+1880	+1360	32	0,4
FREB10094	1000	360	1750	150,230	95	25840	+2590	+1940	67	0,8
FRET10094	1000	360	1750	150,230	95	21500	+2140	+1940	67	0,8
FREW10094	1000	360	1750	150,230	95	31290	+3140	+1940	67	0,8
FREB2561	250	360	1300	150,230	95	7820	+780	+240	8	0,15
FRET2561	250	360	1300	150,230	95	8910	+900	+240	8	0,15
FREW2561	250	360	1300	150,230	95	11270	+1130	+350	16	0,3
FREB5061	500	360	1300	150,230	95	13610	+1360	+350	16	0,3
FRET5061	500	360	1300	150,230	95	18850	+1880	+490	52	0,52
FREW5061	500	360	1300	150,230	95	23100	+2310	+490	52	0,52
FREB10061	1000	360	1300	150,230	95	9320	+930	+510	14	0,2
FRET10061	1000	360	1300	150,230	95	10840	+1080	+510	14	0,2
FREW10061	1000	360	1300	150,230	95	13630	+1360	+680	28	0,4
FREB2592	250	360	1750	150,230	95	16600	+1660	+680	28	0,4
FRET2592	250	360	1750	150,230	95	22500	+2250	+960	56	0,8
FREW2592	250	360	1750	150,230	95	28070	+2800	+960	56	0,8
FREB5092	500	360	1750	150,230	95					
FRET5092	500	360	1750	150,230	95					
FREW5092	500	360	1750	150,230	95					
FREB10092	1000	360	1750	150,230	95					
FRET10092	1000	360	1750	150,230	95					
FREW10092	1000	360	1750	150,230	95					
FRAV1	12	44	38			150	+10			
FRH						1250				

SENAB

22% RABATT SKA DRAS AV PÅ ANGIVNA PRISER



Ridå används som tidskrifts-, broschyrställ, spegel, anslagstavla, skrivtavla eller en kombination av dessa. Facken är pressad formfilt, ljusgrå eller antracit och som ger en viss ljudabsorberande effekt. Ramen tillverkas i fänerad MDF. Ytbehandling klarlack. Ridå hängs på vägg med metallist. Välj ryggen i ljusgrå alternativt antracit filt, spegel, whiteboard, trä. (Om filtack önskas kläs i tyg Comfort, återkom för offert). Samtliga ryggar är magnetiska. Ridå i bredd 371 kan hängas både vertikalt och horisontellt. Tillbehör: Aluminiumlist som kan användas som namnskylt.

Ridå is used as a magazine, brochure stand, mirror, bulletin board, writing board or a combination of these. The compartments are pressed form felt, light gray or anthracite and which give a certain sound-absorbing effect. The frame is made of veneered MDF surface treatment clear lacquer. Ridå is hung on the wall with a metal strip. Choose the back in light gray alternative anthracite blanket, mirror, whiteboard, wood. (If felt compartment is desired to be upholstered in fabric Comfort, please return for a quote) All backs are magnetic. Ridå in width 371 can be hung both vertically and horizontally. Accessories: Aluminum strip that can be used as a name plate.

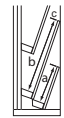

a = 110mm  
b = 200mm  
c = 25mm

### Ridå Vägghängd

Välj rygg av följande material  
RIVF = Filt ljusgrå eller antracit  
RIVS = Spegel  
RIVT = Trä  
RIVW = Whiteboard

### Ridå Wall model

Choose back of the following materials  
RIVF = Felt in light gray or anthracite  
RIVS = Mirror  
RIVT = Wood  
RIVW = Whiteboard

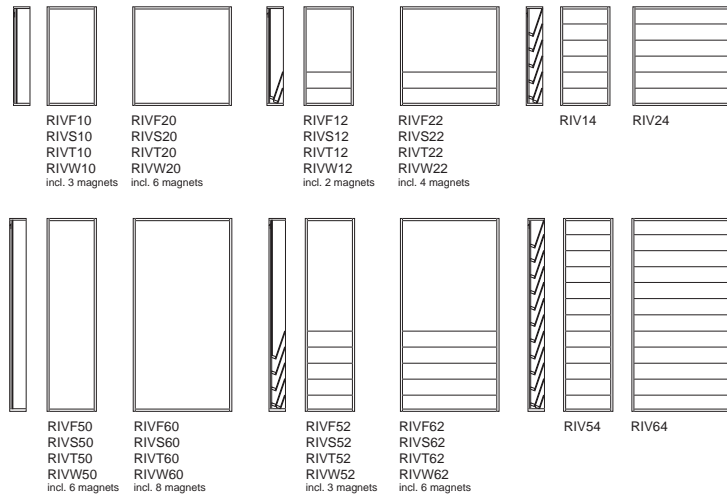

### Tillbehör Accessories



RIA - Aluminium

Artno	Bredd Width mm	Djup Depth mm	Höjd Height mm	Filtack Felt pocket	Ridå SEK		Vikt Weight kilos	Volym Volume
					.10 ek oak .20 björk birch .50 lack color	Standardbets på ek   Standard stain on oak Vitpigment ek   White glazed oak		
RIVF10	371	124	742		5680	+560	10	0,06
RIVS10	371	124	742		5450	+550	10	0,06
RIVT10	371	124	742		5450	+550	10	0,06
RIVW10	371	124	742		5760	+570	10	0,06
RIVF20	742	124	742		6770	+680	15	0,12
RIVS20	742	124	742		6390	+640	15	0,12
RIVT20	742	124	742		6390	+640	15	0,12
RIVW20	742	124	742		7080	+710	15	0,12
RIVF12	371	124	742	ljusgrå light gray or anthracite	6590	+650	11	0,06
RIVS12	371	124	742	ljusgrå light gray or anthracite	6390	+640	11	0,06
RIVT12	371	124	742	ljusgrå light gray or anthracite	6300	+630	11	0,06
RIVW12	371	124	742	ljusgrå light gray or anthracite	6690	+670	11	0,06
RIVF22	742	124	742	ljusgrå light gray or anthracite	8110	+810	15	0,12
RIVS22	742	124	742	ljusgrå light gray or anthracite	7720	+770	15	0,12
RIVT22	742	124	742	ljusgrå light gray or anthracite	7720	+770	15	0,12
RIVW22	742	124	742	ljusgrå light gray or anthracite	8420	+830	15	0,12
RIV14	371	124	742	ljusgrå light gray or anthracite	7090	+710	11	0,06
RIV24	742	124	742	ljusgrå light gray or anthracite	8930	+900	15	0,12
RIVF50	371	124	1451		7710	+770	16	0,1
RIVS50	371	124	1451		7410	+740	16	0,1
RIVT50	371	124	1451		7410	+740	16	0,1
RIVW50	371	124	1451		7560	+760	16	0,1
RIVF60	742	124	1451		9510	+940	25	0,22
RIVS60	742	124	1451		9020	+910	25	0,22
RIVT60	742	124	1451		9020	+910	25	0,22
RIVW60	742	124	1451		10000	+1000	25	0,22
RIVF52	371	124	1451	ljusgrå light gray or anthracite	9900	+990	17	0,1
RIVS52	371	124	1451	ljusgrå light gray or anthracite	9570	+950	17	0,1
RIVT52	371	124	1451	ljusgrå light gray or anthracite	9570	+950	17	0,1
RIVW52	371	124	1451	ljusgrå light gray or anthracite	9790	+990	17	0,1
RIVF62	742	124	1451	ljusgrå light gray or anthracite	12870	+1280	25	0,22
RIVS62	742	124	1451	ljusgrå light gray or anthracite	12380	+1250	25	0,22
RIVT62	742	124	1451	ljusgrå light gray or anthracite	12380	+1250	25	0,22
RIVW62	742	124	1451	ljusgrå light gray or anthracite	13380	+1340	25	0,22
RIV54	371	124	1451	ljusgrå light gray or anthracite	10810	+1070	17	0,1
RIV64	742	124	1451	ljusgrå light gray or anthracite	13930	+1390	25	0,22

RIA

70

80 Aluminium

Slope en exponeringshylla där olika höjder, bredder och tjocklekar av informationsmaterial och tidningar kan samsas.

Slope har bakåt lutande hyllplan, vilket ger en möjlighet att lägga upp tunt som tjockt material

och olika höjder utan det viker sig eller faller framåt. Slope finns i fyra höjder och fyra bredder antingen endast med lutande hyllplan eller kombination med magnetisk whiteboard eller anslagstavla i Bulletin Board färg antracit nr 2209 eller klädd filt i färgerna ljusgrå, antracit och offwhite. Vid förfrågan klädd filt i tyg Comfort från Gabriel. Upphängningen är metallist på vägg.

Tillbehör: Elastiskt band i vit eller svart som håller papper på plats.

Slope a display shelf on which you can combine informative material and magazines of varying height, width and thickness. Slope's shelves lean backwards, which enable you to display both thin and thick materials of different heights without them folding over or falling forwards. Slope is available in four heights and four widths, either with sloping shelves only or combined with a magnetic whiteboard or noticeboard covered in Bulletin Board in anthracite grey (color number 2209) or felt in color light-grey, anthracite and offwhite. Upon request covered felt in Comfort fabric from Gabriel. A metal rail is used to hang it on the wall. As an optional extra you can choose an elastic band in black or white that keeps papers, magazines, etc. in place.

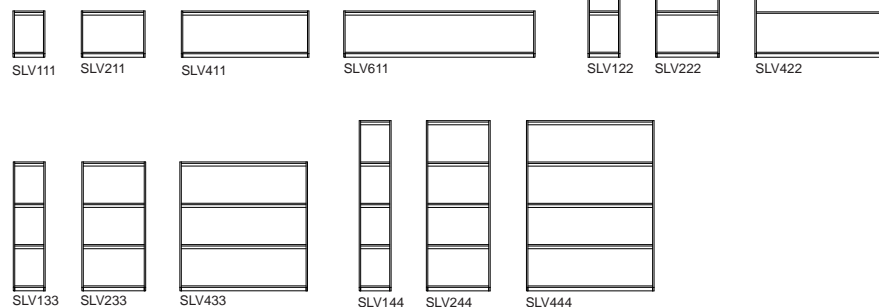
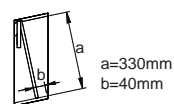

Välj rygg av följande material  
SLVB = Bulletin Board col. 2209  
SLVW = Magnetisk whiteboard  
SLVF = Filt i ljusgrå, antracit eller offwhite

Choose back of the following materials  
SLVB = Bulletin Board col. 2209  
SLVW = Magnetic Whiteboard  
SLVF = Felt in lightgray, anthracite or offwhite

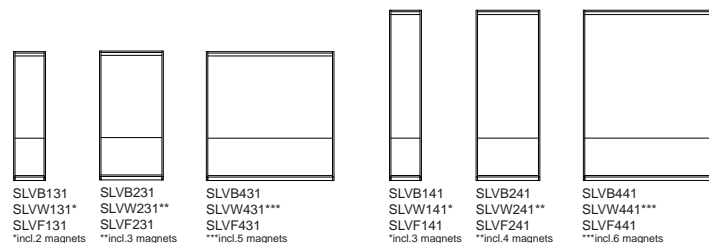

Tillbehör Accessories



Resårband vit eller svart  
Elastic rope white or black

Artno	Bredd Width mm	Djup Depth mm	Höjd Height mm	.10 ek oak .20 björk birch	.50 lack color	Standardbets på ek Standard stain on oak Vitpigment ek White glazed oak	Vikt Weight kilos	Volym Volume	
SLV111	270	143	392	3660	2890	+550	5	0,03	
SLV211	540	143	392	4470	3450	+670	8	0,05	
SLV411	1080	143	392	5840	4530	+880	12	0,1	
SLV611	1620	143	392	7740	5750	+1170	14	0,15	
SLV122	270	143	741	4890	3790	+740	8	0,05	
SLV222	540	143	741	6250	4940	+940	10	0,08	
SLV422	1080	143	741	8480	6670	+1270	20	0,16	
SLV133	270	143	1091	6220	5070	+930	9	0,06	
SLV233	540	143	1091	8110	6540	+1210	13	0,13	
SLV433	1080	143	1091	11150	8790	+1670	23	0,25	
SLV144	270	143	1440	7850	6330	+1180	10	0,08	
SLV244	540	143	1440	10040	7940	+1520	16	0,15	
SLV444	1080	143	1440	13780	10970	+2070	28	0,33	
SLVB131	270	143	1091	6160	5110	+920	8	0,06	
SLVW131	270	143	1091	6290	5240	+940	8	0,06	
SLVF131	270	143	1091	5810	4790	+880	8	0,06	
SLVB231	540	143	1091	8230	6890	+1230	13	0,13	
SLVW231	540	143	1091	8500	7180	+1270	13	0,13	
SLVF231	540	143	1091	7610	6250	+1140	13	0,13	
SLVB431	1080	143	1091	11600	9740	+1740	23	0,2	
SLVW431	1080	143	1091	12690	10850	+1910	23	0,2	
SLVF431	1080	143	1091	10630	8760	+1600	23	0,2	
SLVB141	270	143	1440	7620	6310	+1140	10	0,08	
SLVW141	270	143	1440	7780	6470	+1170	10	0,08	
SLVF141	270	143	1440	7310	6000	+1100	10	0,08	
SLVB241	540	143	1440	9720	8350	+1450	16	0,15	
SLVW241	540	143	1440	10150	8780	+1530	16	0,15	
SLVF241	540	143	1440	9240	7890	+1390	16	0,15	
SLVB441	1080	143	1440	13900	12160	+2090	28	0,33	
SLVW441	1080	143	1440	15300	13570	+2300	28	0,33	
SLVF441	1080	143	1440	13300	11560	+1990	28	0,33	
<b>Tillbehör Accessories</b>				<b>per styck each</b>					
Resår vit eller svart. Elastic white or black	270			140					
Resår vit eller svart. Elastic white or black	540			150					
Resår vit eller svart. Elastic white or black	1080			170					
Resår vit eller svart. Elastic white or black	1620			230					

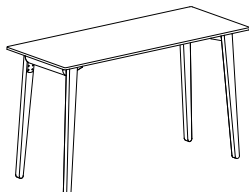

Träben Legs of wood



Stålben Legs of steel

#### Fällbord

##### SKIVA

Träfanerad MDF i ek, björk, ask, standardbets på ask, vitpigmentrad ek och ask. Ybehandling klarlack.  
Vit laminat NCS S0502-G50Y.  
Svart laminat Fenix NTM 0720 Nero Ingo, S8500-N  
Svart desktop nr 4023 nero, NCS S9000-N.  
Högtryckslaminat ek nr F5374 NAT, björk nr F7555 MAT, ask nr F8843 NAT. (PR3140 finns ej i ek, björk, ask laminat)  
Tjocklek: Rektangulär skiva 13mm. Rund skiva 17mm.

##### KANTLIST

Massiv trä ek, ask eller björk.  
Standardbets på ask, endast på träfanerad skiva i samma färg.  
Vit eller svart, ABS.

##### BEN

Ihopfällda höjd 85mm.  
Träben i massiv ek, björk, ask, standardbets på ask och vitpigment ek och ask. Ybehandling klarlack.  
Stålben i blankkrom, cr3+.  
Stålben i pulverlack med finstruktur i svart RAL9005 eller grå RAL9006/07.  
Filtass på samtliga bord.  
Vid behov av större avstånd mellan långsidans ben vänligen kontakta [info@karl-andersson.se](mailto:info@karl-andersson.se)

##### STAPLINGS- OCH KLÄMSKYDD

Filt färg antracit som standard.  
Som tillval och ska noteras på order ljusgrå eller offwhite filt.

##### TILLBEHÖR

Ljudabsorbent under bordsskiva, kan ej kombineras med eluttag.  
Bordspanel antracit filt som hängs på krokar. Eller som tillval ljusgrå eller offwhite filt.  
Kopplingsbeslag för kortsida och vissa storlekar för långsida.  
Två hjul, ej låsbara vilket ger något ökad rörlighet mot golvet (endast för träben).  
Eluttag - tre varianter. Anslutningskabel 5 meter, med jordad Schucko stickpropp och vidarekopplingskabel 3 meter, för seriekoppling mellan bord.  
Förvaringsvagn med handtag i metall kan placeras på kortsida (plats för 13 bord) eller långsidan (plats för 7 bord), låsbara hjul. För bord med längd 1600 mm och längre rekommenderas att de transporteras liggande varför handtaget ska monteras på vagnens långsida.

##### ÖVRIGT

Specialmått och andra utförande efter förfrågan. Bordet levereras monterat.

##### VID ORDER ANGE

Artikelnummer, på bord och tillbehör. Utförande på skiva, kantlist, ben och färg på staplings- och klämskydd.

#### Folding table

##### TOP

Wooden top veneered on MDF in oak, birch, ash, standard stain on ash, white glazed on oak or ash. Finish clear lacquer.  
White laminate NCS S0502-G50Y.  
Black laminate Fenix NTM 0720 Nero Ingo, S8500-N  
Black desktop no 4023 nero, NCS S9000-N.  
High Pressure Laminate oak no F5374 NAT, birch no F7555 MAT, ash no F8843 NAT. (PR3140 not available in HPL)  
Thickness: Rectangulare top 13mm. Round top 17mm.

##### EDGE

Solid wood in oak, birch, ash.  
Standard stain on ash, only on wooden top in same color.  
White or black ABS.

##### LEGS

Folding height 85mm.  
Solid wood in oak, birch, ash, standard stain on ash, white glazed on oak or ash. Finish clear lacquer.  
Steel in finish polished chrome, cr3+.  
Steel in finish powder coating with fine texture in black RAL9005 or gray RAL9006/07.  
All tables have felt floor protection.  
If you need a greater distance between the legs of the long side, please contact [info@karl-andersson.se](mailto:info@karl-andersson.se)

##### STACKING- / SAFTEY COVER

Felt in color anthracite as standard.  
As option color and state when ordering light gray or offwhite felt.

##### ACCESSORIES

Sound-absorbent panel for concealed installation under the tabletop, which cannot be combined with electrical outlets.  
Modesty panel in antracite felt which hangs on hooks, or lightgray or offwhite.  
Two wheels which are note lockable, giving slightly mobility to the floor, (only for wooden legs).  
Link fittings short side to short side. Some tables even for long side.  
Power outlet - three different types. Start cable 5metres, with saftey plug, Schuko and cable to connect 3metres, with other tables.  
Storage trolley with locking wheels and a metal handle, placed either on the short end (for 13 tables) or the long side (7 tables).  
For tables with a length 1600mm or longer we recommend that they are transported horizontally, which means that the handle is to be mounted on the trolley's long side.

##### MORE INFORMATION

Special sizes and other finishes upon request. The table comes pre-assembled.

##### STATE WHEN ORDERING

Article number for table and accessories. Execution on table top, edge, legs and color of stacking- / saftey cover.

Artno

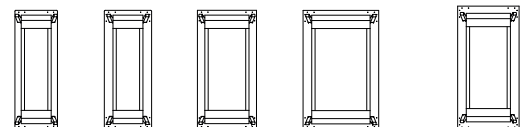

PR112545 PR112550 PR112562 PR112580 PR113065

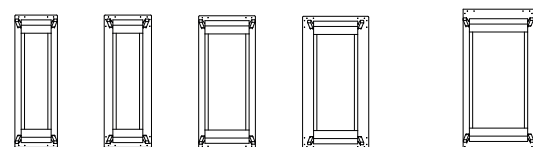

PR114045 PR114050 PR114060 PR114070 PR115075

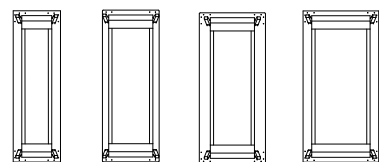

PR116050 PR116060 PR116070 PR116080

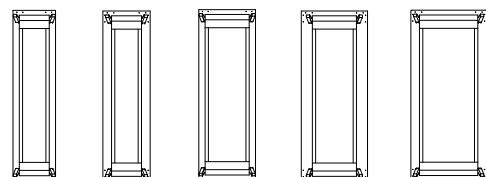

PR118045 PR118050 PR118060 PR118070 PR118080

Tillbehör Accessories	Artno	Mått Dimension mm		SEK
	PRK		<b>Kopplingsbeslag. Alla bord kan kopplas kortsida mot kortsida. Följande bord kan kopplas långsida mot långsida. PR1 12550, PR1 13065, PR1 14050, PR1 14070, PR1 16080, PR1 18050, PR1 18070, PR1 18080. Observera!! priset är baserat på koppling kortsida mot kortsida alternativt långsida mot långsida.</b> Link fittings. All tables can be connected short side to short side. The following table can be connected long side to long side. PR1 12550, PR1 13065, PR1 14050, PR1 14070, PR1 16080, PR1 18050, PR1 18070, PR1 18080. Note!! The price is for link fittings short side to short side or long side to long side.	790
	PRH		<b>Hjul endast till träben. Monterat på två bordssben, grå. Ej låsbara vilket ger något ökad rörlighet mot golvet.</b> Castors only to the wooden legs. Placed on two legs, grey. Not lockable, giving slightly mobility to the floor.	410/2pcs
	TKB7P	ø115	<b>Twist. Lock borstat rostfritt stål. 2 eluttag 220V. 2 kabelhållare exkl kablar. Gäller för SE,NO,FIN,DE,NL</b> Twist. Brushed stainless lid. 2 Electrical outlets 220V. 2 cable holders excl. cables. For SE,NO,FIN,DE,NL	3480
	TKB11P	ø57	<b>Powerdot Mini. 1 eluttag, svart, 2 kabelhållare exkl kablar. Gäller för SE,NO,FIN,DE,NL.</b> Powerdot Mini. 1 electrical black, 2 cable holders excl. cables. For SE,NO,FIN,DE,NL	1470
	TKB12P	ø57	<b>Powerdot Mini. USB A laddare inkl. 2 portar, svart. Kabelhållare exkl kablar. Gäller för SE,NO,FIN,DE,NL.</b> Powerdot Mini USB A charging incl. 2 ports, black. 2 cable holders excl. cables. For SE,NO,FIN,DE,NL	1920
	TKB19P	ø57	<b>Powerdot Mini. USB C laddare inkl. 2 portar, svart. Kabelhållare exkl kablar. Gäller för SE,NO,FIN,DE,NL.</b> Powerdot Midi. USB C charging 2 ports, black. 2 cable holders excl. cables. For SE,NO,FIN,DE,NL	2120
	TKB20P	ø70	<b>Powerdot Midi. 1 eluttag, 1 USB C laddare, svart. Kabelhållare exkl kablar. Gäller för SE,NO,FIN,DE,NL.</b> Powerdot Midi. 1 electrical, 1 USB C charging, black. 2 cable holders excl. cables. For SE,NO,FIN,DE,NL	2120
	TKB9P	L 155 W 63	<b>Kabelgenomföring. Lock i borstat rostfritt stål. 3 jordade eluttag på undersidan av bordsskivan. 2 kabelhållare, exkl. kablar. Gäller för SE,NO,FIN,DE,NL, andra länder mot offert.</b> Cable slot. Brushed stainless steel lid. 3 electrical outlets placed under the table top. 2 cable holders, excl. cables. For SE,NO,FIN,DE,NL other countries upon request	1640
	PRCA5	L 5000	<b>Anslutningskabel. 5 meter med jordad Schuko stickpropp</b> Start cable. 5 meters with safety Schuko plug	530
	PRCV3	L 3000	<b>Vidarekopplingskabel. 3 meter, för seriekoppling mellan bord.</b> Connecting cable 3 meters between tables.	390
	PRV	L 1210 W 700 H 1057	<b>Vagn. Låsbara hjul. Handtag kan monteras på lång- eller kortsida. För bord med längd 1600 mm och längre rekommenderas att borden transporteras liggande, varför handtaget ska monteras på vagnens långsida.</b> <b>Plats antal bord, handtag kortsida 13st.</b> <b>Plats antal bord, handtag långsida 7st.</b> Trolley. Lockable castors. Handle mounted on long- or shortside. For tables with a length 1600 mm and longer, we recommend that they are transported horizontally, which means that the handle is to be mounted on the trolley's long side. Numbers of table, 13pcs handle on shortside. Numbers of table, 7pcs handle on longside. 16kg 1,0kbn <sup>3</sup>	7910



Artno	Längd Length mm	Bredd Width mm	Diam. mm	Höjd Height mm	Press SEK				Extra SEK					Avdrag Reduction		
					Top faneer veneer Ben Legs .10 ek oak .20 björk birch .30 ask ash	Top Vit White Laminate Ben Legs .61 ek oak .62 björk birch .63 ask ash	Top Svart Black Laminate Ben Legs .65 ek oak .66 björk birch .67 ask ash	Top Svart Black Desktop Ben Legs .91 ek oak .92 björk birch .93 ask ash	Standardbets på ask skiva+ben Standard stain on ash top+legs	Standardbets på ask skiva Standard stain on ash top	Standardbets på ask ben Standard stain on ash legs	Höjd Height 900mm	Bordspanel filt H280mm Modesty panel felt H280mm	Ljudabsorbent Sound absorber	Stälben blankkrom Steel legs polished chrome	Stälben pulverlack svart eller grå Steel legs powder coating black or gray
PR112545	1250	450		725	9560	9760	10450	10100	+1450	+420	+1020		+1050	+510	+490	/.620
PR112550	1250	500		725	9670	9860	10530	10200	+1450	+420	+1020		+1050	+510	+490	/.620
PR112562	1250	625		725	10120	10310	11060	10730	+1530	+510	+1020		+1050	+740	+490	/.620
PR112580	1250	800		725	11280	11490	12230	11880	+1700	+510	+1140		+1050	+740	+490	/.620
PR113065	1300	650		725	10520	10720	11580	11170	+1560	+520	+1050		+1100	+740	+490	/.620
PR114045	1400	450		725	10080	10270	11080	10760	+1520	+430	+1060		+1260	+510	+490	/.620
PR114050	1400	500		725	10150	10340	11130	10840	+1530	+460	+1060		+1260	+510	+490	/.620
PR114060	1400	600		725	10610	10810	11640	11310	+1600	+520	+1060		+1260	+740	+490	/.620
PR114070	1400	700		725	10750	10960	11820	11480	+1640	+560	+1060		+1260	+740	+490	/.620
PR115075	1500	750		725	12160	12390	13240	13050	+1830	+630	+1200		+1280	+740	+490	/.620
PR116050	1600	500		725	10970	11170	11990	11840	+1810	+590	+1210	+610	+1300	+690	+490	/.620
PR116060	1600	600		725	11430	11640	12490	12330	+1810	+590	+1210	+610	+1300	+1050	+490	/.620
PR116070	1600	700		725	11730	11940	12770	12620	+1810	+590	+1210	+610	+1300	+1050	+490	/.620
PR116080	1600	800		725	12420	12660	13490	13350	+1860	+640	+1210		+1300	+1050	+490	/.620
PR118045	1800	450		725	11100	11290	12130	11970	+1670	+560	+1100	+610	+1340	+680	+490	/.620
PR118050	1800	500		725	11240	11430	12250	12110	+1700	+570	+1100	+610	+1340	+680	+490	/.620
PR118060	1800	600		725	11680	11880	12840	12580	+1750	+590	+1170	+610	+1340	+1050	+490	/.620
PR118070	1800	700		725	11880	12090	13030	12780	+1790	+610	+1170	+610	+1340	+1050	+490	/.620
PR118080	1800	800		725	12690	12920	13970	13620	+1920	+680	+1260		+1340	+1050	+490	/.620



Information

Artno	Vikt netto Weight net kilos	Vikt brutto Weight gross kilos	Volym Volume	Ihopfällt Folding mm	*Avstånd ben långsida avser sitthöjd 450mm *Distance legs long side, refers to seat height 450mm mm	Avstånd ben kortsida avser sitthöjd 450mm Distance legs short side, refers to seat height 450mm mm	Kopplingsbart kort sida Connected short side	Kopplingsbart långsida Connected long side
PR112545	13	16	0,09	85	1027	343	YES	----
PR112550	13,5	18	0,09	85	1027	343	YES	YES
PR112562	15	20	0,11	85	1027	493	YES	----
PR112580	16	24	0,14	85	1027	643	YES	----
PR113065	16	22	0,11	85	1027	493	YES	YES
PR114045	14	20	0,12	85	1177	343	YES	----
PR114050	14,5	22	0,12	85	1177	343	YES	YES
PR114060	16	26	0,13	85	1177	493	YES	----
PR114070	17	26	0,14	85	1177	493	YES	YES
PR115075	19	28	0,15	85	1177	643	YES	----
PR116050	17	26	0,13	85	1377	343	YES	YES
PR116060	17,5	26	0,14	85	1377	493	YES	----
PR116070	19	28	0,15	85	1377	493	YES	YES
PR116080	21	30	0,17	85	1377	643	YES	YES
PR118045	15,5	22	0,13	85	1577	343	YES	----
PR118050	16,5	24	0,13	85	1577	343	YES	YES
PR118060	20	26	0,16	85	1577	493	YES	----
PR118070	20,5	28	0,18	85	1577	493	YES	YES
PR118080	22	30	0,20	85	1577	643	YES	YES

\*Vid behov av större avstånd mellan långsidans ben vänligen kontakta info@karl-andersson.se  
 \*If you need a greater distance between the legs of the long side, please contact info@karl-andersson.se

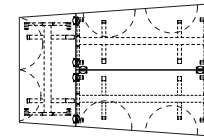
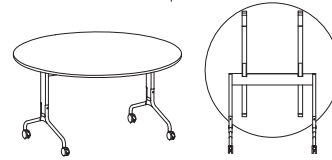

Exempel ihopkoppling av trapetsbord  
Example of connecting a trapezoidal table

### Fällbord.

Rollo fälls med ett fjäderande tvåhåndsgrepp som gör att bordet är enkelt att fälla och ger maximalt utrymme för karmstolar men som också säkerställer att skivan inte fälls upp av misstag. Bordsskivan är även balanserad så att den fällda skivan alltid står i rakt uppfällt läge. Bord med uppfälld skiva kan sättas ihop och staplas sidledes i varandra. Bordsskivan är i fänerad MDF av ek, ask, björk, standardbetser på ask, vitpigmenterad ek eller ask. Alternativt högtryckslaminat (vit, svart, ek, björk, ask) och svart desktop. Balk och gavel är i massivt trä, utförande lika bordsskivan. Kantlistens utföranden, på bordsskivan är rak och följer balk och gavel. Benavslut av metall med ytbehandling av pulverlackad finstruktur i vit (RAL 9016), svart (RAL 9005) alternativt grå (RAL9006/07). Borden är försedda med fyra svarta låsbara hjul.

Tillval till rektangulära bordet är kopplingsbeslag, bordsfront i svart eller vit kompaktlaminat och olika eluttag. När bord är försedda med eluttag fälls och ställs undan förvaras kablarna i balken som är monterad under bordsskivan. Bordet levereras monterat. Bengavlarna monteras på bordsbalken. Vid behov kan samtliga delar enkelt demonteras med enkla handverktyg.

### Folding table.

A spring-loaded construction ensures that Rollo opens easily with a two-handed grip, providing the maximum space for chairs with arms while also ensuring that the table cannot fold up accidentally. The tabletop is carefully balanced so that it is always perfectly level when unfolded. When folded, tables can be placed close together and stacked side by side. The tabletop is made of veneered MDF, finished in oak, ash, birch, standard stains on ash, white glaze on oak or ash. The table top is also available in High Pressure Laminate (white, black, oak, ash, birch) or black desktop. The centre beam and ends are of solid wood in the same finish as the top. The edge of table top is straight and finish is the same as the centre beam and ends. Table legs terminate in a metal foot with a finely textured powder lacquer finish in white (RAL 9016), black (RAL 9005) or grey (RAL9006/07). Each table is fitted with four black wheels that can be locked in place.

Link fittings, modesty panel in black or white compact laminate and various electric outlets are available as optional extras. Tables equipped with electric outlets have cable ducts with a wooden finish, so cables can be kept in place under the tabletop when the table is folded for storage. The table is supplied unassembled. The leg frames are to be fitted to the central beam. If required, the table can be easily dismantled into its component parts using only simple hand tools.

### Artno

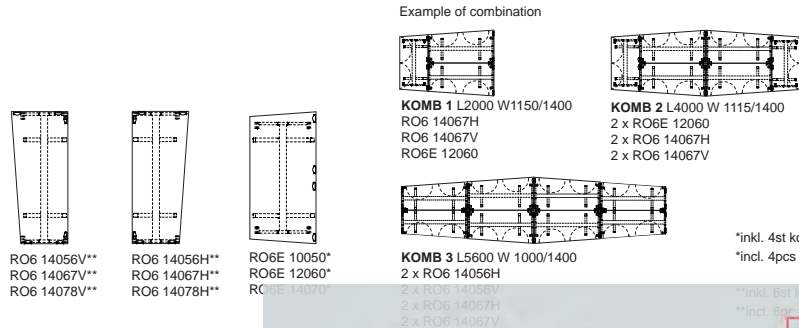
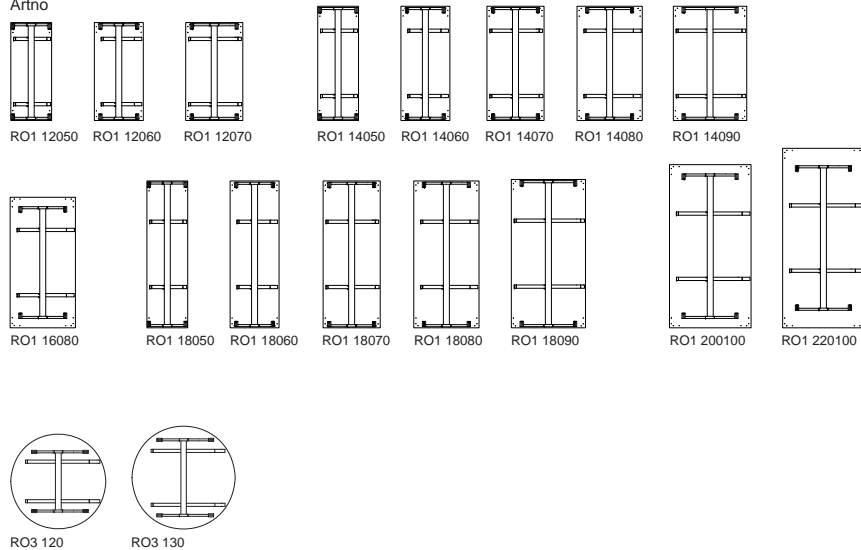

Example of combination

**KOMB 1** L2000 W1150/1400  
RO6 14067H  
RO6 14067V  
RO6E 12060

**KOMB 2** L4000 W 1115/1400  
2 x RO6E 12060  
2 x RO6 14067H  
2 x RO6 14067V

**KOMB 3** L5600 W 1000/1400  
2 x RO6 14056H  
2 x RO6 14057H  
2 x RO6 14057V

\*inkl. 4st kopplingsbeslag  
\*incl. 4pcs link fittings

\*inkl. 6st kopplingsbeslag  
\*incl. 6pcs link fittings

Tillbehör Accessories	Artno	Dimension mm		SEK
	TKB7R	ø115	<b>Twist. Lock borstat rostfritt stål. 2 Eluttag. 2m kabel. Gäller för SE, NO, FIN, DE, NL.</b> Twist. Brushed stainless lid. 2 Electrical. 2m cables. For SE,NO,FIN,DE,NL.	2880
	TKB11R	ø57	<b>Powerdot Mini. 1 eluttag, svart, 1,5m kabel. Gäller för SE,NO,FIN,DE,NL.</b> Powerdot Mini. 1electrical black, 1,5m cable. For SE,NO,FIN,DE,NL	1060
	TKB12R	ø57	<b>Powerdot Mini. USB A laddare inkl. 2 portar, svart, 1,5m kabel. Gäller för SE,NO,FIN,DE,NL.</b> Powerdot Mini. USB charging incl. 2 ports, black. 1,5m cable. For SE,NO,FIN,DE,NL	1430
	TKB19R	ø57	<b>Powerdot Mini. USB C laddare inkl. 2 portar, svart, 1,25m kabel. Gäller för SE,NO,FIN,DE,NL.</b> Powerdot Midi. USB C charging 2 ports, black. 1,25m cable. For SE,NO,FIN,DE,NL	1730
	TKB20R	ø70	<b>Powerdot Midi. 1 eluttag, 1 USB C laddare, svart, 1,25m kabel. Gäller för SE,NO,FIN,DE,NL.</b> Powerdot Midi. 1 electrical, 1 USB C charging, black. 1,25m cable. For SE,NO,FIN,DE,NL	1730
	ROK		<b>Kopplingsbeslag. Rektangulära bord kan kopplas på kort- och långsida. Observera! priset är baserat på koppling kortsida mot kortsida alternativt långsida mot långsida.</b> Link fittings. Rectangulare tables can be connected short side to short side or longside to longside. Note! The price is for link fittings short side to short side or long side to long side.	630
	ROFRP	L1200 L1400 L1600 L1800 L2000 L2200	<b>Bordspanel. Endast i svart eller vit kompaktlaminat. Upphängningskrok svart.</b> Modesty panel. Only in black or white compact laminate Hook in black.	pris sid. 27 price page 27

Artno	Längd Length mm	Bredd Width mm	Höjd Height mm	Diam mm	Rollo SEK				Extra SEK				Vikt netto Weight net kilos	Vikt brutto Weight gross kilos	Volym Volume
					Top faneer veneer Ben Legs .10 ek oak .20 björk birch .30 ask ash	Top Vit White Laminate Ben Legs .61 ek oak .62 björk birch .63 ask ash	Top Svart Black Laminate Ben Legs .65 ek oak .66 björk birch .67 ask ash Top Laminate Ben Legs .71 ek oak .72 björk birch .73 ask ash	Top Svart Black Desktop Ben Legs .91 ek oak .92 björk birch .93 ask ash	Standardbets på ask skiva Standard stain on ash top  Vitpigment White glazed	Standardbets på ask ben Standard stain on ash legs  Vitpigment White glazed	Höjd Height 900mm	Bordspanel Svart eller vit Modesty panel black or white H300			
RO1 12050	1200	500	730		11730	11910	12570	12250	+250	+540	+340	+1170	19	24	0,15
RO1 12060	1200	600	730		11910	12090	12820	12500	+270	+540	+340	+1170	22	27	0,17
RO1 12070	1200	700	730		12520	12700	13450	13100	+320	+540	+340	+1170	25	30	0,2
RO1 14050	1400	500	730		12610	12710	13500	13280	+310	+590	+340	+1230	22	27	0,16
RO1 14060	1400	600	730		12800	12990	13740	13490	+320	+590	+340	+1230	25	30	0,2
RO1 14070	1400	700	730		13450	13640	14480	14130	+360	+590	+340	+1230	28	33	0,22
RO1 14080	1400	800	730		13640	13850	14680	14330	+370	+590	+340	+1230	32	37	0,23
RO1 14090	1400	900	730		16070	16270	17120	16750	+400	+590	+340	+1230	36	41	0,23
RO1 16080	1600	800	730		15850	16080	16980	16680	+590	+590	+340	+1310	31	36	0,25
RO1 18050	1800	500	730		16020	16240	17020	16800	+530	+670	+340	+1470	28	33	0,2
RO1 18060	1800	600	730		16270	16500	17280	17150	+550	+670	+340	+1470	32	36	0,22
RO1 18070	1800	700	730		17020	17260	18080	18000	+600	+670	+340	+1470	36	40	0,25
RO1 18080	1800	800	730		17300	17550	18430	18380	+630	+670	+340	+1470	40	45	0,28
RO1 18090	1800	900	730		19830	20090	21000	20940	+670	+670	+340	+1470	44	50	0,33
RO1 200100	2000	1000	730		21200	21510	22560	22400	+810	+670	+340	+1550	45	50	0,4
RO1 220100	2200	1000	730		21520	21850	22910	22710	+830	+670	+340	+1610	55	61	0,41
RO3 120			730	1200	16450	16640	17470	17040	+540	+530	+340	----	27	32	0,17
RO3 130			730	1300	17300	17490	18380	17940	+600	+530	+340	----	33	38	0,22
RO6 14056V	1400	500/600	730		13750	13930	14680	14440	+320	+590	+340	+1230	22	27	0,16
RO6 14067V	1400	600/700	730		14390	14590	15420	15070	+360	+590	+340	+1230	25	30	0,2
RO6 14078V	1400	700/800	730		14590	14800	15620	15270	+370	+590	+340	+1230	28	33	0,22
RO6 14056H	1400	500/600	730		13750	13930	14680	14440	+320	+590	+340	+1230	22	27	0,16
RO6 14067H	1400	600/700	730		14390	14590	15420	15070	+360	+590	+340	+1230	25	30	0,2
RO6 14078H	1400	700/800	730		14590	14800	15620	15270	+370	+590	+340	+1230	48	33	0,22
RO6E 10050	930/1000	500	730		12360	12540	13200	12880	+250	+540	+340	----	19	24	0,15
RO6E 12060	1115/1200	600	730		12540	12720	13440	13120	+270	+540	+340	----	22	27	0,17
RO6E 14070	1300/1400	700	730		14080	14270	15110	14760	+360	+590	+340	----	28	33	0,22

Information

Artno	H = Höjd/ A = Uppfälld skiva	H = Höjd/ A = Uppfälld skiva	B	C	U		X
	H = Height/ A = Table top raised mm	H = Height/ A = Table top raised mm			Avstånd från golv till under- kant bordsskiva		
	H730	H900			H730	H900	
RO1 12050	730/995	900/1070	1120	475	710	880	540
RO1 12060	730/1045	900/1215	1120	475	710	880	540
RO1 12070	730/1095	900/1265	1120	575	710	880	640
RO1 14050	730/995	900/1070	1320	475	710	880	540
RO1 14060	730/1045	900/1215	1320	475	710	880	540
RO1 14070	730/1095	900/1265	1320	575	710	880	640
RO1 14080	730/1145	900/1315	1320	575	710	880	640
RO1 14090	730/1195	900/1365	1320	675	710	880	740
RO1 16080	730/1145	900/1315	1320	575	710	880	640
RO1 18050	730/995	900/1070	1720	475	710	880	540
RO1 18060	730/1045	900/1215	1720	475	710	880	540
RO1 18070	730/1095	900/1265	1720	575	710	880	640
RO1 18080	730/1145	900/1315	1720	575	710	880	640
RO1 18090	730/1195	900/1365	1720	675	710	880	740
RO1 200100	730/1245	900/1415	1720	675	710	880	740
RO1 220100	730/1245	900/1415	1720	675	710	880	740
RO3 120	730/1345	900/1515	740	675	710	880	740
RO3 130	730/1395	900/1565	920	675	710	880	740
RO6 14056V	730/1045	900/1215	1320	475	710	880	540
RO6 14067V	730/1095	900/1265	1320	475	710	880	540
RO6 14078V	730/1145	900/1265	1320	575	710	880	640
RO6 14056H	730/1045	900/1215	1320	475	710	880	540
RO6 14067H	730/1095	900/1265	1320	475	710	880	540
RO6 14078H	730/1145	900/1265	1320	575	710	880	640
RO6E 10050	730/995	900/1070	740	475	710	880	540
RO6E 12060	730/1045	900/1215	920	475	710	880	540
RO6E 14070	730/1095	900/1265	1120	575	710	880	640

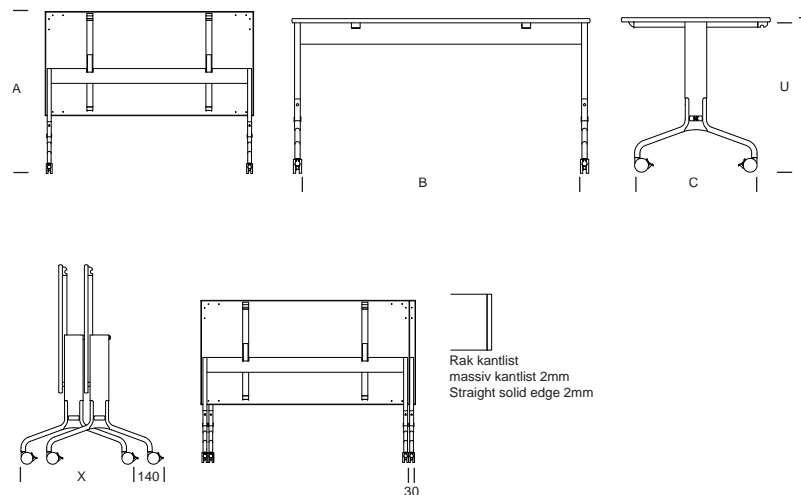

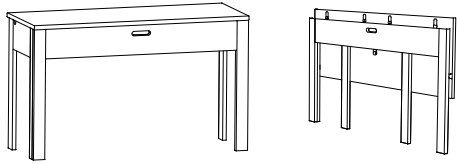

### Fällbord.

Bordsskivan och sargen av trälamell med faner i ek, björk, ask, standardbetset på ask och vitpigmenterad ek och ask. Alternativt högtryckslaminat ek, björk, ask, vit eller svart matt laminat och svart desktop. Ben i massivt trä av ek, björk och ask. Borden kan kopplas samman på kort- och långsida med hjälp av elastiska band som är standard. Bordet är 66mm ihopfällt. Bordet levereras monterat.

### Folding table.

The tabletop and rim are made of blockboard with veneers in oak, birch, ash, standard stain on ash and white glazed on oak and ash. Table top is also available in High Pressure Laminate of oak, birch, ash, white or black matte laminate and black desktop. The legs are made of solid wood in oak, birch and ash. The tables can be linked together with the help of elastic straps that are standard. The table is 66mm when it folded. The table comes pre-assembled.

### Artno

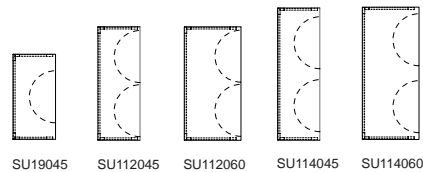

### Tillbehör Accessories



### PRV

**Vagn.** Låsbara hjul. Handtag monteras på långsida. Plats för 8 bord.  
**Trolley.** Lockalbe castors. Handle mounted on long side. Number of tables 8 pcs.

Study SEK								Extra SEK						
Artno	Längd Length mm	Bredd Width mm	Höjd Height mm	Top Faner Veneer Ben Legs .10 ek oak .20 björk birch .30 ask ash	Top Vit White Laminate Ben Legs .61 ek oak .62 björk birch .63 ask ash	Top Svart Black Laminate Ben Legs .65 ek oak .66 björk birch .67 ask ash  Top laminate Ben Legs .71 ek oak .72 björk birch .73 ask ash	Top Svart Black Desktop Ben Legs .91 ek oak .92 björk birch .93 ask ash	Standardbets på ask Standard stain on ash  Vitpigment ek ask White glazed oak ash	Avstånd mellan ben Distance between legs mm	Ihopfällt Folding mm	Vikt netto Weight net kilos	Vikt brutto Weight gross kilos	Volym Volume	
SU19045	900	450	725	8850	8930	9560	9170	+1330	853	66	13	19	0,07	
SU112045	1200	450	725	9330	9520	10200	9870	+1410	1152	66	14	20	0,1	
SU112060	1200	600	725	9740	9930	10680	10320	+1450	1152	66	16	26	0,12	
SU114045	1400	450	725	9900	10080	10880	10590	+1470	1352	66	15	21	0,11	
SU114060	1400	600	725	10380	10600	11410	11110	+1550	1352	66	18	24	0,14	
				<b>Tillbehör Accessories SEK</b>										
PRV vagn trolley	1200	740	1057	7910								30	1,1	



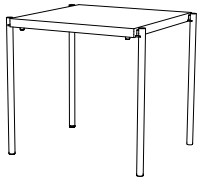

Bord Table

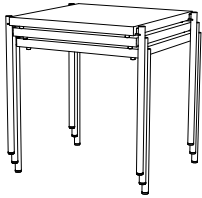

Bord staplingsbart upp till 5st  
Table stackable up to 5 pcs

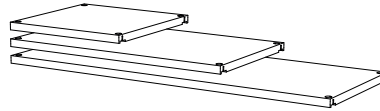

Kopplings-skiva Connecting table top

### Bord stapelbart och kopplingskivor.

Bordsskivor och kopplingskivor tillverkas i en ramkonstruktion med toppskiva av faner i ek, björk, ask, standardbetsar på ask och vitpigmenterad ek och ask. Alternativt högtryckslaminat ek, björk, ask, vit eller svart matt laminat och svart desktop. Vid laminat eller desktop väj kantlist av trä, vit eller svart plast. På undersidan sitter det en ljudabsorberande skiva med kläm- och stapelskydd. Borden är staplingsbara. Ben i vit (RAL9016 G130) eller svart (RAL9017 G130) pulverlackerat stål med filltass. Kopplingskivor kan förvaras på vagn eller hängas upp på vägg. Borden levereras omonterat. Benen skruvas fast under bordsskivan.

### Table stackable and connection table top.

All tabletops and connecting tabletops are made of framed construction with tops in veneers of oak, birch, ash, standard stain on ash and white glazed on oak and ash. Table top is also available in High Pressure Laminate of oak, birch, ash, white or black matte laminate and black desktop. Choose edge of wood, white or black plastic when table top is made of laminate or desktop. The underside of each table and connecting tabletops included a sound-absorbent pad, stacking and safety cover. The tables are stackable and the legs come in white (RAL9016 G130) or black powder (RAL9017 G130) coated steel, included felt floor protection. Store connecting tabletops on a trolley or hang them on the wall. The table comes unmounted. The legs are screwed under the table top.

Artno bord table

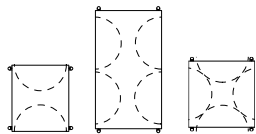

KC16070 KC112570 KC270

Kopplings-skiva Connection table top

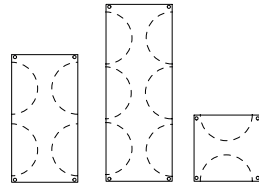

KC112570H KC118570H KC270H

Tillbehör Accessories

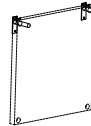

**KCK2s**  
Upphågningsbeslag på vägg.  
Svart metall. 2 kopplingskivor.

**Suspension bracket on wall.**  
Black metal. 2 connecting tabletops.



Kortsida Shortside



Längsida Longside

### PRV Vagn för kopplingskivor.

Låsbara hjul. Handtag monteras på långsida eller kortsida.

**Trolley for connecting table tops.**  
Lockable castors. Handle mounted on long side or short side.

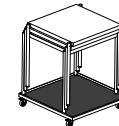

**KCV70**  
Vagn för bord 700x700 eller 700x600. Låsbara hjul, gummimatta. För 5 bord.

**Trolley for table 700x700 or 700x600.**  
Lockable castors, rubber carpet. For 5 tables.



### Kanecct SEK

### Extra SEK

Artno	Längd Length mm	Längd inkl ben Length incl. legs mm	Bredd Width mm	Höjd Height mm	Top Faner Veneer .10 ek oak .20 björk birch .30 ask ash .60 vit white laminate	.61 Top Svart black Laminate Top Laminate .71 ek oak .72 björk birch .73 ask ash	.90 Top Svart black Desktop	Standardbets på ask Standard stain on ash	Vikt netto Weight net kilos	Vikt brutto Weight gross kilos	Volym Volume
KC16070	600	684	700	725	8850	9560	9170	+800	12	19	0,1
KC112570	1250	1334	700	725	10270	11240	10880	+1140	17	24	0,2
KC270	700	784	700	725	9020	9760	10610	+930	13	20	0,11
KC112570H	1250		700		7280	8230	7890	+1140	11	18	0,02
KC118570H	1850		700		8680	9840	9580	+1360	16	23	0,02
KC270H	700		700		6000	6730	6340	+930	7	14	0,01
					<b>Tillbehör Accessories SEK</b>						
KCK2s upph.beslag suspen.bracket					870/2pcs						
PRV vagn upph.skiva troelly connect	1200		740	1057	7910					30	1,1
KCV70 vagn för bord troelly for tables	830		830	140	6340					20	0,2

# CAP BORD TABLE Roger Persson 2014

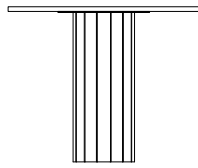

Pelare Pedestal ø290mm

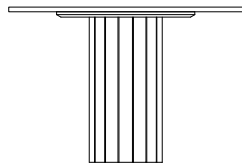

Pelare Pedestal ø350mm

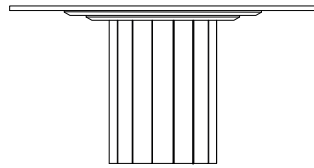

Pelare Pedestal ø490mm

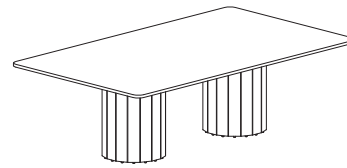

Rektangulär Rectangulare

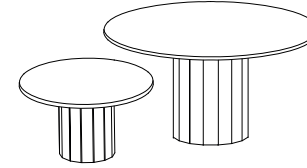

Rund Round

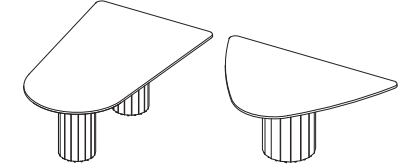

Oregelbunden form Irregular shape

## Pelarbord.

Pelare i massiv trä. Skivan, tjocklek 22mm, kan väljas mellan faner och vissa storlekar i massivt trä. Träslag är ek, björk, ask, standardfärger, standardbetsar på ask och vitpigmenterad ek och ask. Alternativt högtryckslaminat (ek, björk, ask, vit, svart) samt svart desktop. Vid val av betsfärg rekommenderas skivan i faner. Special mått och andra utförande efter förfrågan. Stabilitet och balans uppnås genom rätt mängd av stenmjöl i pelaren, beroenden på bordskivans storlek.

Bordet levereras ommonterat. Pelaren skruvas fast under bordsskivan. Vid order ange höjd och utförande.

## Pedestal table.

Pedestal in solid wood. Tabletop, thickness 22mm, in a choice of veneer or some dimensions in solid wood. Table come in oak, birch, ash, standard colors, standard stain on ash and white glazed on oak and ash. Table top is also available in High Pressure Laminate (oak, birch, ash, white, black) and black desktop. For stained finishes, we recommend a veneered top. Please enquire for details of non-standard sizes and other finishes.

The stability and balance of the construction is achieved by adding just the right amount of stone dust inside the pillar, according to the size of the tabletop. The table comes unmounted. The pedestal screwed under the table top. When ordering state height.

Artno

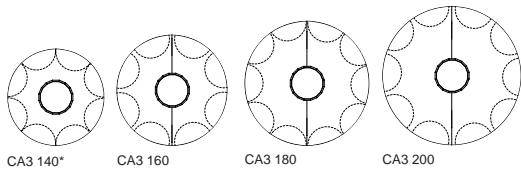
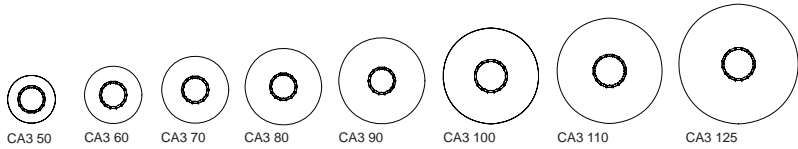
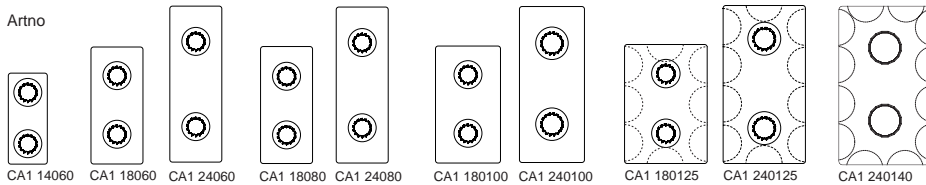

Tillbehör Accessories	Artno	Diam mm		SEK
	TKB7C	ø115	<b>Twist. Lock borstat rostfritt stål. 2 Eluttag. Kan endast placeras i skiva ovanför pelare. Lock borstat rostfritt stål. 2m kabel. Gäller för SE, NO, FIN, DE, NL.</b> Twist. Brushed stainless lid. 2 Electrical. Placed only on table top above pedestal. 2m cables. For SE, NO,FIN, DE, NL.	3760
	TKB11C	ø57	<b>Powerdot Mini. Placeras i skiva ovanför pelare alternativt i pelare lika illustration. 1 eluttag, svart, 1,5m kabel. Gäller för SE,NO,FIN,DE,NL.</b> Powerdot Mini. Placed on top above pedestal alternative in the pedestal as the illustration. 1electrical black, 1,5m cable. For SE,NO,FIN,DE,NL	2040
	TKB12C	ø57	<b>Powerdot Mini. Placeras i skiva ovanför pelare alternativt i pelare lika illustration. USB A laddare inkl. 2 portar, svart, 1,5m kabel. Gäller för SE,NO,FIN,DE,NL.</b> Powerdot Mini. Placed on top above pedestal alternative in the pedestal as the illustration. USB A charging incl. 2 ports, black, 1,5m cable. For SE,NO,FIN,DE,NL	2420
	TKB19C	ø57	<b>Powerdot Mini. Placeras i skiva ovanför pelare alternativt i pelare lika illustration. USB C laddare inkl. 2 portar, svart, 1,25m kabel. Gäller för SE,NO,FIN,DE,NL.</b> Powerdot Mini. Placed on top above pedestal alternative in the pedestal as the illustration. USB C charging incl. 2 ports, black, 1,25m cable. For SE,NO,FIN,DE,NL	2710
	TKB20C	ø70	<b>Powerdot Midi. Kan endast placeras i skiva ovanför pelare. 1 eluttag, 1 USB C laddare, svart, 1,25m kabel. Gäller för SE,NO,FIN,DE,NL.</b> Powerdot Midi. Placed only on table top above pedestal. 1 electrical, 1 USB C charging, black, 1,25m cable. For SE,NO,FIN,DE,NL	2710
	TKB15C	ø160 D 105	<b>Kabelgenomföring med elbrunn. Lösa lock. Exkl. eluttag. Placeras i skiva ovanför pelare ø350mm.</b> Cable slot with box. For socket and leads. Loose covers. Excl. electrical equipment. Placed on top above pedestal ø350mm.	4010
	TKB16C	ø270 D 105	<b>Kabelgenomföring med elbrunn. Lösa lock. Exkl. eluttag. Placeras i skiva ovanför pelare ø490mm</b> Cable slot with box. For socket and leads. Loose covers. Excl. electrical equipment. Placed on top above pedestal ø490mm.	4010

\* ek, björk, ask laminat = delad skiva  
oak, birch, ash laminate = divided top

SENAB

**22% RABATT SKA DRAS AV PÅ ANGIVNA PRISER**

## Cap Bord Table SEK

## Extra SEK

Artno	Längd Length mm	Bredd Width mm	Höjd Height mm	Diam på pelare Diam on pedestal mm	Top Faner Veneer Pelare Pedestal .10 ek oak .20 björk birch .30 ask ash .50 lack color	Top Vit White Laminat Pelare Pedestal .61 ek oak .62 björk birch .63 ask ash	Top Svart Black Laminat Pelare Pedestal .65 ek oak .66 björk birch .67 ask ash  Top Laminat Pelare Pedestal .71 ek oak .72 björk birch .73 ask ash	Top Svart Black Desktop Pelare Pedestal .91 ek oak .92 björk birch .93 ask ash	Standardbets på ask skiva Standard stain on ash top  Vitpigment ek ask White glazed oak ash	Standardbets på ask pelare Standard stain on ash pedestal  Vitpigment ek ask White glazed oak ash	Massiv skiva, klarlack Solid top, clear lacquer	Vikt netto Weight net kilos	Vikt brutto Weight gross kilos	Volym Volume
CA1 14060	1400	600	400,460,550	290	17080	17210	17770	17630	+540	+1170	+2150	106/106/108	138	1,54
CA1 14060	1400	600	730	290	21630	21770	22320	22190	+540	+1620	+2150	128	170	1,54
CA1 14060	1400	600	900,1100	290	24310	24440	24990	24860	+540	+1900	+2150	156/166	210	1,54
CA1 18060	1800	600	400,460,550	290	17950	18100	18740	18580	+630	+1170	+2500	120/120/122	152	1,92
CA1 18060	1800	600	730	290	22500	22660	23300	23140	+630	+1620	+2500	142	182	1,92
CA1 18060	1800	600	900,1100	290	25180	25330	25970	25810	+630	+1900	+2500	170/194	234	1,92
CA1 24060	2400	600	730	290	24580	24790	25640	25430	+840	+1620	+4170	156	196	1,92
CA1 24060	2400	600	900,1100	290	27250	27460	28310	28100	+840	+1900	+4170	186/208	248	1,92
CA1 18080	1800	800	730	290	24580	24790	25640	25430	+840	+1620	+4170	184	224	1,92
CA1 18080	1800	800	900,1100	290	27250	27460	28310	28100	+840	+1900	+4170	142/164	195	1,92
CA1 24080	2400	800	730	290	26050	26310	27330	27070	+980	+1620	+4900	224	264	1,92
CA1 24080	2400	800	900,1100	290	28730	28980	30000	29740	+980	+1900	+4900	198/220	260	1,92
CA1 180100	1800	1000	730	350	28870	29110	30040	29810	+920	+1970	+4590	198	238	1,92
CA1 180100	1800	1000	900,1100	350	32270	32500	33430	33200	+920	+2310	+4590	153/175	210	1,92
CA1 240100	2400	1000	730	350	31930	32230	33460	33160	+1220	+1970	+6120	234	280	2,30
CA1 240100	2400	1000	900,1100	350	35320	35630	36860	36550	+1220	+2310	+6120	218/240	275	2,30
CA1 180125	1800	1250	730	350	32690	33020	34330	34000	+1300	+1970	----	214	255	2,08
CA1 180125	1800	1250	900,1100	350	36080	36410	37730	37400	+1300	+2310	----	163/185	220	2,08
CA1 240125	2400	1250	730	350	34990	35380	36950	36560	+1530	+1970	----	254	295	3,0
CA1 240125	2400	1250	900,1100	350	38380	38770	40340	39950	+1530	+2310	----	233/255	300	3,0
CA1 240140	2400	1400	730	490	48940	49480	51640	51100	+2150	+2420	----	370	400	3,2
CA1 240140	2400	1400	900,1100	490	52210	52750	54910	55040	+2150	+2750	----	390/400	430/450	3,2

# CAP BORD TABLE Roger Persson 2014



## Cap Bord Table SEK

## Extra SEK

Artno	Diam mm	Höjd Height mm	Diam på pelare Diam on pedestal mm	Top Faner Veneer Pelare Pedestal .10 ek oak .20 björk birch .30 ask ash .50 lack color	Top Vit White Laminate Pelare Pedestal .61 ek oak .62 björk birch .63 ask ash	Top Svart Black Laminate Pelare Pedestal .65 ek oak .66 björk birch .67 ask ash  Top Laminate Pelare Pedestal .71 ek oak .72 björk birch .73 ask ash	Top Svart Black Desktop Pelare Pedestal .91 ek oak .92 björk birch .93 ask ash	Standardbets på ask skiva Standard stain on ash top  Vitpigment ek ask White glazed oak ash	Standardbets på ask pelare Standard stain on ash pedestal  Vitpigment ek ask White glazed oak ash	Massiv skiva, klarlack Solid top, clear lacquer	Vikt netto Weight net kilos	Vikt brutto Weight gross kilos	Volym Volume
<b>Rund Round</b>													
CA3 50	ø500	400,460,550	290	8430	8500	8800	8720	+250	+580	+1030	38/38/39	73/73/74	0,1
CA3 50	ø500	730	290	10710	10780	11080	11000	+250	+820	+1030	50	85	0,13
CA3 50	ø500	900,1100	290	12040	12120	12410	12340	+250	+940	+1030	64/80	100/115	0,2
CA3 60	ø600	400,460,550	290	8990	9070	9410	9330	+320	+580	+1250	45/45/46	80/80/81	0,1
CA3 60	ø600	730	290	11270	11350	11690	11610	+320	+820	+1250	52	87	0,13
CA3 60	ø600	900,1100	290	12600	12690	13030	12940	+320	+940	+1250	66/83	101/118	0,2
CA3 70	ø700	400,460,550	290	9390	9490	9870	9770	+350	+580	+1420	47/52/53	82/87/88	0,1
CA3 70	ø700	730	290	11670	11770	12150	12050	+350	+820	+1420	64	99	0,13
CA3 70	ø700	900,1100	290	13010	13100	13480	13390	+350	+940	+1420	78/89	113/124	0,2
CA3 80	ø800	400,460,550	290	10470	10590	11060	10940	+470	+580	+1840	48/56/58	83/91/93	0,11
CA3 80	ø800	730	290	12750	12870	13330	13220	+470	+820	+1840	66	101	0,13
CA3 80	ø800	900,1100	290	14090	14200	14670	14550	+470	+940	+1840	84/96	119/131	0,17
CA3 90	ø900	460,550	350	13060	13190	13700	13570	+500	+820	+2230	58/66/68	85/93/95	0,14
CA3 90	ø900	730	290	13080	13210	13720	13590	+500	+820	+2230	68	103	0,16
CA3 90	ø900	900,1100	290	14420	14540	15050	14920	+500	+940	+2230	84/96	119/131	0,18
CA3 100	ø1000	460,550	350	14230	14380	15020	14860	+610	+820	+2760	78/80	108/110	0,19
CA3 100	ø1000	730	350	15960	16120	16760	16600	+610	+990	+2760	90	125	0,21
CA3 100	ø1000	900,1100	350	17660	17820	18450	18300	+610	+1160	+2760	111/119	146/154	0,23
CA3 110	ø1100	400,460,550	490	16610	16770	17410	17250	+640	+1050	+2780	71/83/85	105/112/115	1,25
CA3 110	ø1100	730	350	16020	16180	16810	16650	+640	+990	+2780	97	132	1,25
CA3 110	ø1100	900,1100	350	17710	17870	18510	18350	+640	+1160	+2780	111/127	146/162	1,25
CA3 125	ø1250	400,460,550	490	18000	18190	18950	18760	+750	+1050	+3780	81/93/95	107/115/117	1,45
CA3 125	ø1250	730	350	17410	17600	18360	18170	+750	+990	+3780	119	154	1,45
CA3 125	ø1250	900,1100	350	19100	19290	20060	19860	+750	+1160	+3780	121/135	156/170	1,45
CA3 140*	ø1400	730	490	23710	23970	24980	24730	+1000	+1210		142	160	1,21
CA3 140*	ø1400	900, 1100	490	25340	25600	26620	26360	+1000	+1370		132/146	147/161	1,21
CA3 160	ø1600	730	490	28890	29230	30630	30280	+1400	+1210		148	170	1,32
CA3 160	ø1600	900, 1100	490	30520	30870	32270	31920	+1400	+1370		156/170	176/190	1,32
CA3 180	ø1800	730	490	33050	33500	35280	34830	+1750	+1210		168	193	1,32
CA3 180	ø1800	900, 1100	490	34680	35130	36910	36460	+1750	+1370		182/196	207/221	1,42
CA3 200	ø2000	730	490	38190	38730	40890	40350	+2130	+1210		194	224	1,42
CA3 200	ø2000	900, 1100	490	39820	40360	42530	41990	+2130	+1370		208/222	238/252	1,42

\* ek, björk, ask laminat = delad skiva  
\* oak, birch, ash laminate = divided top

# SE NAB

## 22% RABATT SKA DRAS AV PÅ ANGIVNA PRISER

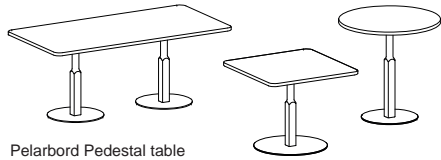

Pelarbord Pedestal table

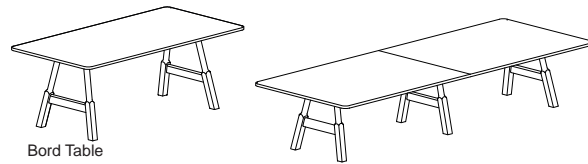

Bord Table

**Pelarbord.** Rektangulär, kvadratisk och rund skiva fanerad MDF, klarlack. Faner i ek, ask, standardbetser på ask och vitpigmenterad ek eller ask. Alternativt högtryckslaminat i vit, svart matt, ek, ask och svart desktop. Pelaren är i massiv trä med stälkärna. Fotplattan är i metall och pulverlack av vit (RAL 9016) svart (RAL 9005), grå (RAL 9006/07) och försedd med filtassar. Bordet levereras ommonterat. Skiva skruvas på pelare. Bordskivan, pelare och fotplatta är separerbara och enkla att fräscha upp efter många års användning. Som tillbehör till rektangulär bordsskiva (ej kvadratisk, rund) finns eluttag. Vid order ange artikelnummer, höjd och utförande av fotplatta.

**Bord.** Rektangulär skiva i fanerad trälamell, klarlack. Faner i ek, ask, standardbetser på ask och vitpigmenterad ek eller ask. Alternativt högtryckslaminat i vit, svart matt, ek, ask och svart desktop. Benstativet och sargen i massiv trä och försedd med ställfötter. Bordet levereras ommonterat. Bengavel, sargen och skiva skruvas samman. Som tillbehör till bordet finns olika eluttag. Vid order ange artikelnummer, höjd och utförande.

**Pedestal table.** Rectangular, square and round top, veneered MDF, clear lacquer. Veneer in oak, ash, standardstain on ash and white glazed oak or ash. Table top is also available in High Pressure Laminate of oak, ash, white or black matte and black desktop. The pedestal is in solid wood with a steel core. The table footplate is in metal, powder lacquered in white (RAL 9016), black (RAL 9005) or grey (RAL 9006/07) and has felt floor protectors. Table top, pedestal and footplate are detachable, so it is simple to freshen them up after many years' faithful service. Electrical outlets are available only for rectangular table top (not round and square). When ordering state article number, height, finish and finish of footplate.

**Table.** Rectangular table top veneered blockboard, clear lacquer. Veneer in oak, ash, standardstain on ash and white glazed oak or ash. Table top is also available in High Pressure Laminate of oak, ash, white or black matte laminate and black desktop. The underframe and legs are in solid wood with adjustment screws on the feet. The table is supplied unassembled. Various power outlets are available as optional extras. Please enquire for details of non-standard sizes and other finishes. When ordering state article number, height and finish.

Artno Pelarbord Pedestal table

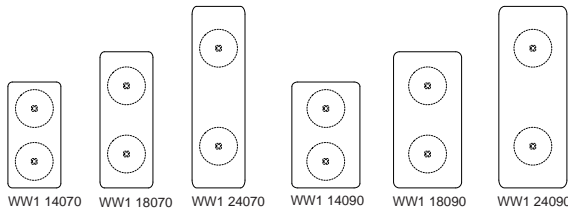

WW1 14070 WW1 18070 WW1 24070 WW1 14090 WW1 18090 WW1 24090

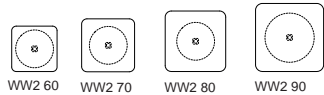

WW2 60 WW2 70 WW2 80 WW2 90

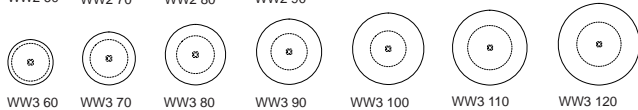

WW3 60 WW3 70 WW3 80 WW3 90 WW3 100 WW3 110 WW3 120

Artno Bord Table

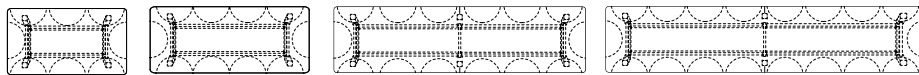

WW1 180100 WW1 240100 WW1 380100 WW1 480100

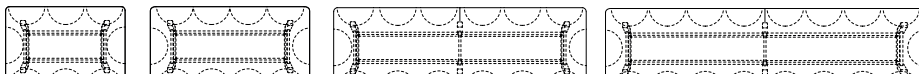

WW1 180120 WW1 240120 WW1 380120 WW1 480120

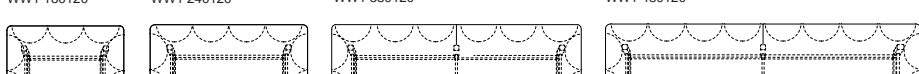

WW1 180140 WW1 240140 WW1 380140 WW1 480140

Tillbehör Accessories	Artno	Dimension		SEK
	TKB4WW	L282 B127 D100	<b>Kabelgenomföring med elbrunn, lösa lock. Svart MDF botten L750 TJ12mm, monteras centrerat under kabelgenomföringen. Exkl. eluttag. Endast för Bord.</b> Cable slot, for socket and leads. Loose covers. Black MDF bottom L750 and thickness 12mm placed centered under the cable slot. Excl. electrical equipment. Only for Table.	2200
	TKB14WW	L402 B127 D100	<b>Kabelgenomföring med elbrunn, lösa lock. Svart MDF botten L750 TJ12mm, monteras centrerat under kabelgenomföringen. Exkl. eluttag. Endast för Bord.</b> Cable slot, for socket and leads. Loose covers. Black MDF bottom L750 and thickness 12mm placed centered under the cable slot. Excl. electrical equipment. Only for Table.	2320
	TKB15WW	L600 B140 D100	<b>Axessline Duo60II från Kondator. Metall lock, färg svart, vit, silver. Svart MDF botten L750 TJ12mm, monteras centrerat under kabelgenomföringen. Exkl. eluttag. Endast för Bord.</b> Axessline Duo60II from Kondator. Metal lid col. black, white, silver. Black MDF bottom L750 and thickness 12mm placed centered under the cable slot. Excl. electrical equipment. Only for Table.	4030
	TKB7	ø115	<b>Twist. Lock borstat rostfritt stål. 2 Eluttag. 2m kabel. Gäller för SE,NO,FIN,DE, NL. Endast för Rektangulära pelarbord och Bord.</b> Twist. Brushed stainless lid. 2 Electrical. 2m cables. For SE, NO, FIN, DE, NL. Only for Rectangulare Pedestal table and Table	2590
	TKB11	ø57	<b>Powerdot Mini. 1 eluttag, svart, 1,5m kabel. Gäller för SE,NO,FIN,DE,NL. Endast för Rektangulära Pelarbord och Bord.</b> Powerdot Mini. 1 electrical black, 1,5m cable. For SE,NO,FIN,DE,NL. Only for rectangular Pedestal table and Table.	750
	TKB12	ø57	<b>Powerdot Mini. USB A laddare inkl. 2 portar, svart, 1,5m kabel. Gäller för SE,NO,FIN,DE,NL. Endast för Rektangulära pelarbord och Bord.</b> Powerdot Mini. USB A charging incl. 2 ports, black, 1,5m cable. For SE,NO,FIN,DE,NL. Only for rectangular Pedestal table and Table.	1130
	TKB19	ø57	<b>Powerdot Mini. USB C laddare inkl. 2 portar, svart, 1,25m kabel. Gäller för SE,NO,FIN,DE,NL. Endast för Rektangulär pelarbord och Bord.</b> Powerdot Mini. USB C charging incl. 2 ports, black, 1,25m cable. For SE,NO,FIN,DE,NL. Only for rectangular Pedestal table and Table.	1280
	TKB20	ø70	<b>Powerdot Midi. 1 eluttag, 1 USB C laddare, svart 1,25m kabel. Gäller för SE,NO, FIN,DE,NL. Endast för Rektangulär pelarbord och Bord.</b> Powerdot Midi. 1 electrical, 1 USB C charging, black, 1,25m cable. For SE,NO,FIN,DE,NL. Only for rectangular Pedestal table and Table.	1280



Artno	Längd Length mm	Bredd Width mm	Diam. mm	Höjd Height mm	Top Faner Veneer Pelare Pedestal .10 ek oak .30 ask ash	Top Vit White Laminate Pelare Pedestal .61 ek oak .63 ask ash	Top Svart Black Laminate Pelare Pedestal .65 ek oak .67 ask ash	Top Svart Black Desktop Pelare Pedestal .91 ek oak .93 ask ash	Standardbets på ask skiva Standard stain on ash top Vitpigment ek ask White glazed oak ash	Standardbets på ask pelare/ben Standard stain on ash pedestal/legs Vitpigment ek ask White pigment oak ash	Vikt brutto Weight gross kilos	Volym Volume
<b>PELARBORD PEDESTAL Rektangulär Rectangulare</b>												
WW1 14070	1400	700		730, 900, 1050	19660	19860	20720	20380	+1060	+1260	76	0,51/0,56/0,61
WW1 18070	1800	700		730, 900, 1050	21400	21630	22540	22300	+1330	+1260	84	0,53/0,58/0,63
WW1 24070	2400	700		730, 900, 1050	21960	22220	23800	23210	+1410	+1260	96	0,56/0,61/0,66
WW1 14090	1400	900		730, 900, 1050	20570	20790	21840	21320	+1200	+1260	84	0,53/0,58/0,63
WW1 18090	1800	900		730, 900, 1050	22470	22690	23820	23420	+1490	+1260	96	0,56/0,61/0,66
WW1 24090	2400	900		730	24210	24490	26090	25510	+1750	+1260	102	0,6/0,65/0,7
<b>Kvadratisk Square</b>												
WW2 60	600	600		730, 900, 1050	10180	10250	10720	10480	+580	+630	36	0,25/0,3/0,35
WW2 70	700	700		730, 900, 1050	10750	10840	11490	11100	+670	+630	38	0,26/0,31/0,36
WW2 80	800	800		730, 900, 1050	11250	11340	12060	11620	+740	+630	42	0,27/0,32/0,37
WW2 90	900	900		730	12590	12710	13530	12970	+830	+630	46	0,28/0,33/0,38
<b>Rund Round</b>												
WW3 60			ø600	730, 900, 1050	9810	9880	10350	10120	+530	+630	35	0,25/0,3/0,35
WW3 70			ø700	730, 900, 1050	10460	10530	11180	10790	+630	+630	36	0,26/0,31/0,36
WW3 80			ø800	730, 900, 1050	10880	10970	11690	11250	+690	+630	40	0,27/0,32/0,37
WW3 90			ø900	730, 900, 1050	11490	11600	12420	11860	+770	+630	43	0,28/0,33/0,38
WW3 100			ø1000	730, 900, 1050	12330	12480	13280	12730	+910	+630	47	0,29/0,34/0,39
WW3 110			ø1100	730	13660	13830	14650	14100	+990	+630	59/62/65	0,46/0,54/0,61
WW3 120			ø1200	730	14420	14560	15470	14870	+1110	+630	59/66/69	0,48/0,56/0,63
<b>BORD Rektangulär TABLE Rectangulare</b>												
WW1 180100	1800	1000		730, 900	28750	29020	30100	29830	+1440	+2870	71/75	0,31/0,35
WW1 240100	2400	1000		730, 900	32340	32680	35200	33690	+1620	+3230	115/119	0,36/0,4
WW1 380100	3800	1000		730, 900	52750	53290	55450	54910	+2640	+5280	178/184	0,56/0,46
WW1 480100	4800	1000		730, 900	60780	61470	64230	63540	+3040	+6070	218/224	0,65/0,71
WW1 180120	1800	1200		730, 900	30070	30370	31560	31260	+1510	+3010	81/85	0,33/0,37
WW1 240120	2400	1200		730, 900	35660	36060	37680	37280	+1780	+3560	105/109	0,38/0,42
WW1 380120	3800	1200		730, 900	58020	58670	61260	60610	+2900	+5800	168/174	0,58/0,48
WW1 480120	4800	1200		730, 900	71180	72070	75630	74740	+3560	+7110	208/214	0,67/0,73
WW1 180140	1800	1400		730, 900	34210	34580		35710	+1710	+3420	91/95	0,35/0,39
WW1 240140	2400	1400		730, 900	41160	41680		43220	+2060	+4110	117/121	0,38/0,42
WW1 380140	3800	1400		730, 900	63280	64050		66300	+3170	+6330	184/190	0,63/0,69
WW1 480140	4800	1400		730, 900	74100	75050		77980	+3700	+7410	228/234	0,66/0,79

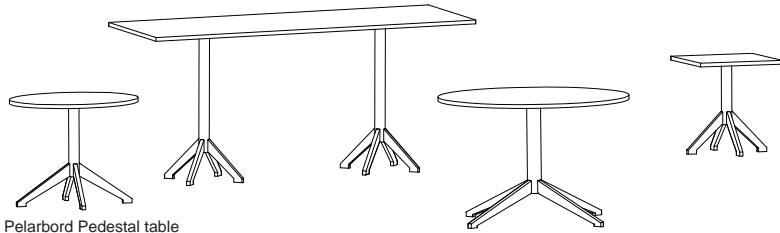

Pelarbord Pedestal table

**Pelarbord "Kryssfot".**

Rektangulär skiva = fanerad trälamell, klarlack.  
 Kvadratisk, rund och oval skiva = fanerad MDF, klarlack.  
 Faner i ek, björk, ask, standardfärger, standardbetser på ask eller vitpigmenterad ek och ask. Alternativt är högtryckslaminat ek, björk, ask, vit eller svart samt svart desktop. Specialmått och andra utförande efter förfrågan.  
 Pelare och fotkryssset, med en karaktäristisk klack nertill är i massivt trä med ställfötter. Bordet levereras omonterat. Pelaren skruvas fast under bordsskivan. Tillval endast till rektangulära bord är eluttag. Vid order ange utförande och höjd.

**Pedestal table "4-star base".**

Rectangulare top = veneered blockboard, clear lacquer.  
 Square, round and oval top = veneered MDF, clear lacquer.  
 Veneer in oak, birch, ash, standard colors, standard stains on ash or white glazed on oak or ash. Table top is also available in High Pressure Laminate of oak, birch, ash, white or black and black desktop.  
 Please enquire for details of non-standard sizes and finishes. The pedestal and feet with characteristic heels at the bottom are in solid wood with adjustable screws. The table comes unmounted. The pedestal screwed under the table top. When ordering state finish and height.

Artno Pelarbord Pedestal table

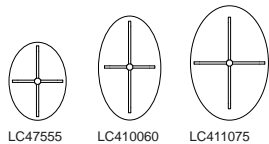
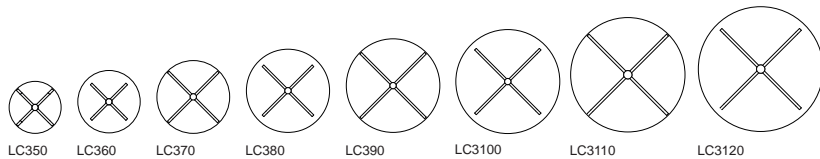
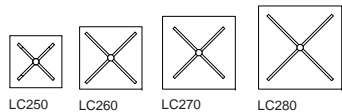
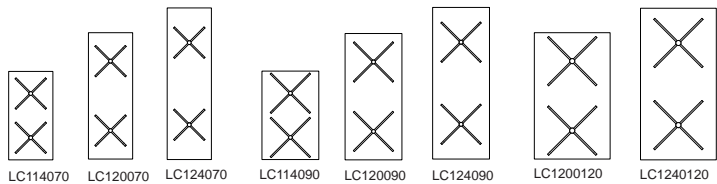

Tillbehör Accessories	Artno	Diam mm		SEK
	TKB4		<b>Kabelgenomföring med elbrunn, svart. Ett löst lock. Exkl. eluttag. Endast för Rektangulära pelarbord.</b> Cable slot with box, black. For socket and leads. One loose covers. Excl. electrical equipment. Only for rectangular Pedestal table.	3100
	TKB7	ø115	<b>Twist. Lock borstat rostfritt stål. 2 Eluttag, 2m kabel. Gäller för SE, NO, FIN, DE, NL. Endast för Rektangulära pelarbord.</b> Twist. Brushed stainless lid. 2 Electrical. 2m cables. For SE, NO, FIN, DE, NL. Only for rectangular Pedestal table.	2590
	TKB11	ø57	<b>Powerdot Mini. 1 eluttag, svart, 1,5m kabel. Gäller för SE,NO,FIN,DE,NL. Endast för Rektangulära pelarbord.</b> Powerdot Mini. 1 electrical black, 1,5m cable. For SE,NO,FIN,DE,NL. Only for rectangular Pedestal table.	750
	TKB12	ø57	<b>Powerdot Mini. USB A laddare inkl. 2 portar, svart, 1,5m kabel. Gäller för SE,NO,FIN,DE,NL. Endast för Rektangulära pelarbord.</b> Powerdot Mini. USB A charging incl. 2 ports, black, 1,5m cable. For SE,NO,FIN,DE,NL. Only for rectangular Pedestal table.	1130
	TKB19	ø57	<b>Powerdot Mini. USB C laddare inkl. 2 portar, svart, 1,25m kabel. Gäller för SE,NO,FIN,DE,NL. Endast för Rektangulära pelarbord.</b> Powerdot Mini. USB C charging incl. 2 ports, black, 1,25m cable. For SE,NO,FIN,DE,NL. Only for rectangular Pedestal table.	1280
	TKB20	ø70	<b>Powerdot Midi. 1 eluttag, 1 USB C laddare, svart 1,25m kabel. Gäller för SE,NO,FIN,DE,NL. Endast för Rektangulära pelarbord.</b> Powerdot Midi. 1 electrical, 1 USB C charging, black, 1,25m cable. For SE,NO,FIN,DE,NL. Only for rectangular Pedestal table.	1280

Artno	Längd Length mm	Bredd Width mm	Diam. mm	Höjd Height mm	Locus SEK					Extra SEK		
					Top Faner Veneer .10 ek oak .20 björk birch .30 ask ash	.50 Top Lack Color	Top Vit White Laminate Pelare Fot Pedestal Foot .61 ek oak .62 björk birch .63 ask ash	Top Svart Black Laminate Pelare Fot Pedestal Foot .65 ek oak .66 björk birch .67 ask ash	Top Svart Black Desktop Pelare Fot Pedesta Foot .91 ek oak .92 björk birch .93 ask ash	Standardbets på ask Standard stain on ash  Vitpigment ek ask White glazed oak ash	Vikt brutto Weight gross kilos	Volym Volume
<b>PELARBORD PEDESTAL</b> Rektangulär Rectangulare												
LC114070	1400	700		550,620,730,900,1100	21040	18180	21230	22100	21750	+3160	34	0,3/0,36/0,4/0,5/0,6
LC120070	2000	700		550,620,730,900,1100	23010	18940	23260	24410	24190	+3430	40	0,3/0,36/0,4/0,5/0,6
LC124070	2400	700		550,620,730,900,1100	24130	20070	24370	25960	25370	+3610	45	0,3/0,36/0,4/0,5/0,6
LC114090	1400	900		550,620,730,900,1100	22150	18600	22440	24040	23450	+3320	37	0,5/0,6/0,7/0,84/1,0
LC120090	2000	900		550,620,730,900,1100	24980	19580	25260	26640	26010	+3750	43	0,5/0,6/0,7/0,84/1,0
LC124090	2400	900		550,620,730,900,1100	28310	20570	28600	30200	29610	+4240	47	0,5/0,6/0,7/0,84/1,0
LC1200120	2000	1200		730	32480	23750	32830	34290	33620	+4880	51	1,0
LC1240120	2400	1200		730	38370	24680	38820	40510	39780	+5770	55	1,0
<b>Kvadratisk Square</b>												
LC250	500	500		550,620,730,900,1100	9510	8460	9560	10050	9810	+1430	10	0,09/0,1/0,12/0,15/0,18
LC260	600	600		550,620,730,900,1100	10360	8880	10440	10900	10680	+1550	15	0,15/0,18/0,2/0,25/0,3
LC270	700	700		550,620,730,900,1100	11670	9020	11760	12410	12020	+1750	17	0,15/0,18/0,2/0,25/0,3
LC280	800	800		550,620,730,900,1100	12090	9480	12180	12920	12470	+1810	19	0,26/0,3/0,34/0,42/0,5
<b>Rund Round</b>												
LC350			ø500	550,620,730,900,1100	9120	8360	9170	9660	9410	+1380	10	0,09/0,1/0,12/0,15/0,18
LC360			ø600	550,620,730,900,1100	9700	8590	9760	10240	9990	+1440	15	0,15/0,18/0,2/0,25/0,3
LC370			ø700	550,620,730,900,1100	10990	8960	11090	11730	11340	+1660	17	0,15/0,18/0,2/0,25/0,3
LC380			ø800	550,620,730,900,1100	11340	9350	11430	12160	11690	+1720	19	0,26/0,3/0,34/0,42/0,5
LC390			ø900	550,620,730,900,1100	11730	9760	11830	12670	12110	+1770	21	0,26/0,3/0,34/0,42/0,5
LC3100			ø1000	550,620,730,900,1100	12910	10260	13050	13850	13310	+1940	23	0,26/0,3/0,34/0,42/0,5
LC3110			ø1100	730	14250	12020	14380	15210	14670	+2130	25	0,5
LC3120			ø1200	730	15400	12380	15560	16460	15860	+2310	27	0,5
<b>Oval</b>												
LC47555	750	550		550,620,730,900,1100	10240	8820	10320	11060	10600	+1530	12	0,2/0,23/0,26/0,4/0,48
LC410060	1000	600		550,620,730,900,1100	10990	9400	11130	11950	11400	+1660	15	0,26/0,29/0,34/0,42/0,5
LC411075	1100	750		550,620,730,900,1100	11800	9850	11960	12770	12230	+1770	18	0,37/0,4/0,48/0,6/0,71

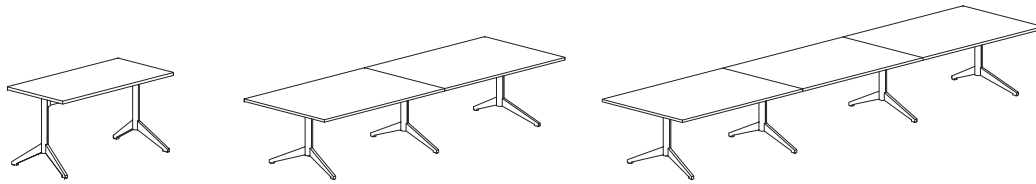

### Bord "T-stativ".



Rektangulär skiva = fanerad trälamell, klarlack. Faner i ek, björk, ask, standardbetser på ask eller vitpigmenterad ek och ask. Alternativt är högtryckslaminat (ek, björk, ask, vit, svart) samt svart desktop. Specialmått och andra utförande efter förfrågan. Tillval är eluttag där kabel förs genom pelaren och ner till golvet.  
Pelare och fot, med en karaktäristisk klack nertill är i massivt trä med ställfötter. Bordet levereras omonterat. Pelaren skruvas fast under bordsskivan. Vid behov kan bordsskiva och ben enkelt demonteras med enkla handverktyg. Vid order ange utförande.

### Table "T-base".

Rectangular top = veneered blockboard, clear lacquer. Veneer in oak, birch, ash, standard stains on ash or white glazed on oak or ash. Table top is also available in High Pressure Laminate of oak, birch, ash, white or black laminate and black desktop. An option is an electrical outlet where the cable is pulled through the column and down to the floor. Please enquire for details of non-standard sizes and finishes. The pedestal and feet with characteristic heels at the bottom are in solid wood with adjustable screws. The table comes unmounted. The pedestal screwed under the table top. The tabletop and leg can easily be dismantled with hand tools. When ordering state article number and finish.

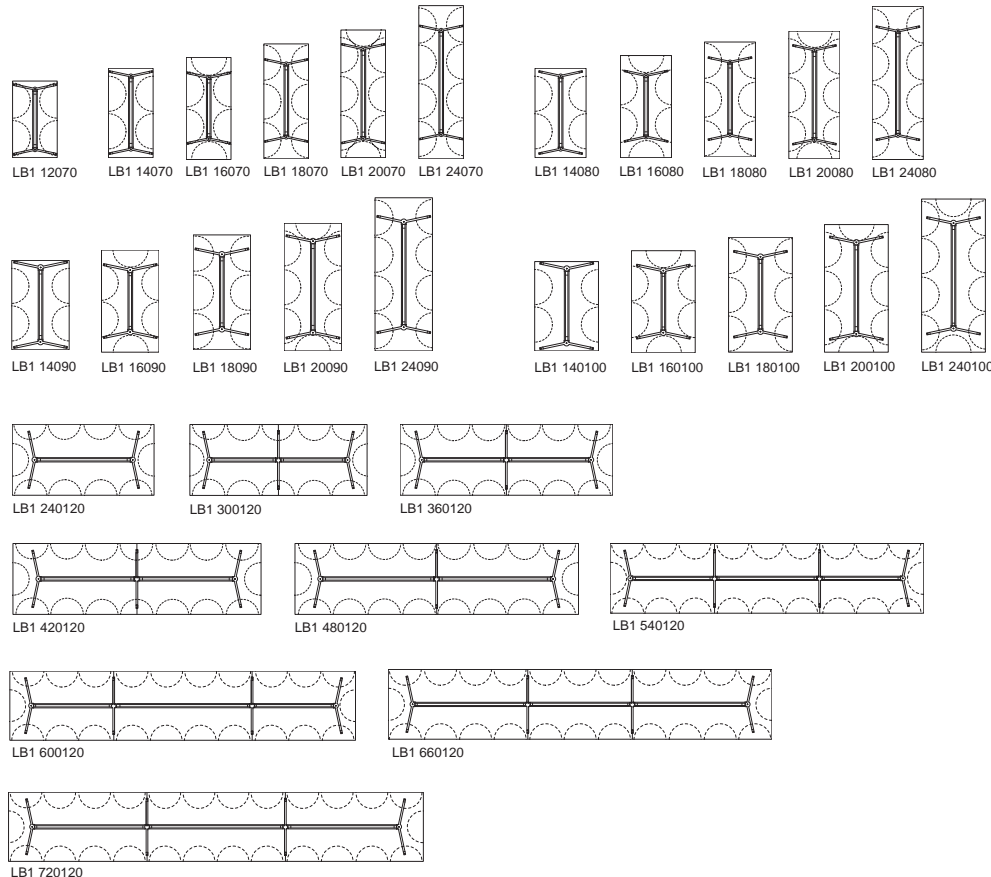
### Artno Bord Table

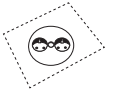
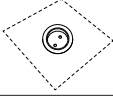
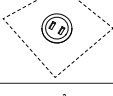
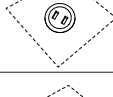

Tillbehör Accessories	Artno	Diam mm		SEK
Bild enl. senare	TKB1LB		Kabelgenomföring med elbrunn. Elbrunn i svart metall monterad på balk under bordet. Lock fast med gångjärn. Exkl. eluttag. Utvändigt mått: L388 B174mm, Invändigt mått L385 B123 D100mm Cable slot with box in black metal assembly to the beam. Fixed lids with hinge. Excl. electrical equipment. Dimension outside L388 W174mm. Internat dimension L385 W123 D100mm	3730
	TKB7LB	ø115	Twist. Lock borstat rostfritt stål. 2 Eluttag. 2m kabel. Gäller för SE, NO, FIN, DE, NL. Twist. Brushed stainless lid. 2 Electrical. 2m cables. For SE, NO, FIN, DE, NL. Only for rectangular	2880
	TKB11LB	ø57	Powerdot Mini. 1 eluttag, svart, 1,5m kabel. Gäller för SE,NO,FIN,DE,NL. Powerdot Mini. 1 electrical black, 1,5m cable. For SE,NO,FIN,DE,NL.	1060
	TKB12LB	ø57	Powerdot Mini. USB A laddare inkl. 2 portar, svart, 1,5m kabel. Gäller för SE,NO,FIN,DE,NL. Powerdot Mini. USB A charging incl. 2 ports, black. 1,5m cable. For SE,NO,FIN,DE,NL.	1430
	TKB19LB	ø57	Powerdot Mini. USB C laddare inkl. 2 portar, svart, 1,25m kabel. Gäller för SE,NO,FIN,DE,NL. Powerdot Mini. USB C charging incl. 2 ports, black, 1,25m cable. For SE,NO,FIN,DE,NL.	1730
	TKB20LB	ø70	Powerdot Midi. 1 eluttag, 1 USB C laddare, svart 1,25m kabel. Gäller för SE,NO,FIN,DE,NL. Powerdot Midi. 1 electrical, 1 USB C charging, black. 1,25m cable. For SE,NO,FIN,DE,NL.	1730

Artno	Längd Length mm	Bredd Width mm	Höjd Height mm	Locus SEK		Extra SEK							
				U Avstånd från golv till underkant  U Distance from floor to bottom edge of table top mm	X Avstånd från kortsida till pelare  X Distance from short side to pedestal mm	Top Faner Veneer .10 ek oak .20 björk birch .30 ask ash	Top Vit White Laminate Pelare Fot Pedestal Foot .61 ek oak .62 björk birch .63 ask ash	Top Svart Black Laminate Pelare Fot Pedestal Foot .65 ek oak .66 björk birch .67 ask ash  Top Laminate Pelare Pedestal .71 ek oak .72 björk birch .73 ask ash	Top Svart Black Desktop Pelare Fot Pedestal Foot .91 ek oak .92 björk birch .93 ask ash	Standardbets på ask Standard stain on ash  Vitpigment ek ask White glazed oak ash	Vikt netto Weight net kilos	Vikt brutto Weight gross kilos	Volym Volume
LB1 12070	1200	700	730	705	94	16720	16880	17510	17140	+2510	24	36	0,2
LB1 14070	1400	700	730	705	94	17830	18020	18780	18590	+2670	26	40	0,25
LB1 16070	1600	700	730	705	294	18240	18440	19250	19050	+2730	28	44	0,26
LB1 18070	1800	700	730	705	294	19290	19510	20410	20180	+2890	30	46	0,28
LB1 20070	2000	700	730	705	264	20590	20830	21800	21560	+3080	34	50	0,30
LB1 24070	2400	700	730	705	344	21870	22140	23250	22970	+3280	40	56	0,34
LB1 14080	1400	800	730	705	94	18880	19090	19940	19730	+2830	28	44	0,26
LB1 16080	1600	800	730	705	294	19360	19580	20470	20250	+2900	30	46	0,28
LB1 18080	1800	800	730	705	294	20540	20800	21810	21560	+3080	34	50	0,3
LB1 20080	2000	800	730	705	264	21200	21470	22530	22260	+3180	38	54	0,32
LB1 24080	2400	800	730	705	344	23420	23730	25010	24690	+3510	46	58	0,35
LB1 14090	1400	900	730	705	74	20630	20850	21740	21520	+3100	30	46	0,28
LB1 16090	1600	900	730	705	274	21800	22060	23080	22820	+3280	34	50	0,3
LB1 18090	1800	900	730	705	274	22330	22600	23660	23390	+3350	38	54	0,32
LB1 20090	2000	900	730	705	244	23830	24130	25310	25020	+3570	44	60	0,35
LB1 24090	2400	900	730	705	324	27350	27730	29260	28870	+4100	48	66	0,4
LB1 140100	1400	1000	730	705	74	21590	21840	22810	22570	+3240	34	50	0,3
LB1 160100	1600	1000	730	705	274	22130	22400	23460	23190	+3320	38	54	0,32
LB1 180100	1800	1000	730	705	274	23500	23800	24980	24690	+3530	44	60	0,35
LB1 200100	2000	1000	730	705	244	25110	25440	26750	26430	+3760	48	66	0,4
LB1 240100	2400	1000	730	705	324	29010	29440	31130	30710	+4360	54	68	0,42
LB1 200120	2000	1200	730	705	244	29270	29690	31390	30960	+4390	60	78	0,45
LB1 240120	2400	1200	730	705	324	34190	34730	36890	36350	+5130	70	86	0,48
LB1 300120	3000	1200	730	705	328	44220	44690	46320	46090	+6640	92	120	0,53
LB1 360120	3600	1200	730	705	328	51630	52240	54360	54050	+7750	110	140	0,64
LB1 420120	4200	1200	730	705	388	59440	60200	62840	62460	+8910	128	163	0,75
LB1 480120	4800	1200	730	705	388	65770	66630	69640	69210	+9870	146	186	0,85
LB1 540120	5400	1200	730	705	328	76170	77070	80230	79780	+11430	165	210	0,96
LB1 600120	6000	1200	730	705	328	81810	82820	86350	85740	+12270	183	233	1,07
LB1 660120	6600	1200	730	705	388	91380	92570	96730	96420	+13710	202	256	1,28
LB1 720120	7200	1200	730	705	388	97390	98690	103210	102570	+14610	220	280	1,35



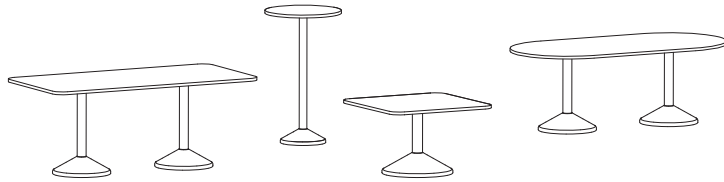

Pivå kommer i rektangulära, kvadratiska, runda och ovala former i en mängd storlekar. Skivan är i fänerad MDF med kantlist. Pelaren är i massivträ med metallkärna och foten är i massivträ med plastassar. Träslagen är ek, ask, standardbetsler på ask och vitpigmenterad ek eller ask. Skivan finns även i laminat (vit, svart, ek, ask) och svart desktop. Som tillval till de rektangulära och ovala skivorna finns olika eluttag att välja mellan. Pivå levereras omonterat. Med hjälp av handverktyg är det enkelt att separera samtliga delar av bordet, efter många års användning.

Pivå comes in rectangular, square, round and oval tabletops in a generous range of sizes. The tops are made of veneered MDF with an edging strip. The pedestals are constructed of solid wood around a metal core and stand on a solid wood base with plastic floor protectors. Choose from oak, ash, standard stains on ash and white glaze on oak or ash. Tabletops are also available in a laminate finish (white, black, oak, ash) and as a black desktop. Several types of electrical outlet are available as optional extras for the rectangular and oval tabletops. Pivå tables are supplied unassembled. Just a few hand tools are all that is needed to disassemble the various components of the tables after many years of continuous use.

Artno

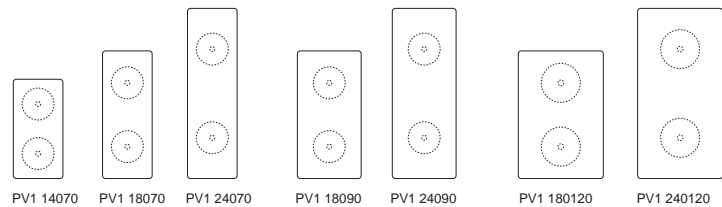

PV1 14070 PV1 18070 PV1 24070 PV1 18090 PV1 24090 PV1 180120 PV1 240120

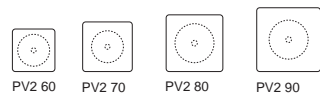

PV2 60 PV2 70 PV2 80 PV2 90

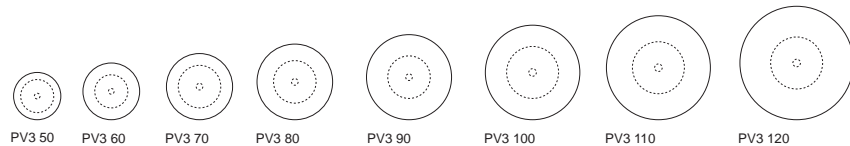

PV3 50 PV3 60 PV3 70 PV3 80 PV3 90 PV3 100 PV3 110 PV3 120

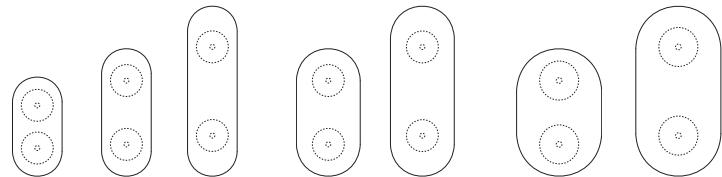

PV5 14070 PV5 18070 PV5 24070 PV5 18090 PV5 24090 PV5 180120 PV5 240120

Tillbehör Accessories	Artno	Diam mm		SEK
	TKB4		<b>Kabelgenomföring med elbrunn, svart. Ett löst lock. Exkl. eluttag. Endast för Rektangulära pelarbord och oval.</b> Cable slot with box, black. For socket and leads. One loose covers. Excl. electrical equipment. Only for Pedestal table rectangular and oval	3100
	TKB7	ø115	<b>Twist. Lock borstat rostfritt stål. 2 Eluttag. 2m kabel. Gäller för SE, NO, FIN, DE, NL. Endast för Rektangulära och ovala pelarbord.</b> Twist. Brushed stainless lid. 2 Electrical. 2m cables. For SE, NO, FIN, DE, NL. Only for Pedestal table rectangular and oval	2590
	TKB11	ø57	<b>Powerdot Mini. 1 eluttag, svart, 1,5m kabel. Gäller för SE,NO,FIN,DE,NL. Endast för Rektangulära och ovala pelarbord.</b> Powerdot Mini. 1electrical black, 1,5m cable. For SE,NO,FIN,DE,NL. Only for Pedestal table rectangular and oval	750
	TKB12	ø57	<b>Powerdot Mini. USB A laddare inkl. 2 portar, svart, 1,5m kabel. Gäller för SE,NO,FIN,DE,NL. Endast för Rektangulära och ovala pelarbord.</b> Powerdot Mini. USB A charging incl. 2 ports, black, 1,5m cable. For SE,NO,FIN,DE,NL. Only for Pedestal table rectangular and oval.	1130
	TKB19	ø57	<b>Powerdot Mini. USB C laddare inkl. 2 portar, svart, 1,25m kabel. Gäller för SE,NO,FIN,DE,NL. Endast för Rektangulära och ovala pelarbord.</b> Powerdot Mini. USB C charging incl. 2 ports, black, 1,25m cable. For SE,NO,FIN,DE,NL. Only for Pedestal table rectangular and oval.	1280
	TKB20	ø70	<b>Powerdot Midi. 1 eluttag, 1 USB C laddare, svart 1,25m kabel. Gäller för SE,NO,FIN,DE,NL. Endast för Rektangulära och ovala pelarbord.</b> Powerdot Midi. 1 electrical, 1 USB C charging, black, 1,25m cable. For SE,NO,FIN,DE,NL. Only for Pedestal table rectangular and oval.	1280

Artno	Längd Length mm	Bredd Width mm	Höjd Height mm	Fot Foot Diam mm	Pivå SEK			Extra SEK		Vikt netto Weight net kilos	Vikt brutto Weight gross kilos	Volym Volume
					Top Faner Veneer .10 ek oak .30 ask ash	Top Vit White Laminate Pelare Fot Pedestal Foot .61 ek oak .63 ask ash	Top Svart Black Laminate Pelare Fot Pedestal Foot .65 ek oak .67 ask ash	Top Svart Black Desktop Pelare Fot Pedestal Foot .91 ek oak .93 ask ash	Standardbets på ask Standard stain on ash  Vitpigment ek ask White glazed oak ash			
<b>Rektangulär Rectangulare</b>												
PV1 14070	1400	700	560	450	22030	22230	23060	22490	+2200	46	50	0,37
PV1 14070	1400	700	650, 730	450	22390	22590	23420	22850	+2240	50/54	56/60	0,42/0,47
PV1 14070	1400	700	900, 1050	450	23260	20910	24300	23740	+2320	60/62	66/68	0,55/0,62
PV1 18070	1800	700	560	450	22450	22660	23550	22970	+2250	58	66	0,4
PV1 18070	1800	700	650, 730	450	22810	23020	23900	23320	+2290	60/62	68/70	0,45/0,5
PV1 18070	1800	700	900, 1050	450	23680	21360	24780	24200	+2370	65/68	72/76	0,58/0,65
PV1 24070	2400	700	650, 730	450	24510	24770	25850	25160	+2450	70/74	78/82	0,5/0,55
PV1 24070	2400	700	900, 1050	450	25400	23100	26740	26040	+2540	80/88	88/96	0,63/0,7
PV1 18090	1800	900	650, 730	450	24220	24490	25580	24860	+2420	76/78	84/86	0,49/0,54
PV1 18090	1800	900	900,1050	450	25100	22820	26450	25740	+2510	86/92	94/100	0,62/0,69
PV1 24090	2400	900	650, 730	450	25910	26210	27490	26660	+2600	84/88	94/100	0,55/0,6
PV1 24090	2400	900	900, 1050	450	26790	24550	28380	27550	+2680	94/100	106/110	0,68/0,75
PV1 180120	1800	1200	650, 730	550	31040	31400	32870	31920	+3120	80/85	90/95	0,7/0,78
PV1 180120	1800	1200	900	550	32110	28420	30100	29160	+3210	90	100	0,88
PV1 240120	2400	1200	650, 730	550	32380	32790	34460	33370	+3230	90/95	105/110	0,75/0,83
PV1 240120	2400	1200	900	550	33460	29810	31690	30600	+3350	105	120	1,05
<b>Kvadratisk Square</b>												
PV2 60	600	600	560	450	11660	11780	12270	11950	+1170	20	24	0,24
PV2 60	600	600	650, 730	450	11840	11960	12440	12130	+1180	22/25	26/30	0,27/0,3
PV2 60	600	600	900, 1050	450	12290	12390	12890	12560	+1230	27/29	32/34	0,37/0,44
PV2 70	700	700	560	450	12620	12770	13430	12990	+1260	24	27	0,32
PV2 70	700	700	650, 730	450	12800	12950	13610	13170	+1280	26/27	29/30	0,37/0,4
PV2 70	700	700	900, 1050	450	13250	13410	14050	13620	+1330	30/31	33/35	0,5/0,58
PV2 80	800	800	560	550	15110	15290	16030	15530	+1520	26	33	0,27
PV2 80	800	800	650, 730	550	15350	15530	16270	15780	+1540	28/32	35/39	0,32/0,34
PV2 80	800	800	900, 1050	550	15890	16070	16810	16310	+1580	36/40	42/46	0,39/0,45
PV2 90	900	900	560	550	15660	15850	16630	16120	+1560	35	39	0,28
PV2 90	900	900	650, 730	550	15900	16090	16880	16380	+1580	37/39	41/43	0,32/0,35
PV2 90	900	900	900	550	16440	16630	17420	16910	+1640	42/44	46/49	0,39/0,45

Artno	Diam mm	Höjd Height mm	Fot Foot Diam mm	Pivå SEK				Extra SEK			
				Top Faner Veneer .10 ek oak .30 ask ash	Top Vit White Laminate Pelare Fot Pedestal Foot .61 ek oak .63 ask ash	Top Svart Black Laminate Pelare Fot Pedestal Foot .65 ek oak .67 ask ash	Top Svart Black Desktop Pelare Fot Pedestal Foot .91 ek oak .93 ask ash	Standardbets på ask Standard stain on ash Vitpigment ek ask White glazed oak ash	Vikt netto Weight net kilos	Vikt brutto Weight gross kilos	Volym Volume
<b>Rund Round</b>											
PV3 50	500	560	350	9700	9770	10120	9900	+960	15	17	0,17
PV3 50	500	650, 730	350	9860	9930	10280	10060	+990	16/17	18/20	0,2/0,22
PV3 50	500	900, 1050	350	10250	10320	10670	10450	+1020	19/20	22/24	0,27/0,32
PV3 60	600	560	350	10270	10370	10810	10520	+1020	17	20	0,24
PV3 60	600	650, 730	350	10430	10530	10970	10670	+1040	19/20	22/24	0,27/0,3
PV3 60	600	900, 1050	350	10810	10920	11360	11070	+1080	22/24	26/28	0,37/0,44
PV3 70	700	560	450	11980	12120	12670	12310	+1200	23	26	0,32
PV3 70	700	650, 730	450	12160	12300	12850	12490	+1210	25/27	28/30	0,37/0,4
PV3 70	700	900, 1050	450	12590	12730	13280	12920	+1260	29/31	33/35	0,5/0,58
PV3 80	800	560	450	12650	12780	13440	13010	+1260	25	32	0,2
PV3 80	800	650, 730	450	12820	12960	13620	13180	+1280	27/28	34/35	0,22/0,24
PV3 80	800	900, 1050	450	13260	13420	14060	13630	+1330	30/32	37/39	0,3/0,34
PV3 90	900	560	450	13320	13500	14250	13750	+1340	26	30	0,21
PV3 90	900	650, 730	450	13500	13680	14430	13930	+1350	27/29	31/33	0,23/0,25
PV3 90	900	900, 1050	450	13940	14120	14860	14370	+1390	31/33	35/37	0,3/0,34
PV3 100	1000	560	550	15880	16080	16910	16360	+1580	36	41	0,29
PV3 100	1000	650, 730	550	16120	16320	17160	16620	+1610	38/40	43/45	0,32/0,35
PV3 100	1000	900	550	16660	16860	17700	17150	+1660	42	48	0,41
PV3 110	1100	560	550	16510	16740	17670	17060	+1650	40	46	0,32
PV3 110	1100	650, 730	550	16770	17000	17920	17300	+1670	42/44	48/50	0,35/0,4
PV3 110	1100	900	550	17300	17530	18470	17840	+1730	46	52	0,44
PV3 120	1200	560	550	17100	17340	18320	17680	+1720	42	48	0,32
PV3 120	1200	650, 730	550	17350	17600	18570	17940	+1740	44/46	50/52	0,40
PV3 120	1200	900	550	17890	18130	19100	18480	+1790	48	55	0,45

Artno	Längd Length mm	Bredd Width mm	Höjd Height mm	Fot Foot Diam mm	Pivå SEK				Extra SEK		Vikt netto Weight net kilos	Vikt brutto Weight gross kilos	Volym Volume
					Top Faner Veneer .10 ek oak .30 ask ash	Top Vit White Laminate Pelare Fot Pedestal Foot .61 ek oak .63 ask ash	Top Svart Black Laminate Pelare Fot Pedestal Foot .65 ek oak .67 ask ash	Top Svart Black Desktop Pelare Fot Pedestal Foot .91 ek oak .93 ask ash	Standardbets på ask Standard stain on ash	Vitpigment ek ask White glazed oak ash			
<b>Oval</b>													
PV5 14070	1400	700	560	450	22030	22230	23060	22490	+2200		46	50	0,37
PV5 14070	1400	700	650, 730	450	22390	22590	23420	22850	+2240		50/54	56/60	0,42/0,47
PV5 14070	1400	700	900, 1050	450	23260	20910	24300	23740	+2320		60/62	66/68	0,55/0,62
PV5 18070	1800	700	560	450	22450	22660	23550	22970	+2250		58	66	0,4
PV5 18070	1800	700	650, 730	450	22810	23020	23900	23320	+2270		60/62	68/70	0,45/0,5
PV5 18070	1800	700	900, 1050	450	23680	21360	24780	24200	+2370		65/68	72/76	0,58/0,65
PV5 24070	2400	700	650, 730	450	24510	24770	25850	25160	+2450		70/74	78/82	0,5/0,55
PV5 24070	2400	700	900, 1050	450	25400	23100	26740	26040	+2540		80/88	98/96	0,63/0,7
PV5 18090	1800	900	650, 730	450	24220	24490	25580	24860	+2420		76/78	84/86	0,49/0,54
PV5 18090	1800	900	900, 1050	450	25100	22820	26450	25740	+2510		86/92	94/100	0,62/0,75
PV5 24090	2400	900	650, 730	450	25910	26210	27490	26660	+2590		84/88	94/100	0,55/0,6
PV5 24090	2400	900	900, 1050	450	26790	24550	28380	27550	+2680		94/100	106/110	0,68/0,75
PV5 180120	1800	1200	650, 730	550	31040	31400	32870	31920	+3110		80/85	90/95	0,7/0,78
PV5 180120	1800	1200	900	550	32110	28420	30100	29160	+3210		90	100	0,88
PV5 240120	2400	1200	650, 730	550	32380	32790	34460	33370	+3230		90/95	105/110	0,75/0,83
PV5 240120	2400	1200	900	550	33460	29810	31690	30600	+3350		105	120	1,05

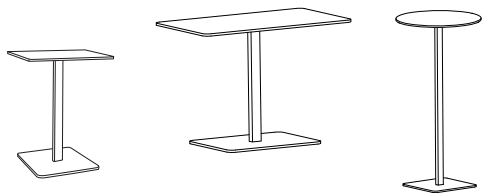

Utgående produkt med reservation för slutförsäljning.

**Pelarbord.**

Skiva och bottenplatta kompaktlaminat, vit eller svart.

Pelare i stål vit eller svartlack.

Bordet kan fästas med dold infästning i golv.

Bordet levereras omonterat. Vid order ange höjd.

Outbound product with reservation for end of stock.

**Pedestal table.**

Tabletop/base in white or black compact laminate.

Pedestal white or black lacquered metal.

The base-plate can be secured to the floor.

The table comes unmounted. When ordering state height.

Artno

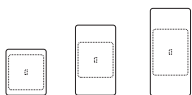

POB10 POB12 POB14

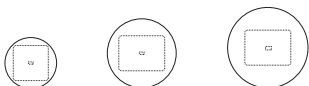

POB40 POB42

**ponoq bord table SEK**

Artno	Längd Length mm	Bredd Width mm	Diameter mm	Höjd Height mm	.60 vit white laminate .61 svart black laminate	Vikt brutto Weight gross kilos	Volym Volume
POB10	400	350		400,460,530	5800	15	0,1
POB12	610	350		400,460,530	6000	20	0,03
POB14	760	350		400,460,530	6910	20	0,05
POB16	500	400		400,460,530	6000	16	0,03
POB40			ø450	400,460,530	6000	15	0,03
POB42			ø600	400,460,530	6910	17	0,04

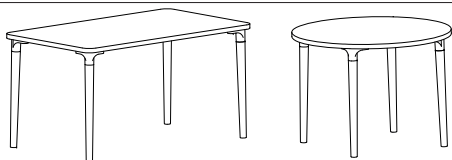

Bord Table

### Bord.

Rektangulär skiva = fanerad trälamell, klarlack.

Rund skiva = fanerad MDF, klarlack.

Träslag ek, björk, ask, standardbetsar på ask eller vitpigmenterad ek och ask. Alternativt är högtryckslaminat (ek, björk, ask, vit eller svart) och svart desktop.

Ben i massiv trä med fäste av sandgjuten 100% återvunnen aluminium med kulpolerad ytbehandling som standard.

Fästet kan även lackas i standardfärger, var vänlig ange vid beställning. Varje fäste är unikt med sin egen struktur och nyans av aluminium.

Benet och fästet går lätt att separera från varandra. Bordet levereras ommonterat. Benen skruvas fast under skivan. Specialmått och andra utförande efter förfrågan. Vid order ange höjd.

### Table.

Rectangulare top = veneered blockboard, clear lacquer.

Round top = veneered MDF, clear lacquer.

Veener in oak, birch, ash, standard stains on ash or white glazed on oak and ash. Table is also available in High Pressure Laminate of oak, birch, white, black laminate and black desktop.

Legs in solid wood incl. socket-style leg mount made of sand-cast 100% recycled aluminium. The mount comes in a ball burnished finish as standard, but can also be lacquered in one of standard colors. Every mount will be unique with its own structure and shade of aluminium.

The table comes unmounted. The legs are screwed under the table top.

Please enquire for details of non-standard sizes and finishes. When ordering state height.

### Artno Bord Table

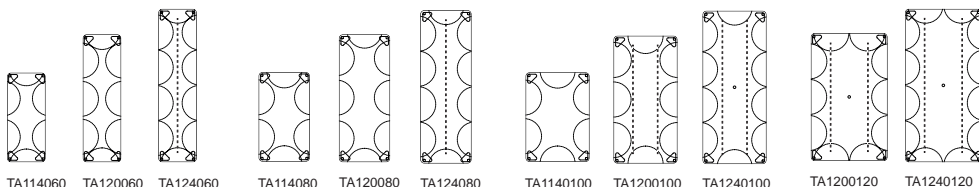

TA114060 TA120060 TA124060 TA114080 TA120080 TA124080 TA1140100 TA1200100 TA1240100 TA1200120 TA1240120

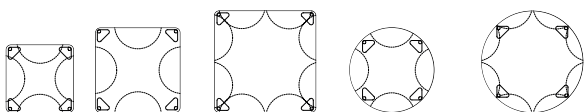

TA280 TA2100 TA2120 TA3100 TA3120

Tillbehör Accessories	Artno	Diam mm		SEK
	TKB4		<b>Kabelgenomföring med elbrunn, svart. Ett löst lock. Exkl. eluttag.</b> Cable slot with box, black. For socket and leads. One loose covers. Excl. electrical equipment.	3100
	TKB7	ø115	<b>Twist. Lock borstat rostfritt stål. 2 Eluttag. 2m kabel.</b> <b>Gäller för SE, NO, FIN, DE, NL.</b> Twist. Brushed stainless lid. 2 Electrical. 2m cables. For SE, NO, FIN, DE, NL.	2590
	TKB11	ø57	<b>Powerdot Mini. 1 eluttag, svart, 1,5m kabel. Gäller för SE,NO,FIN,DE,NL.</b> Powerdot Mini. 1electrical black, 1,5m cable. For SE,NO,FIN,DE,NL.	750
	TKB12	ø57	<b>Powerdot Mini. USB A laddare inkl. 2 portar, svart, 1,5m kabel.</b> <b>Gäller för SE,NO,FIN,DE,NL.</b> Powerdot Mini. USB A charging incl. 2 ports, black, 1,5m cable. For SE,NO,FIN,DE,NL.	1130
	TKB19	ø57	<b>Powerdot Mini. USB C laddare inkl. 2 portar, svart, 1,25m kabel.</b> <b>Gäller för SE,NO,FIN,DE,NL.</b> Powerdot Mini. USB C charging incl. 2 ports, black, 1,25m cable. For SE,NO,FIN,DE,NL.	1280
	TKB20	ø70	<b>Powerdot Midi. 1 eluttag, 1 USB C laddare, svart 1,25m kabel.</b> <b>Gäller för SE,NO,FIN,DE,NL.</b> Powerdot Midi. 1 electrical, 1 USB C charging, black. 1,25m cable. <small>For SE,NO,FIN,DE,NL.</small>	1280



Artno	Längd Length mm	Bredd Width mm	Diam. mm	Höjd Height mm	Tailor bord table SEK				Extra SEK		Vikt brutto Weight gross kilos	Volym Volume
					Top Faner Veneer Ben Legs .10 ek oak .20 björk birch .30 ask ash	Top Vit Laminat White Laminat Ben Legs .61 ek oak .62 björk birch .63 ask ash	Top Svart Black Laminat Ben Legs .65 ek oak .66 björk birch .67 ask ash	Top Svart Black Desktop Ben Legs .91 ek oak .92 björk birch .93 ask ash	Standardbets på ask Standard stain on ash  Vitpigment ek ask White glazed oak ash	+Benfäste i svart eller vit Socket style-leg in black or white		
<b>Rektangulär Rectangulare</b>												
TA114060	1400	600		730,900	15720	15920	16740	16450	+2360	+780	25	0,12
TA120060	2000	600		730,900	17570	17820	18980	18740	+2640	+780	31	0,17
TA124060	2400	600		730,900	20620	20860	22500	21910	+3110	+780	35	0,2
TA114080	1400	800		730,900	16940	17150	18020	17660	+2540	+780	30	0,16
TA120080	2000	800		730,900	19600	19960	21130	20780	+2940	+780	38	0,21
TA124080	2400	800		730,900	23010	23300	24940	24350	+3450	+780	43	0,25
TA1140100	1400	1000		730,900	19080	19300	20610	19890	+2850	+780	34	0,19
TA1200100	2000	1000		730,900	24770	25070	26510	25830	+3710	+780	44	0,25
TA1240100	2400	1000		730,900	31330	31680	33400	32670	+4700	+990	51	0,3
TA1200120	2000	1200		730,900	31330	31680	33150	32470	+4700	+990	52	0,29
TA1240120	2400	1200		730,900	37980	38430	40120	39410	+5700	+990	59	0,35
<b>Kvadratisk Square</b>												
TA280	800	800		730,900	14410	14490	15220	14770	+2170	+780	22	0,1
TA2100	1000	1000		730,900	19180	19300	20120	19600	+2860	+780	28	0,14
TA2120	1200	1200		730,900	21480	21630	22510	21920	+3220	+780	35	0,19
<b>Rund Round</b>												
TA3100			ø1000	730,900	14740	14870	15690	15150	+2220	+780	28	0,14
TA3120			ø1200	730,900	16040	16210	17080	16490	+2410	+780	35	0,19



### Bord.

Bordsskiva av trälamell med faner i ek, bjök, körsbär, standardbetser på ek och vitpigment på ek. Alternativt är högtryckslaminat i ek, björk, ask, vit och svart laminat. Ytbehandling är klarlack alternativt olja+lack. Ben i massivt stål med blästrad yta i mattkrom eller slipad yta i blankkrom.

Andra mått och utförande efter förfrågan. Bordet levereras omonterat. Benen skruvas fast under bordsskivan. Vid beställning ange höjd och utförande på ben.

### Table.

Table top in blockboard of veneer in oak, birch, cherry, standard stains on oak or white glazed on oak. Table is also available in High Pressure Laminate in oak, birch, ash, white and black laminate. Finish clear lacquer or oil+lacquer. Legs of solid steel with a shot-blasted matt chrome finish, or a polished chrome surface.

Special sizes and other finishes upon request. The table comes unmounted. The legs are screwed under the table top. When ordering state height and execution of legs.

Artno

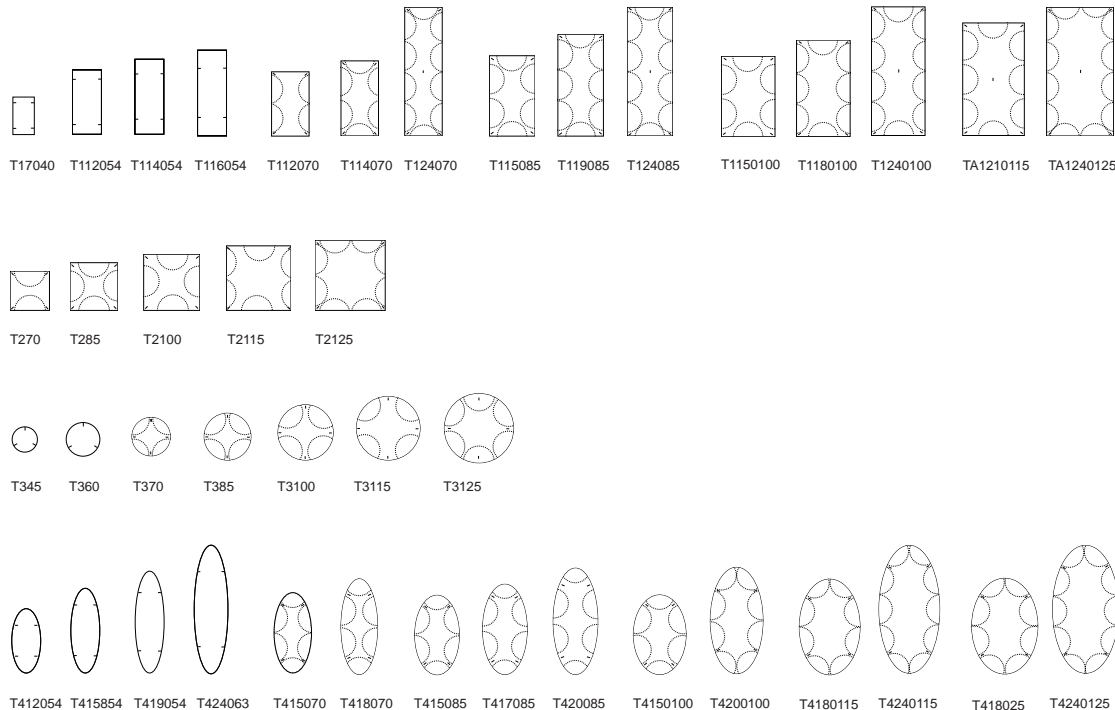

Tillbehör Accessories	Artno	Diam mm		SEK
	TKB4		<b>Kabelgenomföring med elbrunn, svart. Ett löst lock. Exkl. eluttag.</b> Cable slot with box, black. For socket and leads. One loose covers. Excl. electrical equipment.	3100
	TKB7	ø115	<b>Twist. Lock borststål rostfritt stål. 2 Eluttag. 2m kabel. Gäller för SE, NO, FIN, DE, NL.</b> Twist. Brushed stainless steel. 2 Electrical. 2m cables. For SE, NO, FIN, DE, NL.	2590
	TKB11	ø57	<b>Powerdot Mini. 1 eluttag, svart, 1,5m kabel. Gäller för SE, NO, FIN, DE, NL.</b> Powerdot Mini. 1 electrical black, 1,5m cable. For SE, NO, FIN, DE, NL.	750
	TKB12	ø57	<b>Powerdot Mini. USB A laddare inkl. 2 portar, svart, 1,5m kabel. Gäller för SE, NO, FIN, DE, NL.</b> Powerdot Mini. USB A charging incl. 2 ports, black, 1,5m cable. For SE, NO, FIN, DE, NL.	1130
	TKB19	ø57	<b>Powerdot Mini. USB C laddare inkl. 2 portar, svart, 1,25m kabel. Gäller för SE, NO, FIN, DE, NL.</b> Powerdot Mini. USB C charging incl. 2 ports, black, 1,25m cable. For SE, NO, FIN, DE, NL.	1280
	TKB20	ø70	<b>Powerdot Midi. 1 eluttag, 1 USB C laddare, svart 1,25m kabel. Gäller för SE, NO, FIN, DE, NL.</b> Powerdot Midi. 1 electrical, 1 USB C charging, black, 1,25m cable. For SE, NO, FIN, DE, NL.	1280

Rektangulär Rectangulare				Trippo bord table SEK				Extra SEK		
Artno	Längd Length mm	Bredd Width mm	Höjd Height mm	Top Faner Veneer .10 ek oak .20 björk birch	Top Faner Veneer .43 körsbär cherry	Top .60 Vit White laminat	Top .61 Svart Laminat Black Laminat  Top Laminat .71 ek oak .72 björk birch .73 ask ash	Skiva olja+lack Standardbets, Vit pigment på ek Top oil+lacquer Standard stain, White glazed on oak	Vikt brutto Weight gross kilos	Volym Volume
T17040	700	400	400,460,530	9330	9510	9480	10060	+460	13	0,05
T17040	700	400	620,720	14640	14820	14710	15350	+460	22	0,06
T112054	1200	540	400,460,530	11370	11690	11560	12250	+770	18	0,07
T112054	1200	540	620,720	16710	17030	16900	17590	+770	27	0,08
T114054	1400	540	400,460,530	11770	12090	11960	12740	+820	18	0,08
T114054	1400	540	620,720	17080	17430	17270	18060	+820	27	0,09
T116054	1600	540	400,460,530	12560	12940	12750	13570	+950	19	0,08
T116054	1600	540	620,720	17890	18260	18080	18890	+950	28	0,09
T112070	1200	700	400,460,530	12340	12720	12540	13280	+930	22	0,1
T112070	1200	700	620,720	17650	18030	17840	18580	+930	31 38	0,11 0,14
T114070	1400	700	400,460,530	13370	13810	13570	14440	+1060	24	0,12
T114070	1400	700	620,720	18690	19100	18880	19740	+1060	33 40	0,13 0,16
T124070	2400	700	620,720	24490	25120	24750	26340	+1490	44 51	0,15 0,18
T115085	1500	850	400,460,530	14660	15170	14890	15730	+1260	27	0,12
T115085	1500	850	620,720	19970	20470	20200	21050	+1260	36 43	0,13 0,16
T119085	1900	850	620,720	21230	21840	21610	22860	+1440	40 47	0,15 0,23
T124085	2400	850	620,720	27850	28670	28130	29730	+2040	52 59	0,18 0,21
T1150100	1500	1000	620,720	21420	22020	21650	22950	+1460	39 46	0,18 0,21
T1180100	1800	1000	620,720	22310	22970	22680	23950	+1620	43 50	0,21 0,24
T1240100	2400	1000	620,720	30210	31150	30560	32310	+2360	57 64	0,28 0,31
T1210115	2100	1150	620,720	30340	31310	30660	32210	+2390	57 64	0,27 0,3
T1240125	2400	1250	620,720	36190	37510	36650	38350	+3250	67 74	0,33 0,36

Kvadratisk Square				Trippo bord table SEK				Extra SEK		
Artno	Längd Length mm	Bredd Width mm	Höjd Height mm	Top Faner Veneer .10 ek oak .20 björk birch	Top Faner Veneer .43 körsbär cherry	Top .60 Vit White Laminate	Top .61 Svart laminat Black Laminate  Top Laminate .71 ek oak .72 björk birch .73 ask ash	Skiva olja+lack Standardbets, Vit pigment på ek Top oil+lacquer Standard stain, White glazed on oak	Vikt brutto Weight gross kilos	Volym Volume
T270	700	700	400,460.530	10790	11080	10880	11530	+690	15	0,07
T270	700	700	620,720	16100	16380	16190	16820	+690	24	0,08
T285	850	850	400,460.530	12030	12380	12130	12860	+860	18	0,08
T285	850	850	620,720	17340	17670	17440	18170	+860	27	0,09
T2100	1000	1000	400,460.530	13490	13930	13630	14440	+1080	20	0,17
T2100	1000	1000	620,720	18840	19260	18960	19780	+1080	29 36	0,18 0,21
T2115	1150	1150	400,460.530	14980	15530	15160	16060	+1330	27	0,18
T2115	1150	1150	620,720	20300	20820	20470	21360	+1330	36 43	0,19 0,22
T2125	1250	1250	400,460.530	15650	16210	15820	16820	+1410	30	0,18
T2125	1250	1250	620,720	21230	21510	21130	22430	+1410	39 46	0,19 0,22

Rund Round			Trippo bord table SEK				Extra SEK			
Artno	Diameter mm	Höjd Height mm	Top Faner Veneer .10 ek oak .20 björk birch	Top Faner Veneer .43 körsbär cherry	Top .60 Vit White Laminate	Top .61 Svart Laminat Black Laminate  Top Laminate .71 ek oak .72 björk birch .73 ask ash	Skiva olja+lack Standardbets, Vit pigment på ek Top oil+lacquer Standard stain, White glazed on oak	Vikt brutto Weight gross kilos	Volym Volume	
T345	ø450	400,460.530	6970	7120	7060	7520	+360	9	0,04	
T345	ø450	620,720	10960	11110	11030	11500	+360	20	0,05	
T360	ø600	400,460.530	8020	8230	8110	8560	+490	12	0,05	
T360	ø600	620,720	12020	12210	12080	12550	+490	23	0,06	
T370	ø700	400,460.530	10790	11080	10870	11340	+690	16	0,06	
T370	ø700	620,720	16100	16380	16190	16820	+690	25	0,07	
T385	ø850	400,460.530	12030	12380	12130	12860	+860	20	0,07	
T385	ø850	620,720	17340	17670	17440	18170	+860	29	0,08	
T3100	ø1000	400,460.530	13490	13930	13630	14440	+1080	21	0,09	
T3100	ø1000	620,720	18840	19260	18960	19780	+1080	30	0,1	
T3115	ø1150	400,460.530	14980	15530	15150	15950	+1330	28	0,12	
T3115	ø1150	620,720	20300	20820	20450	21270	+1330	37 44	0,13 0,16	
T3125	ø1250	400,460.530	15650	16210	15820	16820	+1410	27	0,13	
T3125	ø1250	620,720	20960	21510	21100	22000	+1410	36 41	0,14 0,17	

Oval				Trippo bord table SEK				Extra SEK		
Artno	Längd Length mm	Bredd Width mm	Höjd Height mm	Top Faner Veneer .10 ek oak .20 björk birch	Top Faner Veneer .43 körsbär cherry	Top .60 Vit White laminate	Top .61 Svart Laminat Black Laminat  Top Laminat .71 ek oak .72 björk birch .73 ask ash	Skiva olja+lack Standardbets, Vit pigment på ek Top oil+lacquer Standard stain, White glazed on oak	Vikt brutto Weight gross kilos	Volym Volume
T412054	1200	540	400,460.530	11380	11710	11580	12270	+770	18	0,07
T412054	1200	540	620,720	16720	17040	16910	17600	+770	27	0,08
T415854	1580	540	400,460.530	12500	12880	12700	13500	+950	21	0,08
T415854	1580	540	620,720	17820	18190	18020	18840	+950	30	0,09
T419054	1900	540	400,460.530	13030	13440	13250	14150	+1020	24	0,06
T419054	1900	540	620,720	18330	18730	18550	19460	+1020	33	0,07
T424063	2400	630	400,460.530	15330	15880	15590	17160	+1380	31	0,1
T424063	2400	630	620,720	20650	21190	20900	22480	+1380	40	0,11
T415070	1500	700	400,460.530	13130	13570	13370	14240	+1040	25	0,1
T415070	1500	700	620,720	18480	18890	18710	19540	+1040	34 41	0,11 0,14
T418070	1800	700	400,460.530	14520	15030	14720	15670	+1260	28	0,12
T418070	1800	700	620,720	19830	20340	20040	20980	+1260	37 44	0,13 0,16
T415085	1500	850	400,460.530	14660	15170	14850	15710	+1270	28	0,12
T415085	1500	850	620,720	19970	20470	20180	21030	+1270	37 44	0,13 0,16
T417085	1700	850	620,720	21090	21670	21300	22110	+1430	40 47	0,13 0,16
T420085	2000	850	620,720	21720	22340	22100	23350	+1530	42 49	0,16 0,19
T4150100	1500	1000	400,460.530	16100	16710	16320	17630	+1470	31	0,13
T4150100	1500	1000	620,720	21420	22020	21650	22950	+1470	40 47	0,14 0,17
T4200100	2000	1000	620,720	23480	24220	23790	25160	+1800	48 55	0,33 0,36
T4180115	1800	1150	620,720	25160	25980	25520	26980	+2060	48 55	0,24 0,27
T4240115	2400	1150	620,720	31590	32790	32030	33740	+3010	61 68	0,3 0,33
T4180125	1800	1250	620,720	26350	27250	26720	27950	+2220	56 63	0,26 0,29
T4240125	2400	1250	620,720	33320	34630	33760	35470	+3250	66 73	0,43 0,46

## Bord och Skål.

Bordet finns i två höjder och tre storlekar på skivan. Foten är av gjuten betong eller lackad i standardfärger. Stativet finns i blank krom eller lackad i standardfärger, med eller utan ring. Bordsskivan i massiv ek, björk, ask, standardfärger, standardbetsar på ask och vitpigmenterad ek eller ask. Som tillbehör finns lackad fot i standardfärger och tre krokare i blankkrom som hängs under bordsskivan.

Skålen inkl. planteringskärl finns i fyra höjder och en storlek. Foten är av gjuten betong. Pelare i blankkrom eller standardfärger. Planteringskärl är svart ABS plast. Som tillbehör finns lackad fot i standardfärger.

Den gjutna betongfoten får bäst stabilitet på hårda golv som parkett, klinkers, betong, plastmatta eller liknande. Undvik att placera bordet på tjocka och mjuka mattor med lugg där Lollipop kan bli något instabilt.

Bordet och skål levereras monterat. Vid beställning ange artikelnummer, utförande och höjd.

## Table and Bowl.

The table comes in two heights with tops in three different sizes. Choose a frame with or without a ring in shiny chrome or standard colors finishes. The table top is in solid oak, birch, ash or finished in our standard colors, standard stains on ash or white glazed oak or ash. Maximum three hooks in polished chrome are available as optional extras to hang things on below the table surface.

The planter, complete with a bowl for plants, comes in four heights and one size. The cast concrete foot is also available lacquered in our standard colours. The pillar comes in polished chrome or standard colors. The planting bowl is in black plastic ABS.

The concrete foot stands best on surfaces such as parquet flooring, quarry tiles, concrete, plastic matting or similar. Avoid placing the table on thick rugs or those with a soft pile as there is a risk that the table may be less stable on this kind of surface.

Tables and planters are delivered assembled. When ordering, please state article number, height and choice of finish.

### Artno Bord Table



LO329 50R = H 500/750  
LO329 55R = H 550/800

ø290

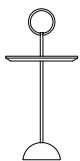

LO338 50R = H 500/750  
LO338 55R = H 550/800

ø380

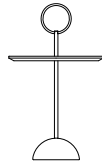

LO350 50R = H 500/750  
LO350 55R = H 550/800

ø500



LO329 50U = H 500  
LO329 55U = H 550

ø290

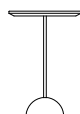

LO338 50U = H 500  
LO338 55U = H 550

ø380



LO350 50U = H 500  
LO350 55U = H 550

ø500

### Artno Skål Bowl



LOS60 = H 600  
LOS65 = H 650



LOS100 = H 1000  
LOS115 = H 1150



				Lollipop SEK	Extra SEK		
Artno Pelare blankkrom Pedestal polish chrome	Artno Pelare lack Pedestal color	Diameter mm	Höjd skiva/Höjd med ring Height top/height inkl. ring mm	.10 ek oak .20 björk birch .30 ask ash .50 lack color	Standardbets på ask Standard stain on ash Vitpigment ek ask White glazed oak ash	Vikt brutto Weight gross kilos	Volym Volume
<b>Inclusive Ring</b>							
LO329 50RK*	LO329 50RL*	ø290	500/750	4900	+340	9	0,10
LO329 55RK*	LO329 55RL*	ø290	550/800	4900	+340	9	0,10
LO338 50RK*	LO338 50RL*	ø380	500/750	5350	+400	10	0,15
LO338 55RK*	LO338 55RL*	ø380	550/800	5350	+400	10	0,15
LO350 50RK	LO350 50RL	ø500	500/750	6820	+540	17	0,16
LO350 55RK	LO350 55RL	ø500	550/800	6820	+540	17	0,16
<b>Exclusive Ring</b>							
			<b>Höjd skiva Height top</b>				
LO329 50UK*	LO329 50UL*	ø290	500	4200	+340	8	0,07
LO329 55UK*	LO329 55UL*	ø290	550	4200	+340	8	0,07
LO338 50UK*	LO338 50UL*	ø380	500	4650	+400	9	0,10
LO338 55UK*	LO338 55UL*	ø380	550	4650	+400	9	0,10
LO350 50UK	LO350 50UL	ø500	500	5930	+540	16	0,16
LO350 55UK	LO350 55UL	ø500	550	5930	+540	16	0,16
Artno Skål inkl. planteringskärl Pelare blankkrom Bowl incl. planter Pedestal polish chromed	Artno Skål inkl. planteringskärl. Pelare lack. Bowl incl. planter Pedestal color	Diameter mm	Höjd Height	<b>Skål Bowl SEK</b>			
LOS60K	LOS60L	ø250	600	4820		15	0,10
LOS65K	LOS65L	ø250	650	4820		15	0,10
LOS100K	LOS100L	ø250	1000	4950		17	0,12
LOS115K	LOS115L	ø250	1150	4950		17	0,12
				<b>Tillbehör Accessories SEK</b>			
*LOF 20 lackad fot painted base foot		ø200		+960			
LOF 25 lackad fot painted base		ø250		+1070			

# CAP PODIUM Roger Persson 2021

Pelare och skiva i massiv trä. Skivan har en nedfasad kant. Träslagen är ek, björk, ask, standardfärger, standardbetsar på ask och vitpigmenterad ek och ask. Vid standardfärg är skivan i MDF. Specialmått och andra utförande efter förfrågan. Podium levereras monterad med skiva. Vid beställning ange artikelnummer och höjd.

Pedestal and table top in solid wood. The table top is milled down. Choose between oak, birch, ash, standard colors, standard stain on ash and white glazed on oak and ash. When using the standard colors the table top made in MDF. Special dimensions and other designs on request. The Cap podium comes mounted. When ordering state article number and height.

Artno

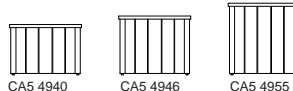

Artno	Diam mm	Höjd Height mm	Cap Podium SEK	Extra SEK			Vikt netto Weight net kilos	Vikt brutto Weight gross kilos	Volym Volume
			Top Massiv solid wood Pelare Pedestal .10 ek oak .20 björk birch .30 ask ash .50 lack color	Standardbets på ask skiva Standard stain on ash top Vitpigment ek ask White glazed oak ash	Standardbets på ask pelare Standard stain on ash pedestal Vitpigment ek ask White glazed oak ash				
CA5 2940	290	395	8290	+400	+810	8	12	0,04	
CA5 2946	290	455	8290	+400	+810	8	12	0,05	
CA5 2955	290	545	8290	+400	+810	9	13	0,08	
CA5 3540	350	380	11030	+540	+1010	8	12	0,07	
CA5 3546	350	440	11030	+540	+1010	10	14	0,08	
CA5 3555	350	530	11030	+540	+1010	10	14	0,09	
CA5 4940	490	355	14360	+570	+1210	21	25	0,17	
CA5 4946	490	415	14360	+570	+1210	22	26	0,18	
CA5 4955	490	505	14360	+570	+1210	22	26	0,19	
Tillbehör Accessories									
TKB11C	57		2040 svart black						
TKB12C	57		2420 svart black						

Tillbehör Accessories



TKB11C

**Powerdot Mini. Placeras i pelare. 1 eluttag, svart, 1,5m kabel. Gäller för SE,NO, FIN,DE,NL.**

Powerdot Mini. Placed in the pedestal. 1 electrical black, 1,5m cable. For SE,NO, FIN,DE,NL



TKB12C

**Powerdot Mini. Placeras i pelare. USB A laddare inkl. 2 portar, svart, 1,5m kabel. Gäller för SE,NO, FIN,DE,NL.**

Powerdot Mini. Placed in the pedestal. USB A charging incl. 2 ports, black, 1,5m cable. For SE,NO,FIN,DE,NL

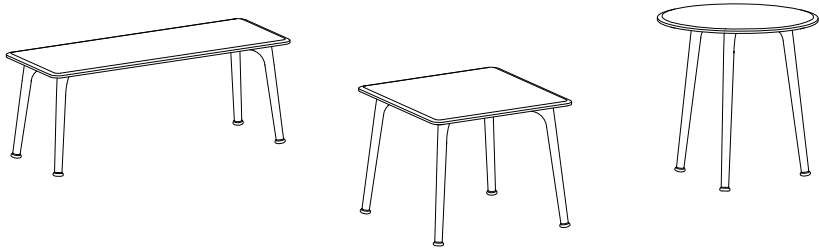

### Bord.

Skiva och ben i massiv trä i ek, björk, ask, standardfärger, standardbetser på ask och vitpigment på ek eller ask. Bordsskiva i standardfärg/lack tillverkas i MDF. Ytbehandling klarlack. Filtass är monterad under ben. Specialmått och andra utförande efter förfrågan. Bordet levereras omonterat. Benen skruvas fast under bordsskivan. Vid order ange höjd.

### Table.

Top and leg in solid wood in oak, birch, ash, standard colors, standard stains on ash or white glazed on oak or ash. Table top in standard colors are made in MDF. Finish clear lacquer. Felt floor protection under the legs. Special sizes or finishes upon request. The table comes unmounted. The legs are screwed under the table top. When ordering state height.

### Artno

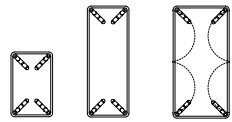

BA17045 BA112045 BA112060

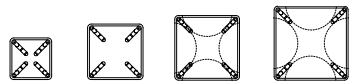

BA245 BA260 BA270 BA280



H470/570



BA350 BA360 BA370 H720 BA380 BA390 BA3100

### Bat SEK

### Extra SEK

Artno	Längd Length mm	Bredd Width mm	Diameter mm	Höjd Height mm	.10 ek oak .20 björk birch .30 ask ash	.50 lack color	Standardbets på ask Standard stain on ash Vitpigment ek ask White glazed oak ash	Vikt brutto Weight gross kilos	Volym Volume
<b>Rektangulär Rectangulare</b>									
BA17045	700	450		470,570	9200	8290	+1390	7	0,04
BA112045	1200	450		470,570	10520	8810	+1610	15	0,06
BA112060	1200	600		470,570	11480	9290	+1860	18	0,08
BA112060	1200	600		720	12410	10220	+1860	20	0,1
<b>Kvadratisk Square</b>									
BA245	450	450		470,570	8340	7720	+1270	8	0,04
BA260	600	600		470,570	9480	8350	+1430	10	0,05
BA270	700	700		470,570	10200	8660	+1540	12	0,07
BA270	700	700		720	11160	9580	+1540	14	0,09
BA280	800	800		470,570	11090	9150	+1810	16	0,08
BA280	800	800		720	12020	10090	+1810	18	0,1
<b>Rund Round</b>									
BA350			ø500	470,570	7340	6560	+1100	7	0,04
BA360			ø600	470,570	8120	6910	+1250	9	0,05
BA370 4ben/legs			ø700	470,570	10310	8660	+1440	11	0,07
BA370 3ben/legs			ø700	720	9560	7930	+1440	13	0,09
BA380			ø800	470,570	11120	9150	+1820	14	0,08
BA380			ø800	720	12050	10090	+1820	16	0,1
BA390			ø900	470,570	11840	9550	+1940	15	0,09
BA390			ø900	720	12770	10490	+1940	17	0,1
BA3100			ø1000	470,570	13070	10130	+2120	18	0,1
BA3100			ø1000	720	13980	11090	+2120	20	0,12

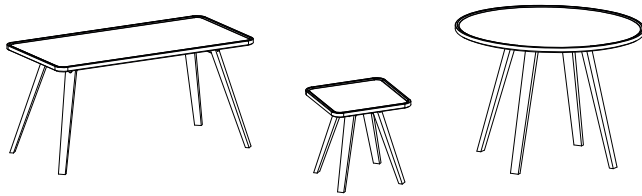

**Bord.**

Skiva och ben i massiv trä ek, björk, ask, standardfärger, standardbetsar på ask och vit pigment på ek eller ask. Bordsskiva i standardfärg/lack tillverkas i MDF. Ytbehandling klar-lack. Specialmått och andra utförande efter förfrågan. Bordet levereras omonterat. Benen skruvas fast under bordsskivan. Vid order ange höjd.

**Table.**

Top and leg in solid wood of oak, birch, ash, standard colors, standard stains on ash and white glazed on oak or ash. Table top in standard colors are made in MDF. Specials sizes and other finishes upon request. The table comes unmounted. The legs are screwed under the table top. When ordering state height.

Artno

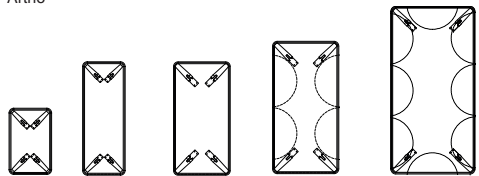

MI17045 MI112045 MI112060 MI114070 MI118090

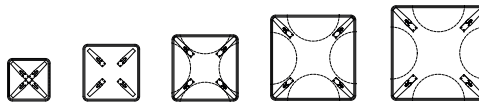

MI245 MI260 MI270 MI290 MI2100

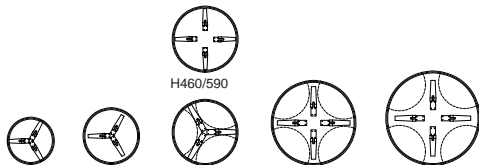

MI350 MI360 MI370 H720 MI390 MI3100

**MILL SEK**

**Extra SEK**

Artno	Längd Length mm	Bredd Width mm	Diameter mm	Höjd Height mm	.10 ek oak .20 björk birch .30 ask ash	.50 lack color	Standardbets på ask Standard stain on ash Vitpigment ek ask White glazed oak ash	Vikt brutto Weight gross kilos	Volym Volume
<b>Rektangulär Rectangulare</b>									
MI17045	700	450		460,590	9640	8960	+1450	10	0,04
MI112045	1200	450		460,590	12300	10890	+1790	16	0,06
MI112060	1200	600		460,590	14100	12050	+2130	24	0,08
MI112060	1200	600		720	14950	12990	+2130	26	0,1
MI114070	1400	700		460,590	17210	14430	+2720	28	0,1
MI114070	1400	700		720	18120	15410	+2720	30	0,12
MI118090	1800	900		720	24900	17530	+3750	43	0,13
<b>Kvadratisk Square</b>									
MI245	450	450		460,590	8160	7870	+1180	8	0,04
MI260	600	600		460,590	10290	9520	+1460	12	0,05
MI270	700	700		460,590	11660	10460	+1920	15	0,06
MI270	700	700		720	12520	11440	+1920	17	0,08
MI290	900	900		460,590	15430	12920	+2440	24	0,08
MI290	900	900		720	16270	13910	+2440	26	0,1
MI2100	1000	1000		460,590	17160	14650	+2720	30	0,1
MI2100	1000	1000		720	18040	15620	+2720	32	0,12
<b>Rund Round</b>									
MI350			ø500	460	7600	6930	+1140	8	0,04
MI360			ø600	460,590	9050	8160	+1350	8	0,04
MI370 4ben/legs			ø700	460,590	11660	10460	+1660	15	0,06
MI370 3ben/legs			ø700	720	11090	9850	+1660	17	0,08
MI390			ø900	460,590	15430	12920	+2440	21	0,08
MI390			ø900	720	16270	13910	+2440	23	0,1
MI3100			ø1000	460,590	17160	14650	+2720	27	0,1
MI3100			ø1000	720	18040	15620	+2720	30	0,12

## MOPSY Markus Johansson 2016



MP1  
Totale L706 W462



MP2  
Totale L968 W598

**Soffbord.** Massiv trä, klarlack.  
Ange utförande på stativ och respektive skiva.  
Bord levereras monterat.

**Sofa table.** Solid wood, clear lacquer.  
State when ordering finish of legs and each tops.  
Table comes pre-assembled.

Artno	Längd Length mm	Bredd Width mm	Diam mm	Höjd Height mm	Mopsy SEK		Vikt brutto Weight gross kilos	Volym Volume	
					.10 ek oak .20 björk birch .30 ask ash .50 lack color	Standardbets på ask per skiva Standard stain on ash each top Vitpigment ek ask per skiva White pigment oak ash each top			
MP1	370	370	462	472/422	8490	+400	+420	14	0,20
MP2	518	518	598	500/450	10130	+420	+510	15	0,35

## EIGHT Louise Hederström 2018



EI24



EI46



EI62

**Soffbord.** Massiv trä, klarlack.  
Filttass. Vid lack är skivan MDF.  
Bord levereras monterat.

**Sofa table.** Solid wood, clear lacquer.  
Felt floor protection. When lacquering top in MDF.  
Table comes pre-assembled.

Artno	Längd Length mm	Bredd Width mm	Höjd Height mm	Eight SEK		Vikt brutto Weight gross kilos	Volym Volume	
				.10 ek oak .20 björk birch .30 ask ash	.50 lack color			
EI24	352	352	530	5190	4580	+770	4	0,12
EI46	454	454	575	5770	4730	+860	4,5	0,17
EI62	600	600	480	6580	4890	+1000	7	0,19

## PUDDLE Anton Björnsing 2017



PU510



PU520



PU530

**Soffbord.** Massiv trä, klarlack.  
Filttass. Vid lack är skivan MDF.  
Bordet levereras omonterat.  
Vid order ange höjd på bordet.

**Sofa table.** Solid wood, clear lacquer.  
Felt floor protection. When lacquering top in MDF.  
Table comes unmounted.  
State when ordering height of table.

Artno	Längd Length mm	Bredd Width mm	Höjd Height mm	Puddle SEK		Vikt brutto Weight gross kilos	Volym Volume	
				.10 ek oak .20 björk birch .30 ask ash	.50 lack color			
PU510	450	410	380,450,520,590	8230	7700	+1210	10	0,04
PU520	550	500	380,450,520,590	9370	8220	+1410	12	0,04
PU530	720	660	380,450,520,590	10630	8800	+1600	14	0,06

SENAB

22% RABATT SKA DRAS AV PÅ ANGIVNA PRISER

# TERRANE

Nestor Campus 2020

**Soffbord.** Massiv trä, klarlack.  
Bordet är försett med tassar.  
Bordet levereras monterat.  
Vid order ange höjd på bordet.

**Sofa table.** Solid wood, clear lacquer.  
Legs included felt protection.  
Table comes mounted.  
State when ordering height of table.



Slät Flat top  
TN345xx1 = ø450



Två nivåer Two levels  
TN345xx2 = ø450



Tre nivåer Three levels  
TN345xx3 = ø450

Artno	Diameter mm	Höjd Height mm	Terrane SEK	Extra SEK	Vikt brutto Weight gross kilos	Volym Volume
			.10 ek oak .20 björk birch .30 ask ash	Standardbets på ask Standard stain on ash Vitpigment ek ask White glazed oak ash		
<b>SLÄT TOP FLAT TOP</b>						
TN3 45331	ø450	330	5510	+820	5	0,09
TN3 45451	ø450	450	5510	+820	6	0,13
<b>TVÅ NIVÅER TWO LEVELS</b>						
TN3 45332	ø450	330	6830	+1020	6	0,09
TN3 45452	ø450	450	6830	+1020	7	0,13
<b>TRE NIVÅER THREE LEVELS</b>						
TN3 45333	ø450	330	7890	+1190	6	0,09
TN3 45453	ø450	450	7890	+1190	7	0,13



# TRAYO Anton Björnsing 2019

## Soff/Brickbord.

**L = Metallstativ lackat i standardfärger.**

**M = Metallstativ mattkrom.**

Tråringar formpressade i ek eller ask, standardbets på ask och vitpigmenterad ek, ask.

Runda skivor fanerad MDF i ek, ask, vit och svart laminat, standardbets på ask och vitpigmenterad på ek eller ask.

## Tillbehör:

Handtag lindat i Tärnslö läder col. 8175 svart eller col. 8695 brun.

Dolda hjul 4 stycken som monteras i nedersta brickan, ej låsbara.

Ange vid beställning artikelnummer, utförande på ring, skiva och metallstativ.

## Sofa/Tray table.

**L = Metal frame painted in standard colors.**

**M = Metal frame in matt chrome.**

The wooden rings are available in compression-moulded oak or ash, standard stains on ash and white-glazed oak or ash.

The round trays are in MDF, veneered with oak, ash, with white and black laminate, in standard stains on ash or white glazed oak or ash.

## Accessories:

Concealed four castors that can be fitted to the lower tray, not lockable.

Handles wrapped in black (col. 8175) or brown (col. 8695) leather from Tärnslö.

When ordering please enter article number and choice of finish for ring, tray and metal frame.



TR340L  
TR340M  
ø400 H 450



TR350L  
TR350M  
ø500 H 520

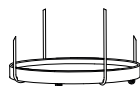

TRH  
Hjul 4st ej låsbara, +H10mm  
Castors 4pcs not lockable, +H10mm

Artno	Diameter mm	Höjd Height mm	Trayo SEK		Extra SEK		
			.10 ek oak .60 ek/vit laminat oak/white laminate .61 ek/svart laminat oak/black laminate	.30 ask ash .62 ask/vit laminat ash/white laminate .63 ask/svart laminat ash/black laminate	Standardbets på ask Standard stain on ash Vitpigment ek ask White glazed oak ash	Vikt brutto Weight gross kilos	Volym Volume
<b>Metallstativ lackat i standardfärger Metal frame painted in standard colors</b>							
TR340L	ø400	450	7450	6590	+630	5	0,1
TR350L	ø500	520	8480	7350	+740	6	0,17
<b>Metallstativ mattkrom Metal frame matt chrome</b>							
TR340M	ø400	450	7450	6590	+630	5	0,1
TR350M	ø500	520	8480	7350	+740	6	0,17
<b>Tillbehör Accessories</b>							
			<b>Tillbehör Accessories SEK</b>				
TRH Hjul, ej låsbara Castors, not lockable		+10	+1560				
TRL40-1 Handtag svart läder ø400 Handle black leather ø400			+2360				
TRL40-2 Handtag brunt läder ø400 Handle brown leather ø400			+2360				
TRL50-1 Handtag svart läder ø500 Handle black leather ø500			+2650				
TRL50-2 Handtag i brunt läder ø500 Handle in brown leather ø500			+2650				

SENAB

22% RABATT SKA DRAS AV PÅ ANGIVNA PRISER

# TRIO Ulla Christiansson 1998

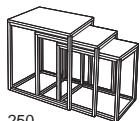

250

**Satsbord.** Massiv trä, klarlack.  
Bord levereras monterat.

*\*Utgående träslag med reservation för  
slutförsäljning*

**Nest of tables.** Solid wood, clear lacquer.  
Table comes pre-assembled.

*\*Outbound wood finish with reservation for  
end of stock.*

Artno	Längd Length mm	Bredd Width mm	Höjd Height mm	Trio SEK			Extra SEK		Vikt brutto Weight gross kilos	Volym Volume
				.10 ek oak .30 ask ash	*.15 bok beech .20 björk birch	*.43 körsbär cherry	Olja Oil	Olja+lack Oil+clear lacquer Standardbets på ask Standard stain on ash Vitpigment ek, ask White glazed oak or ash		
250	440/420/400	340/290/240	580/555/530	10630	10150	11790	+1060	+1600	10	0,13

# SHELL PALL STOOL

Note 2015



## SHPxxT

Träsits. Ben i massiv trä, klarlack. Filttass.

## SHPxxT

Wooden seat. Legs in solid wood, clear lacquer. Felt floor protection.

## SHPxxK

Klädd sits. Ben i massiv trä, klarlack. Filttass.  
Stafflad prisskala avser samma färg på tyg och träslag.  
För mönsterpassat tyg återkom för prisuppgift.

## SHPxxK

Seat upholstered. Legs in solid wood, clear lacquer. Felt floor protection.  
Staffed price scale refers to the same color of fabric and wood.  
For patterned fabric returned for price information.

Artno



SHP45T  
SHP45K

SHP70T  
SHP70K

SHP80T  
SHP80K

### Shell pall stool SEK

Artno	Bredd Width mm	Djup Depth mm	Höjd Height mm	Shell pall stool SEK		Extra SEK		Vikt netto Weight net kilos	Vikt brutto Weight gross kilos	Volym Volume
				.10 ek oak .20 björk birch .30 ask ash	.50 lack color	Standardbets på ask Standard stain on ash	Vitpigment ek ask White glazed oak ash			
<b>Träsits Wooden seat</b>										
SHP45T	370	413	450	4480	4920	+680		2,4	6	0,1
SHP70T	370	413	650	4810	5250	+730		2,8	7	0,15
SHP80T	370	413	800	5110	5580	+760		3,3	8	0,18

### Shell pall stool SEK

Artno	Bredd Width mm	Djup Depth mm	Höjd Height mm	Shell pall stool SEK						Extra SEK		Vikt netto Weight net kilos	Vikt brutto Weight gross kilos	Volym Volume
				.10 ek oak .20 björk birch .30 ask ash	.10 ek oak .20 björk birch .30 ask ash	.10 ek oak .20 björk birch .30 ask ash	.50 lack color	.50 lack color	.50 lack color	Standardbets på ask Standard stain on ash	Tygåtgång på 140 cm bredd Requirement of fabric width 140 cm			
<b>Klädd sits exkl. tyg eller läder Upholstered seat excl. fabric or leather</b>														
				1 styck pc	2-10 styck pc	11- styck pc	1 styck pc	2-10 styck pc	11- styck pc	per styck pc				
SHP45K	370	413	450	5450	4950	4730	6250	5230	5100	+640	50x90 cm	2,4	6	0,1
SHP70K	370	413	650	5750	5240	5050	6590	5580	5450	+690	50x90 cm	2,8	7	0,15
SHP80K	370	413	800	6030	5540	5360	6910	5880	5750	+740	50x90 cm	3,3	8	0,18

Extra Tyg Läder, Fabric Leather

SEK/styck pc	1 styck pc	2-10 styck pc	11- styck pc
Prisgrupp Pricegroup 1	+1220	+910	+660
Prisgrupp Pricegroup 2	+1370	+1060	+810
Prisgrupp Pricegroup 3	+1550	+1250	+1000
Prisgrupp Pricegroup 4	+1710	+1440	+1190
Standard läder leather	+1050	+1050	+1050

SENAB

22% RABATT SKA DRAS AV PÅ ANGIVNA PRISER



KARL ANDERSSON & SÖNER Cirkaprislista 2024 Vers.1

**MLPxxTTF** Sits och ben i massiv trä, klarlack. Filttass.  
**MLPxxTTFR** Rygg i trä. Sits och ben i massiv trä, klarlack. Filttass.

**MLPxxTTF** Seat and legs in solid wood, clear lacquer. Felt floor protection.  
**MLPxxTTFR** Back in wood. Seat and legs in solid wood, clear lacquer. Felt floor protection.

**MLPxxTKF** Klädd dyna. Sits och ben i massiv trä, klarlack. Filttass.  
**MLPxxTKFR** Rygg i trä. Klädd dyna. Sits och ben i massiv trä, klarlack. Filttass  
 Stafflad prisskala avser samma färg på tyg och träslag. För mönsterpassat tyg återkom för prisuppgift.

**MLPxxTKF** Cushion upholstred. Seat and legs in solid wood, clear lacquer. Felt floor protection.  
**MLPxxTKFR** Back in wood. Cushion upholstred. Seat and legs in solid wood, clear lacquer. Felt floor protection.  
 Staffed price scale refers to the same color of fabric and wood. For patterned fabric returned for price information.



Artno	Bredd Width mm	Djup Depth mm	Höjd Height mm	Sitthöjd Seat height mm	Milo SEK		Extra SEK						
					.10 ek oak .30 ask ash	Standardbets på ask Standard stain on ash Vitpigment ek ask White glazed oak ash	Snurrfunktion max 130kg Swivel max 130kg	Fotplåt Foot rest MLPFPs = svart black MLPFPv = vit white	Fotplåt Foot rest MLPFPPr = rostfri stål stainless steel	Vikt netto Weight net kilos	Vikt brutto Weight gross kilos	Volym Volume	
<b>Träsits Wooden seat</b>													
MLP65 TTF	350	350 ø390	650		5320	+810	+150	+560	+690	6	10	0,12	
MLP75 TTF	350	350 ø390	750		5380	+810	+150	+560	+690	6	10	0,17	
<b>Rygg. Träsits. Back. Wooden seat.</b>													
MLP65 TTFR	350	350 ø390/370	870	650	7170	+1070	+150	+560	+690	7	11	0,15	
MLP75 TTFR	350	350 ø390/370	970	750	7230	+1070	+150	+560	+690	7	11	0,20	

Artno	Bredd Width mm	Djup Depth mm	Höjd Height mm	Sitthöjd Seat height mm	Milo SEK			Extra SEK							
					.10 ek oak .30 ask ash	.10 ek oak .30 ask ash	.10 ek oak .30 ask ash	Standardbets på ask Standard stain on ash Vitpigment ek ask White glazed oak ash	Snurrfunktion max 130kg Swivel max 130kg	Fotplåt Foot rest MLPFPs = svart black MLPFPv = vit white	Fotplåt Foot rest MLPFPPr = rostfri stål stainless steel	Tygåtgång på 140 cm bredd Requirement of fabric width 140 cm	Vikt netto Weight net kilos	Vikt brutto Weight gross kilos	Volym Volume
<b>Klädd dyna exkl. tyg eller läder Upholstred cushion excl. fabric or leather</b>															
MLP65 TKF	350	350 ø390	650		6340	6290	6150	+810	+150	+560	+690	50 cm	6	10	0,12
MLP75 TKF	350	350 ø390	750		6400	6340	6200	+810	+150	+560	+690	50 cm	6	10	0,17
<b>Rygg. Klädd dyna exkl. tyg eller läder Back. Upholstred cushion, excl. fabric or leather</b>															
MLP65 TKFR	350	350 ø390/370	870	650	8190	8120	7990	+1070	+150	+560	+690	50 cm	7	11	0,15
MLP75 TKFR	350	350 ø390/370	970	750	8260	8190	8070	+1070	+150	+560	+690	50 cm	7	11	0,20

**Extra Tyg Läder, Fabric Leather**

SEK/styck pc	1 styck pc	2-10 styck pc	11- styck pc
Prisgrupp Pricegroup 1	+1220	+610	+390
Prisgrupp Pricegroup 2	+1370	+690	+470
Prisgrupp Pricegroup 3	+1550	+780	+570
Prisgrupp Pricegroup 4	+1740	+870	+670
Standard läder leather	+450	+450	+450

**Pall**  
Sits i massiv trä, klarlack. Ben i metall, ytbehandling i  
\*mattkrom eller \*\*svartlack. Filttass.

**Stool**  
Seat in solid wood, clear lacquer. Legs in metal, finish  
\*matchchrome or \*\*black lacquer. Felt floor protection.

Artno



KAZP45M\*  
KAZP45S\*\*



KAZP65M\*  
KAZP65S\*\*



KAZP80M\*  
KAZP80S\*\*

Artno	Bredd Width mm	Djup Depth mm	Höjd Height mm	Kaz SEK	Extra SEK	Vikt netto Weight net kilos	Vikt brutto Weight gross kilos	Volym Volume
				.10 ek oak .30 ask ash	Standardbets på ask Standard stain on ash  Vitpigment ek, ask White glazed oak, ash			
KAZP45M	440	365	450	4360	+370	4	6	0,1
KAZP45S	440	365	450	4360	+370	4	6	0,1
KAZP65M	440	405	650	4690	+370	5	8	0,15
KAZP65S	440	405	650	4690	+370	5	8	0,15
KAZP80M	440	405	800	4850	+370	6	9	0,18
KAZP80S	440	405	800	4850	+370	6	9	0,18

# COLO CHAIR kaschkasch 2022



Den flexibla och fällbara stolen Colo Chair är stativet i massivt trä med formpressad sits och rygg i trä. Samtliga beslag är i rostfritt stål. Träslagen är ek, ask, standardbetser på ask och vitpigmenterad ek eller ask. Benen är försedd med filtassar. Som tillval finns klädd dyna i tyg eller läder, kopplingsbeslag och upphängningsbeslag i massivträ lika utförande som stolen. Maxantal två stycken per upphängningsbeslag. Transportvagn med låsbara hjul och metallhandtag i svart finns för 12 stolar. I hopfällt läge är staplingsmättet är 72 mm. Med hjälp av handverktyg är det enkelt att separera alla delar av stolen.

The flexible and folding Colo Chair is made in solid wood frame supports a compression-pressed wooden seat and backrest. All fittings are made of stainless steel. Choose from oak or ash, standard stains on ash, or white glaze on oak or ash. The legs have felt floor protectors. Optional extras are seat pads covered in fabric or leather, link fittings and solid wood suspension brackets in the same finish as the chair. Maximum two chairs per bracket. A trolley in a black finish with metal handles and locking wheels is also available for storing and transporting up to 12 chairs. Each chair folds to a maximum of 72 mm. The appropriate hand tools are all that is required to simply separate each chair into its component parts.

## Tillbehör Accessories

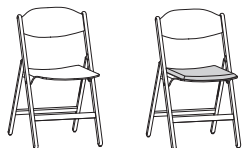

CC1

CC2



CCU2  
D160 ø38  
Upph.beslag max 2 stolar  
Suspen.bracket max. 2 chairs



CCK  
Koppl.beslag distans 40mm  
rostfri  
Link fittings distance 40mm  
stainless

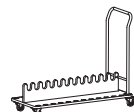

CCV1  
Vagn max 12 stolar, svart  
Trolley max 12 chairs, black

Artno	Bredd Width mm	Djup Depth mm	Höjd Height mm	Sitthöjd Seat Height mm	Colo Chair SEK		Extra SEK				
					.10 ek oak	.30 ask ash	Standardbets på ask Standard stain on ash	Vikt netto Weight net kilos	Vikt brutto Weight gross kilos	Volym Volume	
<b>Träsits Wooden seat</b>											
CC1	460	540	815	465	4380	4130	+610	3,4	5	0,05	
<b>Tillbehör Accessories for CC1 and CC2</b>											
CCU2		160/ø38			540	540	+70				
CCK rostfri stainless	40				350 rostfri stainless						
CCV1 svart black	500	1250	1015		6740 svart black						

Artno	Bredd Width mm	Djup Depth mm	Höjd Height mm	Sitthöjd Seat Height mm	Colo Chair SEK						Extra SEK				
					.10 ek oak	.10 ek oak	.10 ek oak	.30 ask ash	.30 ask ash	.30 ask ash	Standardbets på ask Standard stain on ash	Tygåtgång på 140 cm bredd Requirement of fabric width 140 cm	Vikt netto Weight net kilos	Vikt brutto Weight gross kilos	Volym Volume
<b>Klädd sits exkl. tyg eller läder Upholstred seat excl. fabric or leather</b>					1 pc	2-10 pc	11- pc	1 pc	2-10 pc	11- pc	per styck pc				
CC2	460	540	815	480	5570	5530	5410	5310	5280	5160	+610	50x45 cm	4,3	6	0,06

SEK/styck pc	1 styck pc	2-10 styck pcs	11- styck pcs
Prisgrupp Pricegroup 1	+1220	+610	+280
Prisgrupp Pricegroup 2	+1370	+690	+330
Prisgrupp Pricegroup 3	+1550	+780	+400
Prisgrupp Pricegroup 4	+1740	+870	+470
Standard läder leather	+550	+550	+550

SENAB

**22% RABATT SKA DRAS AV PÅ ANGIVNA PRISER**



# SHELL STOL CHAIR Note 2018



## SHST45T träsis. SHST45T wooden seat

Legs in solid wood incl. felt floor protection. Clear lacquer.

## SHST45S klädd sits. SHST45S covered seat

Legs in solid wood incl. felt floor protection. Clear lacquer. Staffed price scale refers to the same color of fabric and wood. For patterned fabric returned for price information.

## SHST45K klädd sits och rygg. SHST45K fully upholstered

Legs in solid wood incl. felt floor protection. Clear lacquer. Staffed price scale refers to the same color of fabric and wood. For patterned fabric returned for price information.

## SHST45T träsis.

Ben i massiv trä, klarlack inkl. filtass.

## SHST45S klädd sits.

Ben i massiv trä, klarlack inkl. filtass. Stafflad prisskala avser samma färg på tyg och träslag. För mönsterpassat tyg återkom för prisuppgift.

## SHST45K klädd sits och rygg.

Ben i massiv trä, klarlack inkl. filtass. Stafflad prisskala avser samma färg på tyg och träslag. För mönsterpassat tyg återkom för prisuppgift.

Artno



SHST45T



SHST45S



SHST45K

Artno	Shell stol chair SEK				Extra SEK			Standardbets på ask Standard stain on ash  Vitpigment ek ask White glazed oak ash	Vikt netto Weight net kilos	Vikt brutto Weight gross kilos	Volym Volume
	Bredd Width mm	Djup Depth mm	Höjd Height mm	Sitthöjd Seat Height mm	.10 ek oak .30 ask ash	.20 björk birch	.50 lack color				
SHST45T	405	525	825	455	5530	4920	5370	+820	4	6	0,28

Artno	Shell stol chair SEK												Extra SEK					
	Bredd Width mm	Djup Depth mm	Höjd Height mm	Sitthöjd Seat Height mm	.10 ek oak .30 ask ash	.10 ek oak .30 ask ash	.10 ek oak .30 ask ash	.20 björk birch	.20 björk birch	.20 björk birch	.50 lack color	.50 lack color	.50 lack color	Standardbets på ask Standard stain on ash  Vitpigment ek ask White glazed oak ash	Tygåtgång på 140 cm bredd Requirement of fabric width 140 cm	Vikt netto Weight net kilos	Vikt brutto Weight gross kilos	Volym Volume
SHST45S	405	525	825	455	6900	6860	6710	6290	6230	6120	6720	6690	6560	+820	50x46 cm	5	7	0,28
SHST45K	405	525	825	455	8380	7040	6820	8260	6910	6700	8510	7180	6970	+360	75 cm	4	6	0,28

### Extra Tyg Läder, Fabric Leather SHST45S klädd sits upholstred seat

SEK/styck pc	1 styck pc	2-10 styck pcs	11- styck pcs
Prisgrupp Pricegroup 1	+1220	+610	+280
Prisgrupp Pricegroup 2	+1370	+690	+330
Prisgrupp Pricegroup 3	+1550	+780	+400
Prisgrupp Pricegroup 4	+1740	+870	+470
Standard läder leather	+580	+580	+580

### Extra Tyg Läder, Fabric Leather SHST45K klädd sits och rygg fully upholstred

SEK/styck pc	1 styck pc	2-10 styck pcs	11- styck pcs
Prisgrupp Pricegroup 1	+1820	+1210	+970
Prisgrupp Pricegroup 2	+2120	+1440	+1190
Prisgrupp Pricegroup 3	+2490	+1720	+1480
Prisgrupp Pricegroup 4	+2870	+2000	+1760
Standard läder leather	+2390	+2390	+2390

### Pall.

Underrede och ben i massiv trä inkl. filtassar. Ytbehandling klarlack.  
 Stoppning kallskum klädd exkl. tyg/läder. Tillbehör bord diam 260mm och USB.  
 Pall levereras monterad. Vid beställning ange artikelnummer, utförande och klädsel.

### Stool.

Base in solid wood incl. felt protection. Finish clear lacquer.  
 Upholstered excl. fabric/leather. Seat in cold-cured foam.  
 The stool comes pre-assembled. When ordering article number, execution and name of fabric/leather.

### Artno



HY370



HY390

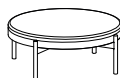

HY3120

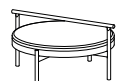

HY390-A  
incl. armstöd/rygg  
armrest/back

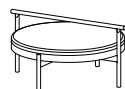

HY3120-A  
incl. armstöd/rygg  
armrest/back

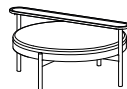

HY3120-5  
incl. långt bord  
long table

### Tillbehör / Accessories



Bord Table diam 260mm  
 Antal bord per pall/artno  
 Numbers of table per stool/art.no

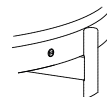

TKB18 USB  
 Svart. Placeras på ramen vid sidan av ben.  
 Black. Placed on the side of the leg.

HY370-1 = 1st pc HY370  
 HY390-1 = 1st pc HY390  
 HY390-2 = 2st pc HY390  
 HY3120-1 = 1st pc HY3120  
 HY3120-2 = 2st pc HY3120  
 HY3120-3 = 3st pc HY3120  
 HY3120-4 = 4st pc HY3120

Hygge SEK	Extra SEK
-----------	-----------

Artno	Diam mm	Höjd Height mm	.10 ek oak .30 ask ash	Standardbets på ask Standard stain on ash Vitpigment ek ask White glazed oak ash	Tyg Fabric Prisgrupp Pricegroup 1	Tyg Fabric Prisgrupp Pricegroup 2	Tyg Fabric Prisgrupp Pricegroup 3	Tyg Fabric Prisgrupp Pricegroup 4	Standard läder Leather	Tygåtgång på 140 cm bredd Requirement of fabric width 140 cm	Vikt brutto Weight gross kilos	Volym Volume
HY370	780/700	460	11000	+1650	+1700	+1970	+2300	+2640	+1730	90 cm	35	0,45
HY390	980/900	460	12190	+1830	+1940	+2270	+2680	+3090	+2280	110 cm	55	0,8
HY3120	1280/1200	460	13770	+2070	+2300	+2720	+3240	+3770	+4370	140 cm	70	1,09
HY390-A	980/900 Armstöd/Armrest H680 L1080 ø40	460	14450	+2180	+1940	+2270	+2680	+3090	+2280	110 cm	71	1,2
HY3120-A	1280/1200 Armstöd/Armrest H680 L1380 ø40	460	15890	+2390	+2300	+2720	+3240	+3770	+4370	140 cm	71	1,2
HY3120-5	1280/1200 Långt bord/Long table H680 L1140 W195	460	18510	+2780	+2300	+2720	3240	+3770	+4370	140 cm	76	1,2
<b>Tillbehör Accessories</b>												
HY370-1	Bord Table diam 260	680	2100	+210								
HY390-1	Bord Table diam 260	680	2100	+210								
HY390-2	Bord Table diam 260	680	4190	+410								
HY3120-1	Bord Table diam 260	680	2100	+210								
HY3120-2	Bord Table diam 260	680	4190	+410								
HY3120-3	Bord Table diam 260	680	6300	+630								
HY3120-4	Bord Table diam 260	680	8380	+830								
TKB18	USB svart black		1040 svart black									

# SANDER CONFERENCE Roger Persson 2021-2023



## Sander Conference

Träslag: ek, ask, standardbetser på ask och vitpigmenterad ek eller ask.

Underrede: Ben i massiv trä inkl. fittass.

4-kryssföt i metall i färg svart pulverlack eller mattpolerad, sits alltid höj- och sänkbar och snurrbar. Fittass för hårda ytor eller plaststass för mjuka ytor

Hjul ej låsbara, i färg svart pulverlack eller mattpolerad. Är snurrbar och välj mellan fast eller höj- och sänkbar sits.

Fätöj finns med eller utan armstöd. Armstöd i massivt trä.

Fätöjen sits och rygg kan kläs i tyg, läder, konstläder eller efter önskemål. Rekommendation är att välja ett tyg som är tvätt- och stretchbart. Tyger generell bör vara något tåjbara. Randiga och rutiga mönster bör undvikas. Tillval: avtagbar klädsel på sits.

Fätöjen levereras monterad. Med hjälp av handverktyg är det enkelt att separera ryggskået från benstativ och vid en eventuell omklädsel skruvas rygg och sits enkelt bort.

Ange vid beställning: artikelnummer, utförande på trä, tyg, läder samt tass för metallstativ.

## MÖBELFAKTA

### Sander Conference

Wood: oak, ash, standard stains on ash and white glazed on oak or ash.

Base: Legs in solid wood incl. felt feet.

4-star base in metal, color black powder coating or matte polished, equipped with felt feet for hard surfaces or plastic feet for soft surfaces. Adjustable height and swivel.

Wheel stand (not lockable). in black powder coating or matte polished. All chairs are swivel and choose between a fixed or adjustable height.

Sander Conference available with or without armrest. Armrest in solid wood

The seat and back may be covered in a fabric of choice or real or synthetic leather, according to customer wishes.

Fabrics should generally be somewhat stretchable. Avoid striped/checkered patterns. A removable seat cover with an interliner of hospital-grade fabric or lining cloth is available as an optional extra, recommendation is to choose a fabric that is washable and stretchable. The easy chair is supplied assembled. Hand tools are all that is needed to simply detach the back shell from the leg frame. It is a simple matter to separate seat and back, if the chair is to be re-covered.

State when ordering: article number, finish of wood, fabric, leather and feet on the 4-star base.

## Artno Sander Conference



Klädd sits.  
Upholstered seat.  
SAF500



Klädd sits, höj/sänkbar.  
Upholstered seat, adjustable height.  
SAF504s = black  
SAF504p = matt polished



Klädd sits, fast höjd.  
Upholstered seat, fixed height.  
SAF506s = black  
SAF506p = matt polished



Klädd sits, höj/sänkbar.  
Upholstered seat, adjustable height.  
SAF508s = black  
SAF508p = matt polished



Klädd sits  
Upholstered seat  
SAF600



Klädd sits, höj/sänkbar.  
Upholstered seat, adjustable height  
SAF604s = black  
SAF604p = matt polished



Klädd sits, fast höjd  
Upholstered seat, fixed height  
SAF606s = black  
SAF606p = matt polished



Klädd sits, höj/sänkbar  
Upholstered seat, adjustable height  
SAF608s = black  
SAF608p = matt polished



Klädd sits och rygg.  
Upholstered seat and back.  
SAF510



Klädd sits och rygg, höj/sänkbar.  
Upholstered seat and back, adjustable height.  
SAF514s = black  
SAF514p = matt polished



Klädd sits och rygg, fast höjd.  
Upholstered seat and back, fixed height  
SAF516s = black  
SAF516p = matt polished



Klädd sits och rygg, höj/sänkbar  
Upholstered seat and back, adjustable height.  
SAF518s = black  
SAF518p = matt polished



Klädd sits och rygg.  
Upholstered seat and back.  
SAF610



Klädd sits och rygg, höj/sänkbar  
Upholstered seat and back, adjustable height.  
SAF614s = black  
SAF614p = matt polished



Klädd sits och rygg, fast höjd.  
Upholstered seat and back, fixed height.  
SAF616s = black  
SAF616p = matt polished



Klädd sits och rygg, höj/sänkbar.  
Upholstered seat and back, adjustable height.  
SAF618s = black  
SAF618p = matt polished

### Extra Tyg Läder, Fabric Leather

Klädd sits Upholstered seat

Artno SAF500, SAF504, SAF506, SAF508, SAF600, SAF604, SAF606, SAF608

SEK/styck pcs	1 styck pc	2-10 styck pcs	11- styck pcs
Prisgrupp Pricegroup 1	+1460	+730	+520
Prisgrupp Pricegroup 2	+1670	+840	+630
Prisgrupp Pricegroup 3	+1930	+970	+780
Prisgrupp Pricegroup 4	+2190	+1100	+920
Standard läder leather	+970	+970	+970

### Extra Tyg Läder, Fabric Leather

Klädd sits och rygg Upholstered seat and back

Artno SAF510, SAF514, SAF516, SAF518, SAF610, SAF614, SAF616, SAF618

SEK/styck pcs	1 styck pc	2-10 styck pcs	11- styck pcs
Prisgrupp Pricegroup 1	+1460	+1150	+900
Prisgrupp Pricegroup 2	+1670	+1360	+1110
Prisgrupp Pricegroup 3	+1930	+1620	+1370
Prisgrupp Pricegroup 4	+2190	+1890	+1640
Standard läder leather	+1900	+1900	+1900

# SANDER CONFERENCE Roger Persson 2023



## Sander Conference SEK

## Extra SEK

Artno	Bredd Width mm	Djup Depth mm	Höjd Height mm	Sithöjd Seat height mm	Armstöd Armrest höjd height mm	.10 ek oak .30 ask ash	.10 ek oak .30 ask ash	.10 ek oak .30 ask ash	Standardbets på ask Standard stain on ash Vitpigment ek ask White glazed oak ash	Avtagbar klädsel på sits, urinröv Removable cover on seat, an interliner of hospital-grade	Avtagbar klädsel på sits, domestik Removable cover on seat, lining cloth	Tygåtgång på 140 cm bredd Requirement of fabric width 140 cm	Höj-sänkbar sits Adjustable seat	Vikt netto Weight net kilos	Vikt brutto Weight gross kilos	Volym Volume
<b>utan armstöd excl. armrest</b>						<b>1 styck pc</b>	<b>2-10 styck pcs</b>	<b>11- styck pcs</b>	<b>per styck each</b>	<b>per styck each</b>	<b>per styck each</b>					
SAF500	550	640	820	470		9910	9700	9570	+1170	+1040	+910	70 cm	---	9	13	0,34
SAF504s	550	640	800/925	415/540		10720	10500	10380	+950	+1040	+910	70 cm	YES	14	18	0,33
SAF504p	550	640	800/925	415/540		10910	10700	10570	+950	+1040	+910	70 cm	YES	14	18	0,33
SAF506s	550	640	850	460		10820	10610	10480	+950	+1040	+910	70 cm	---	14	18	0,35
SAF506p	550	640	850	460		11200	10990	10870	+950	+1040	+910	70 cm	---	14	18	0,35
SAF508s	550	640	840/965	460/585		10820	10610	10480	+950	+1040	+910	70 cm	YES	14	18	0,35
SAF508p	550	640	840/965	460/585		11200	10990	10870	+950	+1040	+910	70 cm	YES	14	18	0,35
SAF510	550	640	820	470		11990	11660	11440	+950	+1040	+910	70 cm	---	9	13	0,34
SAF514s	550	640	800/925	415/540		12790	12470	12240	+900	+1040	+910	70 cm	YES	14	18	0,33
SAF514p	550	640	800/925	415/540		12990	12660	12430	+900	+1040	+910	70 cm	YES	14	18	0,33
SAF516s	550	640	850	460		12900	12570	12350	+900	+1040	+910	70 cm	---	14	18	0,35
SAF516p	550	640	850	460		13280	12950	12730	+900	+1040	+910	70 cm	---	14	18	0,35
SAF518s	550	640	840/965	460/585		12900	12570	12350	+900	+1040	+910	70 cm	YES	14	18	0,35
SAF518p	550	640	840/965	460/585		13280	12950	12730	+900	+1040	+910	70 cm	YES	14	18	0,35
<b>med armstöd incl. armrest</b>																
SAF600	600	640	820	470	615	10880	10660	10540	+1220	+1040	+910	70 cm	---	10	14	0,34
SAF604s	600	640	800/925	415/540	560/685	11680	11470	11340	+1010	+1040	+910	70 cm	YES	15	19	0,33
SAF604p	600	640	800/925	415/540	580/685	11870	11660	11530	+1010	+1040	+910	70 cm	YES	15	19	0,33
SAF606s	600	640	850	460	605	11280	11070	10940	+1010	+1040	+910	70 cm	---	15	19	0,35
SAF606p	600	640	850	460	605	12170	11960	11830	+1010	+1040	+910	70 cm	---	15	19	0,35
SAF608s	600	640	840/965	460/585	605/730	11790	11580	11450	+1010	+1040	+910	70 cm	YES	15	19	0,35
SAF608p	600	640	840/965	460/585	605/730	12170	11960	11830	+1010	+1040	+910	70 cm	YES	15	19	0,35
SAF610	600	640	820	470	615	12950	12620	12400	+1010	+1040	+910	70 cm	---	10	14	0,34
SAF614s	600	640	800/925	415/540	560/685	13760	13430	13210	+950	+1040	+910	70 cm	YES	15	19	0,33
SAF614p	600	640	800/925	415/540	560/685	13950	13620	13400	+950	+1040	+910	70 cm	YES	15	19	0,33
SAF616s	600	640	850	460	605	13860	13540	13310	+950	+1040	+910	70 cm	---	15	19	0,35
SAF616p	600	640	850	460	605	14250	13920	13700	+950	+1040	+910	70 cm	---	15	19	0,35
SAF618s	600	640	840/965	460/585	605/730	13860	13540	13310	+950	+1040	+910	70 cm	YES	15	19	0,35
SAF618p	600	640	840/965	460/585	605/730	14250	13920	13700	+950	+1040	+910	70 cm	YES	15	19	0,35

Pris Tyg Läder | Price Fabric Leather see page 67

# SENAB

## 22% RABATT SKA DRAS AV PÅ ANGIVNA PRISER

## Sander Lounge

Träslag: ek, ask, standardbetsler på ask och vitpigmenterad ek eller ask.  
 Underrede: Ben i massiv trä inkl. filtass. 4-Kryssfot i metall, färg svart pulverlack eller mattpolerad, är snurrbar och har återgång av sits. (Ej hög- och sänkbar). Kryssfot är försedd med filtass för hårda ytor eller plastass för mjuka ytor.  
 Finns med eller utan armstöd.

Fätöljens sits och rygg kan kläs i tyg, läder, konstläder eller efter önskemål. Rekommendation är att välja ett tyg som är tvätt- och stretchbart. Tyger generellt bör vara något tójbara. Randiga och rutiga mönster bör undvikas.

Tillval: avtagbar klädsel på sits.

Fätöljen levereras monterad. Med hjälp av handverktyg är det enkelt att separera ryggskalet från benstativ och vid en eventuell omklädsel skruvas rygg och sits enkelt bort.

Ange vid beställning: artikelnummer, utförande på trä, tyg, läder samt tass för metallstativ.

## Sander Lounge

Wood: oak, ash, standard stains on ash and white glazed on oak or ash.

Base: Legs in solid wood incl. felt feet. 4-star base in metal black powder coating or matte polished, has swivel and a reversible seat, (not adjustable). The 4-star base is equipped with felt feet for hard surfaces or plastic feet for soft surfaces.

Available with or without armrest.

The seat and back may be covered in a fabric of choice or real or synthetic leather, according to customer wishes.

Fabrics should generally be somewhat stretchable. Avoid striped/checkered patterns. A removable seat cover with an interliner of hospital-grade fabric or lining cloth is available as an optional extra, recommendation is to choose a fabric that is washable and stretchable.

The easy chair is supplied assembled. Hand tools are all that is needed to simply detach the back shell from the leg frame. It is a simple matter to separate seat and back, if the chair is to be re-covered.

State when ordering: article number, finish of wood, fabric, leather and feet protection of 4-star base.

### Artno Sander Lounge



Klädd sits  
Upholstered seat  
SAF100



Klädd sits  
Upholstered seat  
SAF101s = black  
SAF101p = matt polished



Klädd sits  
Upholstered seat  
SAF200



Klädd sits  
Upholstered seat  
SAF201s = black  
SAF201p = matt polished



Klädd sits och rygg  
Upholstered seat and back  
SAF110



Klädd sits och rygg  
Upholstered seat and back  
SAF111s = black  
SAF111p = matt polished



Klädd sits och rygg  
Upholstered seat and back  
SAF210



Klädd sits och rygg  
Upholstered seat and back  
SAF211s = black  
SAF211p = matt polished

Artno	Bredd Width mm	Djup Depth mm	Höjd Height mm	Sithöjd Seat height mm	Armstöd Armrest höjd height mm	Sander Lounge SEK			Extra SEK			Tytgång på 140 cm bredd Requirement of fabric width 140 cm	Vikt netto Weight net kilos	Vikt brutto Weight gross kilos	Volym Volume
						.10 ek oak .30 ask ash	.10 ek oak .30 ask ash	.10 ek oak .30 ask ash	Standardbets på ask Standard stain on ash Vitpigment ek ask White glazed oak ash	Avtagbar klädsel på sits, urinröv Removable cover on seat, an interliner of hospital-grade	Avtagbar klädsel på sits, domestik Removable cover on seat, lining cloth				
<b>utan armstöd excl. armrest</b>						<b>1 styck pc</b>	<b>2-10 styck pcs</b>	<b>11- styck pcs</b>	<b>per styck each</b>	<b>per styck each</b>	<b>per styck each</b>				
SAF100	550	640	780	430		9860	9650	9520	+1170	+1040	+910	70 cm	9	13	0,34
SAF101s	550	640	800	425		11030	10820	10700	+950	+1040	+910	70 cm	14	18	0,33
SAF101p	550	640	800	425		11230	11010	10890	+950	+1040	+910	70 cm	14	18	0,33
SAF110	550	640	780	430		11940	11610	11380	+950	+1040	+910	70 cm	9	13	0,34
SAF111s	550	640	800	425		13110	12780	12560	+900	+1040	+910	70 cm	14	18	0,33
SAF111p	550	640	800	425		13300	12970	12750	+900	+1040	+910	70 cm	14	18	0,33
<b>med armstöd incl. armrest</b>															
SAF200	655	640	780	430	575	10820	10610	10480	+1220	+1040	+910	70 cm	10	14	0,34
SAF201s	655	640	800	425	570	12000	11790	11660	+1010	+1040	+910	70 cm	15	19	0,33
SAF201p	655	640	800	425	570	12190	11980	11850	+1010	+1040	+910	70 cm	15	19	0,33
SAF210	655	640	780	430	575	12900	12570	12350	+1010	+1040	+910	70 cm	10	14	0,34
SAF211s	655	640	800	425	570	14080	13750	13530	+950	+1040	+910	70 cm	15	19	0,33
SAF211p	655	640	800	425	570	14270	13940	13720	+950	+1040	+910	70 cm	15	19	0,33

### Extra Tyg Läder, Fabric Leather

Klädd sits Upholstered seat

Artno SAF100, SAF101, SAF200, SAF201

SEK/styck pcs	1 styck pc	2-10 styck pcs	11- styck pcs
Prisgrupp Pricegroup 1	+1460	+730	+520
Prisgrupp Pricegroup 2	+1670	+840	+630
Prisgrupp Pricegroup 3	+1930	+970	+780
Prisgrupp Pricegroup 4	+2190	+1100	+920
Standard läder leather	+970	+970	+970

### Extra Tyg Läder, Fabric Leather

Klädd sits och rygg Upholstered seat and back

Artno SAF110, SAF111, SAF210, SAF211

SEK/styck pcs	1 styck pc	2-10 styck pcs	11- styck pcs
Prisgrupp Pricegroup 1	+1460	+1150	+900
Prisgrupp Pricegroup 2	+1670	+1360	+1110
Prisgrupp Pricegroup 3	+1930	+1620	+1370
Prisgrupp Pricegroup 4	+2190	+1890	+1640
Standard läder leather	+1900	+1900	+1900

## Soff-/Bänk system.

Meander består av rak soffa och bänk i tre olika längder, samt kurvade delar i 45 och 90 graders vinkel. Soffans rygg är böjd antingen som en inner- eller ytterdel. Alla gavlar är förberedda för förankring i golv. Soffa och bänk kan kopplas samman, förses med armstöd och eluttag. Träslagen är ek, ask, standardbetsler på ask och vitpigmenterad ek eller ask. Meander levereras monterad. Om skada uppstår på sits eller rygg går det enkelt att skruva loss med handverktyg och byta ut eller slipa om.

## Sofa/Bench system.

Meander comprises a straight sofa and bench in three different lengths, complemented by curved modules with 45° and 90° angles. The sofa's backrest follows the curved inner or outer lines of the sofa. All end sections are prepared so that they can be anchored to the floor. Sofa and bench sections can be linked and fitted with armrests or electric outlets. Choose from oak, ash, standard stains on ash, or white glaze on oak or ash. Meander is supplied assembled. Any damage sustained to seat or backrest can simply be repaired by unscrewing the element in question with a hand tool and replacing it or sanding down the affected area.

### Artno SOFFA RAK SOFA STRAIGHT

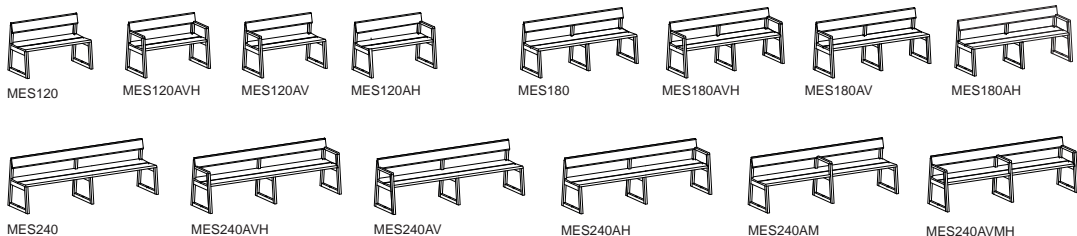

### Artno BÄNK RAK BENCH STRAIGHT

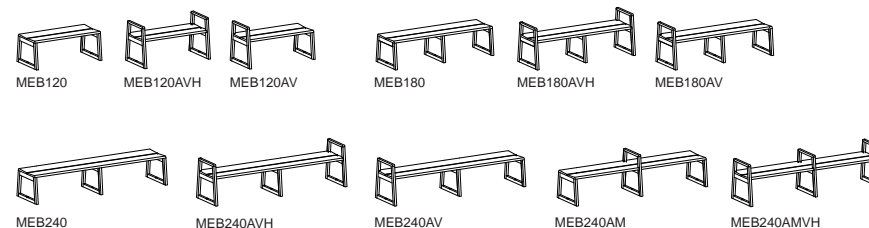

### SOFFA SOFA INNER 45°



### SOFFA YTTRE SOFA OUTER 45°



### SOFFA SOFA INNER 90°

endast för koppling eller fästas i golv  
only for connecting or secured into floor



### SOFFA YTTRE SOFA OUTER 90°

endast för koppling eller fästas i golv  
only for connecting or secured into floor



### BÄNK BENCH 45°

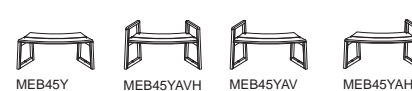

### BÄNK BENCH 90°

endast för koppling eller fästas i golv  
only for connecting or secured into floor

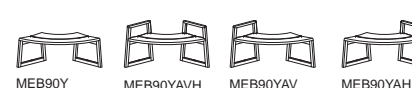

### FÖRSLAG SUGGESTIONS

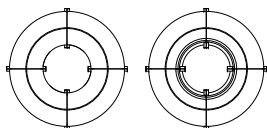

4 x MEB90Y  
diam 1920/650

4 x MES90Y  
diam 1920/650



1xMES45YAV, 2xMES45I, 1xMES45Y, 1xMES45YAH  
L5175 W740



1xMES90YAV, 2xMES90I, 1xMES90Y, 1xMES90YAH  
L5005 W920

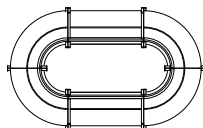

2xMES120AVH, 4xMES90Y  
L3120 W1920 innermått inner L1850 W650

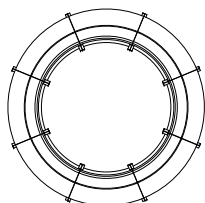

8 x MES45Y  
diam 3220/1940

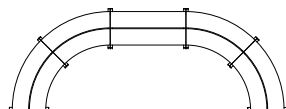

1xMEB120, 1xMES120, 1xMEB120AVH, 1xMES120AV  
L3940 W1830

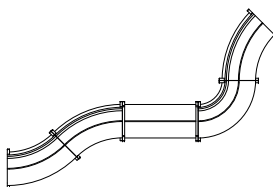

1xMES120, 2xMES120, 1xMEB120AVH, 1xMES120AV  
L4280 W2850

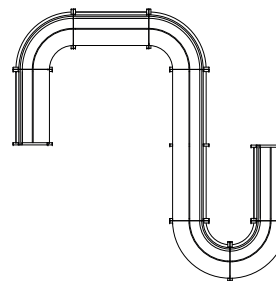



1xMES120AV, 2xMES90I, 1xMES120, 1xMES240, 2xMES90Y, 1xMES120AH  
L4420 W4330

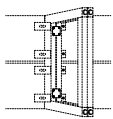

Artno	Längd Length mm	Djup Depth mm	Höjd Height mm	Sithöjd Seat height mm	Meander SEK		Vikt netto Weight net kilos	Vikt brutto Weight gross kilos	Volym Volume
					.10 ek oak .30 ask ash	Standardbets på ask Standard stain on ash Vitpigment ek ask White glazed oak ash			
<b>SOFFA RAK SOFA STRAIGHT</b>									
MES120	1200	625	800	470	13060	+1950	20	50	0,42
MES120AVH	1200	625	800	470	13890	+2090	22	52	0,42
MES120AV	1200	625	800	470	13470	+2010	21	51	0,42
MES120AH	1200	625	800	470	13470	+2010	21	51	0,42
MES180	1800	625	800	470	19390	+2920	32	70	0,67
MES180AVH	1800	625	800	470	20210	+3020	34	72	0,67
MES180AV	1800	625	800	470	19800	+2980	33	71	0,67
MES180AH	1800	625	800	470	19800	+2980	33	71	0,67
MES240	2400	625	800	470	22540	+3380	38	80	0,82
MES240AVH	2400	625	800	470	23370	+3520	40	82	0,82
MES240AV	2400	625	800	470	22960	+3540	39	81	0,82
MES240AH	2400	625	800	470	22960	+3540	39	81	0,82
MES240AM	2400	625	800	470	22960	+3540	39	81	0,82
MES240AVMH	2400	625	800	470	23800	+3560	41	82	0,82
<b>SOFFA SOFA 45 °</b>									
MES45I	1225/750	625	800	470	18240	+2750	19	50	0,42
MES45IAV	1220/750	625	800	470	18680	+2800	20	51	0,42
MES45IAH	1220/750	625	800	470	18680	+2800	20	51	0,42
MES45Y	1225/750	625	800	470	17570	+2630	19	50	0,42
MES45YAVH	1225/750	625	800	470	18410	+2770	22	52	0,42
MES45YAV	1225/750	625	800	470	17990	+2700	20	51	0,42
MES45YAH	1225/750	625	800	470	17990	+2700	20	51	0,42
<b>SOFFA SOFA 90 °</b>									
MES90I	1350/475	625	800	470	19490	+2930	20	51	0,53
MES90IAV	1350/475	625	800	470	19910	+2990	21	52	0,53
MES90IAH	1350/475	625	800	470	19910	+2990	21	52	0,53
MES90Y	1350/475	625	800	470	18030	+2700	19	50	0,53
MES90YAVH	1350/475	625	800	470	18870	+2830	21	52	0,53
MES90YAV	1350/475	625	800	470	18450	+2770	20	51	0,53
MES90YAH	1350/475	625	800	470	18450	+2770	20	51	0,53

Artno	Längd Length mm	Djup Depth mm	Höjd Height mm	Sithöjd Seat height mm	Meander SEK		Vikt netto Weight net kilos	Vikt brutto Weight gross kilos	Volym Volume
					.10 ek oak .30 ask ash	Standardbets på ask Standard stain on ash Vitpigment ek ask White glazed oak ash			
<b>BÄNK RAK BENCH STRAIGHT</b>									
MEB120	1200	625		470	10460	+1570	16	45	0,42
MEB120AVH	1200	625	670	470	11500	+1730	18	47	0,42
MEB120AV	1200	625	670	470	10980	+1650	17	46	0,42
MEB180	1800	625		470	15650	+2350	25	60	0,67
MEB180AVH	1800	625	670	470	16680	+2500	27	62	0,67
MEB180AV	1800	625	670	470	16150	+2430	26	61	0,67
MEB240	2400	625		470	18050	+2720	29	70	0,82
MEB204AVH	2400	625	670	470	19100	+2850	31	72	0,82
MEB240AV	2400	625	670	470	18580	+2790	30	71	0,82
MEB240AM	2400	625	670	470	18580	+2790	30	71	0,82
MEB240AVMH	2400	625	670	470	19630	+2960	32	73	0,82
<b>BÄNK BENCH 45 °</b>									
MEB45Y	1225/750	625		470	13970	+2100	18	50	0,42
MEB45YAVH	1225/750	625	670	470	15020	+2250	18	52	0,42
MEB45YAV	1225/750	625	670	470	14490	+2180	19	51	0,42
MEB45YAH	1225/750	625	670	470	14490	+2180	19	51	0,42
<b>BÄNK BENCH 90 °</b>									
MEB90Y	1350/475	625		470	14650	+2200	18	50	0,53
MEB90YAVH	1350/475	625	670	470	15700	+2360	20	52	0,53
MEB90YAV	1350/475	625	670	470	15170	+2270	19	51	0,53
MEB90YAH	1350/475	625	670	470	15170	+2270	19	51	0,53

Tillbehör Accessories Sofa Sofa Bänk Bench	Artno	SEK
	MEKB	<b>Kopplingsbeslag i metall placerad under sits.</b> Link fittings metal placed under the seat. 210
	MEEL	<b>1 eluttag inkl. 2 meter kabel. Placeras nära ben i framkant under sits. Gäller för SE, NO, FIN, DE, NL.</b> 1 electrical outlets incl. 2 meters cable. Placed close to legs in front under the seat. For SE, NO, FIN, DE, NL. 1840

Sofforna 3-sits och 2-sits finns med både hög och låg rygg. Soffan 1,5-sits finns endast med hög rygg medan fåtöljen finns endast med låg rygg. Gemensamt för alla modeller är att de finns i två sitthöjder; 430 och 480 mm. Rygg och gavel kommer i beige, antracit eller ljusgrå filt, alternativt kan kläs med likadant tyg som sitt- och ryggdyna (läder går dock ej att klä ryggen i). Samtliga dynor består av kallskum och kan kläs i tyg eller läder. Tjocka tyger bör undvikas. Fråga gärna innan eget tygval.

Benen är försedda med filtassar. Träslagen är massiv ek, ask, standardbetser på ask och vitpigmenterad ek eller ask. Som tillval finns sidokuddar. Pop-up bord, till 3- och 2-sits, i massivträ med lika utförande som soffa. Man kan eftermontera pop-up bord. Eluttag kan monteras i sargen framtill. Ondulé levereras monterad. Med hjälp av handverktyg är det enkelt att separera överliggaren av stommen, benen och sarg, rundstavar, rygg och klädselmaterial.  
Ange vid beställning: Artikelnummer, färg på gavel/rygg, klädsel på sittplymåer, utförande samt ev. tillbehör.

The 2-seat and 3-seat sofas come in both high-back and low-back versions. The 1.5-seat sofa is available with a high back only, while the armchair has a low back. All models offer a choice of two seating heights: 430 mm and 480 mm. The textile backs are in beige, light-grey or anthracite felt, although they may also be ordered in the same fabric as the seat and back cushions. (Please note, however, that it is not possible to choose back covers in leather.) All cushions are of cold-cured foam and can be covered in textile or leather. Thick fabrics are not recommended. Please ask before deciding on your own choice of cover.

Legs are available in a choice of solid oak or ash, standard stains on ash, or white glaze on oak or ash, all with felt floor protectors. Optional extras are side cushions and a pop-up table, for 3- and 2-seat, in solid wood to match your chosen finish on the sofa. Pop-up tables can be added at a later stage. Electrical outlets can be fitted to the front of the rail. Ondulé is supplied assembled. The appropriate hand tools are all that is required to simply disassemble the top rail of the frame, the legs, apron rail, rods, back and covers. Note when ordering: Article number, color of gable/back, fabric, finish and any accessories.

Artno

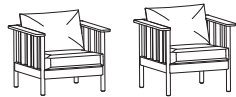

ON1004

ON1007

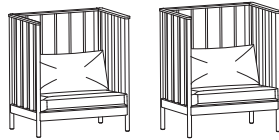

ON1554

ON1557

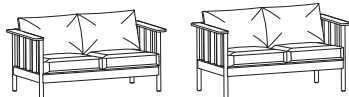

ON2004

ON2007

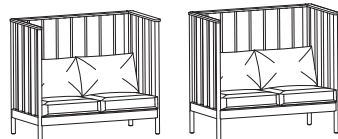

ON2054

ON2057

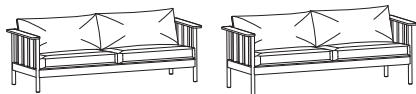



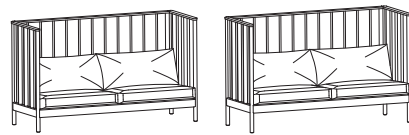

ON3004

ON3007

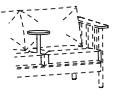

ON3054

ON3057

Tillbehör Accessories	Artno	Mått Dimension mm		SEK
	se sid 95 see page 95		<b>Gavel och rygg klädd i tyg (ej i läder).</b> Side and back upholstered in fabric (not in leather).	sid page 98
	ONSK	L620 H280	<b>Sidokudde. 2st.</b> Side cushions. 2pcs.	sid page 98
	ONPUB .10 ek oak .30 ask ash  stain on ash or white glazed on oak ash	ø260	<b>Pop-up bord. Massiv trä, klarlack. Placerad mellan sittdynor.</b> <b>Endast till ON2004, 2007, 2054, 2057, 3004, 3007, 3054, 3057</b> Pop-up table. Solid wood, clear lacquer. Placed between seats. Only for models ON2004, 2007, 2054, 2057, 3004, 3007, 3054, 3057	2190  +340 stain or glazed
	TKB11	ø57	<b>Powerdot Mini. 1 eluttag, svart, 1,5m kabel. Monteras i sargen framtill nära ben. Gäller för SE,NO,FIN,DE,NL.</b> Powerdot Mini. 1 electrical black, 1,5m cable. Electrical outlets can be fitted to the front of the rail close to leg. For SE,NO,FIN,DE,NL.	780
	TKB12	ø57	<b>Powerdot Mini. USB A laddare inkl. 2 portar, svart, 1,5m kabel. Monteras i sargen framtill nära ben. Gäller för SE,NO,FIN,DE,NL.</b> Powerdot Mini. USB A charging incl. 2 ports, black, 1,5m cable. Electrical outlets can be fitted to the front of the rail, close to leg. For SE,NO,FIN,DE,NL.	1250
	TKB13	ø35	<b>Powerdot Micro. 1xUSB A laddare, 1xUSB C laddare, svart, 1,5m kabel. Monteras i sargen framtill nära ben. Gäller för SE,NO,FIN,DE,NL.</b> Powerdot Micro. 1xUSB A charging, 1xUSB C charging, black, 1,5m cable. Electrical outlets can be fitted to the front of the rail, close to leg. For SE,NO,FIN,DE,NL.	1250

Artno	Rygg, gavel filt Back, side felt -1 light gray -2 anthracite -3 beige	Längd Length mm	Djup Depth mm	Höjd Height mm	Sithöjd Seat height mm	Ondulé SEK		Extra SEK				Standard läder Leather	Tygätgång på 140 cm bredd till sitt- och ryggplymā Requirement of fabric width 140 cm for seat and back cushion	Vikt netto Weight net kilos	Vikt brutto Weight gross kilos	Volym Volume
						.10 ek oak .30 ask ash	Standardbets på ask Standard stain on ash  Vitpigment ek ask White glazed oak ash	Tyg Fabric Prisgrupp Pricegroup 1	Tyg Fabric Prisgrupp Pricegroup 2	Tyg Fabric Prisgrupp Pricegroup 3	Tyg Fabric Prisgrupp Pricegroup 4					
ON1004	-1 light gray -2 anthracite -3 beige	865	810	790	420	23340	+2330	+2540	+3020	+3620	+4220	+5290	160 cm	28	33	1,08
ON1007	-1 light gray -2 anthracite -3 beige	865	810	860	490	23340	+2330	+2540	+3020	+3620	+4220	+5290	160 cm	30	35	1,13
ON1554	-1 light gray -2 anthracite -3 beige	1080	810	1200	420	31760	+2780	+3620	+4370	+5300	+6240	+6940	250 cm	42	50	1,48
ON1557	-1 light gray -2 anthracite -3 beige	1080	810	1270	490	31760	+2780	+3620	+4370	+5300	+6240	+6940	250 cm	44	56	1,53
ON2004	-1 light gray -2 anthracite -3 beige	1530	810	790	420	35220	+3530	+4460	+5420	+6620	+7820	+10600	320 cm	44	50	1,44
ON2007	-1 light gray -2 anthracite -3 beige	1530	810	860	490	35220	+3530	+4460	+5420	+6620	+7820	+10600	320 cm	46	55	1,51
ON2054	-1 light gray -2 anthracite -3 beige	1415	810	1200	420	40910	+4100	+4460	+5420	+6620	+7820	+10600	320 cm	54	60	2,1
ON2057	-1 light gray -2 anthracite -3 beige	1415	810	1270	490	40910	+4100	+4460	+5420	+6620	+7820	+10600	320 cm	58	64	2,16
ON3004	-1 light gray -2 anthracite -3 beige	2190	810	790	420	42480	+4250	+6620	+8120	+9990	+11870	+13890	500 cm	65	75	2,07
ON3007	-1 light gray -2 anthracite -3 beige	2190	810	860	490	42480	+4250	+6620	+8120	+9990	+11870	+13890	500 cm	70	80	2,17
ON3054	-1 light gray -2 anthracite -3 beige	2080	810	1200	420	49440	+4940	+6620	+8120	+9990	+11870	+13890	500 cm	75	85	2,8
ON3057	-1 light gray -2 anthracite -3 beige	2080	810	1270	490	49440	+4940	+6620	+8120	+9990	+11870	+13890	500 cm	80	90	2,9

Artno	Ondulé SEK	Tyg Fabric Prisgrupp Pricegroup 1	Tyg Fabric Prisgrupp Pricegroup 2	Tyg Fabric Prisgrupp Pricegroup 3	Tyg Fabric Prisgrupp Pricegroup 4	Standard läder Leather	Tygätgång 140cm bredd till gavel och rygg Requirement of fabric width 140 cm for gavel and back	Tygätgång 140cm bredd till sidokudde Requirement of fabric width 140 cm for side pillow
<b>Tillbehör Accessories</b>								
Klädsel gavel och bakrygg till Upholstery side and back for								
ON1004-9, ON1007-9	1140	+3020	+3620	+4370	+5120	--	200 cm	
ON1554-9, ON1557-9	1250	+8300	+10220	+12620	+15020	--	640 cm	
ON2004-9, ON2007-9	1460	+3020	+3620	+4370	+5120	--	200 cm	
ON2054-9, ON2057-9	1460	+9140	+11270	+13930	+16590	--	710 cm	
ON3004-9, ON3007-9	1740	+3380	+4070	+4930	+5790	--	230 cm	
ON3054-9, ON3057-9	1740	+10820	+13370	+16550	+19740	--	850 cm	
ONSK 2pcs Sidokudde Side cushions	3550	+1460	+1670	+1930	+2180	+2230		70 cm



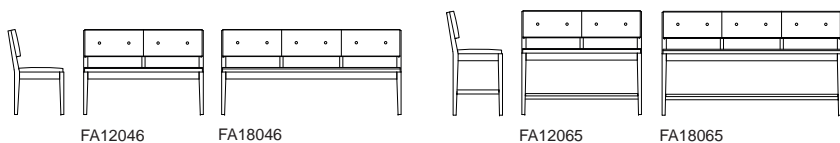

**Soffa.**  
 Stoppning kallsaum. Klädd rygg med klädda knappar och klädd sits, exkl tyg/läder.  
 Stoppning kallsaum.  
 Ben i massiv trä. Ytbehandling klarlack. Soffan levereras monterad.  
 Vid beställning ange artikelnummer, utförande och klädsel.

**Sofa.**  
 Padding polyether. Upholstered back incl. bottom and and upholstered seat excl. fabric/leather.  
 Legs in solid wood. Finish clear lacquer. The sofa comes pre-assembled.  
 When ordering article number, execution and name of fabric/leather.

Artno

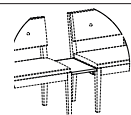
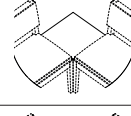
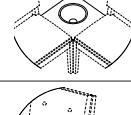

Soffa Sofa FA12065 Pop-up bord table FAPUB | Hylla Shelf CUBE BRICK | Pall Stool SHELL | Bord Table LOLLIPOP

Tillbehör Accessories	Artno	Mått Dimension mm	
	FAASV	B/W 41	<b>Armstöd. Vänsterställd. Massiv trä, klarlack.</b> Armrest. Left hung. Solid wood.
	FAASH	B/W 41	<b>Armstöd. Högerställd. Massiv trä, klarlack.</b> Armrest. Right hung. Solid wood, clear lacquer
	FAPUB	ø290	<b>Pop-up bord inkl. 1st krok. Massiv trä, klarlack. Placerad enligt önskemål. Beslag blankkrom.</b> Pop-up table incl. 1pc hook. Solid wood, clear lacquer. Placed upon request. Fitting polished chrome
	FAKB1	L275 B/W450	<b>Kopplingsbord, rak. Fanerad trälamell, klarlack.</b> Linking table, straight. Veneered blockboard, clear lacquer.
	FAKB2	450x450	<b>Kopplingsbord hörn. Fanerad trälamell, klarlack.</b> Linking table, corner. Veneered blockboard, clear lacquer.
	FAKB2S	450x450 skål bowl ø250	<b>Kopplingsbord hörn. Fanerad trälamell, klarlack. Inkl. planteringskär! svart ABS plast.</b> Linking table, corner. Veneered blockboard, clear lacquer. Incl. planting bowl black ABS plastic.
	FAKBS		<b>Kopplingsbeslag mellan soffor. Svart metall.</b> Link fittings between sofas. Black metal.

Artno	Längd Length mm	Djup Depth mm	Höjd Height mm	Sitthöjd Seat height mm	Facile SEK	Extra SEK					Tygåtgång på 140 cm bredd Requirement of fabric width 140 cm	Vikt netto Weight net kilos	Vikt brutto Weight gross kilos	Volym Volume	
					.10 ek oak .30 ask ash	Standardbets på ask Standard stain on ash  Vitpigment ek ask White glazed oak ash	Tyg Fabric Prisgrupp Pricegroup 1	Tyg Fabric Prisgrupp Pricegroup 2	Tyg Fabric Prisgrupp Pricegroup 3	Tyg Fabric Prisgrupp Pricegroup 4					Standard läder Leather
FA12046	1200	560	852	460	19640	+2960	+2300	+2720	+3240	+3770	+5450	140 cm	22	60	1,06
FA18046	1800	560	852	460	23740	+3560	+3020	+3620	+4370	+5120	+7460	200 cm	31	80	1,68
FA12065	1200	560	1042	650	22000	+3300	+2300	+2720	+3240	+3770	+5450	140 cm	28	70	1,26
FA18065	1800	560	1042	650	26470	+3960	+3020	+3620	+4370	+5120	+7460	200 cm	36	90	2,0

Artno	Längd Length mm	Bredd Width mm	Diam mm	Tillbehör Accessories SEK	Extra SEK	Vikt brutto Weight gross kilos
				.10 ek oak .30 ask ash	Standardbets på ask Standard stain on ash  Vitpigment ek ask White glazed oak ash	
FAASV Armstöd vänster Armrest left		41		1010	+160	0,5
FAASH Armstöd höger Armrest right		41		1010	+160	0,5
FAPUB Pop-up bord table			290	2490	+380	2
FAKB1 Koppl.bord rak Linking table straight	275	450		2070	+320	3
FAKB2 Koppl.bord hörn Linking table corner	450	450		3250	+490	8
FAKB2S Koppl.bord hörn inkl. planteringskäril Linking table corner incl. planting bowl	450	450	250 skål bowl	3930	+490	9
FAKBS Koppl.beslag, svart Link fittings, black				390 svart black metal		

# KAMÓN DINNER

Moni Beuchel 2017



## Soffa.

Klädd rygg och sits exkl. tyg/läder. Stoppning kallskum.  
Ben i massiv trä. Ytbehandling klarlack. Soffan levereras monterad.  
Vid beställning ange artikelnummer, utförande och klädsel.

## Sofa.

Upholstered back and seat excl. fabric/leather. Padding in cold-cured foam.  
Legs in solid wood. Finish clear lacquer. The sofa comes pre-assembled.  
When ordering article number, execution and name of fabric/leather.

Artno

Rak soffa / Straight sofa



382

383

384

Innerhörn / Inner corner

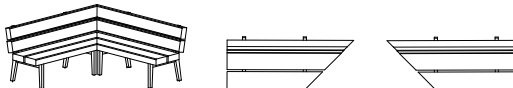

Höger / Right  
382IH  
383IH  
384IH

Vänster / Left  
382IV  
383IV  
384IV

Ytterhörn / Outer corner



Höger / Right  
382YH  
383YH  
384YH

Vänster / Left  
382YV  
383YV  
384YV



Tillbehör Accessories	Artno	Mått Dimension mm	
	381AS1.3		<b>Armstöd klädd. Placerad enligt önskemål, ej över ben. Beslag svart metall.</b> Armrest upholstered. Placed upon request, not over leg. Fitting black metal.
	381AS2.3		<b>Armstöd klädd. Placerad över ben. Beslag svart metall.</b> Armrest upholstered. Placed over leg. Fitting black metal.
	381PB1	L494 ø280 H655 från golv from floor	<b>Pop-up bord. Massiv trä, klarlack. Placerad enligt önskemål, ej över ben. Beslag svart metall.</b> Pop-up table. Solid wood, clear lacquer. Placed upon request, not over leg. Fitting black metal.
	381PB2	L494 ø280 H655 från golv from floor	<b>Pop-up bord. Massiv trä, klarlack. Placerad över ben. Beslag svart metall.</b> Pop-up table. Solid wood, clear lacquer. Placed over leg. Fitting black metal.
	381KB1	450x450	<b>Kopplingsbord rak.</b> Linking table, straight.
	381KB2	450x450	<b>Kopplingsbord hörn.</b> Linking table, corner.
	381.EL.1		<b>1 eluttag inkl. 2meter kabel. Placeras nära benen i framkant under sits.</b> 1 electrical outlets incl. 2meters cable. Placed close to legs in front under seat.
	381.KB		<b>Kopplingsbeslag. Svart metall.</b> Link fittings. Black metal.



Kamón Dinner SEK							Extra SEK								
Artno	Längd Length mm	Djup Depth mm	Höjd Height mm	Sitthöjd Seat height mm	.10 ek oak .20 björk birch .30 ask ash	.50 Lack Color	Standardbets på ask Standard stain on ash Vitpigment ek ask White glazed oak ash	Tyg Fabric Prisgrupp Pricegroup 1	Tyg Fabric Prisgrupp Pricegroup 2	Tyg Fabric Prisgrupp Pricegroup 3	Tyg Fabric Prisgrupp Pricegroup 4	Standard läder Leather	Tygåtgång på 140 cm bredd Requirement of fabric width 140 cm	Vikt brutto Weight gross kilos	Volym Volume
<b>Soffa rak Sofa straight</b>															
382	1300	656	818	460	17410	19990	+2610	+4460	+5420	+6620	+7820	+7270	320 cm	32	0,8
383	1950	656	818	460	23210	26670	+3500	+6020	+7370	+9050	+10740	+10620	450 cm	47	1,2
384	2600	656	818	460	28050	32250	+4190	+7580	+9320	+11490	+13670	+14160	580 cm	56	1,6
<b>Hörn Corner</b>															
382IH	1300	656	818	460	22450	25050	+2610	+4460	+5420	+6620	+7820	+7270	320 cm	32	0,8
382IV	1300	656	818	460	22450	25050	+2610	+4460	+5420	+6620	+7820	+7270	320 cm	32	0,8
382YH	1300	656	818	460	22900	25490	+2610	+4460	+5420	+6620	+7820	+7270	320 cm	32	0,8
382YV	1300	656	818	460	22900	25490	+2610	+4460	+5420	+6620	+7820	+7270	320 cm	32	0,8
383IH	1950	656	818	460	28270	31750	+3500	+6020	+7370	+9050	+10740	+10620	450 cm	47	1,2
383IV	1950	656	818	460	28270	31750	+3500	+6020	+7370	+9050	+10740	+10620	450 cm	47	1,2
383YH	1950	656	818	460	28720	32190	+3500	+6020	+7370	+9050	+10740	+10620	450 cm	47	1,2
383YV	1950	656	818	460	28720	32190	+3500	+6020	+7370	+9050	+10740	+10620	450 cm	47	1,2
384IH	2600	656	818	460	33130	37310	+4190	+7580	+9320	+11490	+13670	+14160	580 cm	56	1,6
384IV	2600	656	818	460	33130	37310	+4190	+7580	+9320	+11490	+13670	+14160	580 cm	56	1,6
384YH	2600	656	818	460	33560	37760	+4190	+7580	+9320	+11490	+13670	+14160	580 cm	56	1,6
384YV	2600	656	818	460	33560	37760	+4190	+7580	+9320	+11490	+13670	+14160	580 cm	56	1,6

Tillbehör Accessories SEK							Extra SEK								
Artno	Längd Length mm	Bredd Width mm	Diam mm	Höjd Height mm	Klädd exkl tyg/läder Upholstred excl fabric/leather	.10 ek oak .20 björk birch .30 ask ash	.50 Lack Color	Standardbets på ask Standard stain on ash Vitpigment ek ask White glazed oak ash	Tyg Fabric Prisgrupp Pricegroup 1	Tyg Fabric Prisgrupp Pricegroup 2	Tyg Fabric Prisgrupp Pricegroup 3	Tyg Fabric Prisgrupp Pricegroup 4	Standard läder Leather	Tygåtgång på 140 cm bredd Requirement of fabric width 140 cm	Vikt brutto Weight gross kilos
381AS1.3 Armstöd Armrest					2720				+1220	+1370	+1550	+1740	+1130	45 cm	1
381AS2.3 Armstöd Armrest					2720				+1220	+1370	+1550	+1740	+1130	45 cm	1
381PB1 Pop-up bord table	494		280	655 från golv from floor		3760	4340	+570							2
381PB2 Pop-up bord table	494		280	655 från golv from floor		3760	4340	+570							2
381KB1 Koppl.bord rak Linking table straight	450	450				3420	3940	+510							3
381KB2 Koppl.bord hörn Linking table corner	450	450				4800	5530	+730							8
381EL1 Eluttag Electrical outlet						1950	1950	+150							1
381.KB Koppl.beslag svart Link fittings black							340 svart black								1

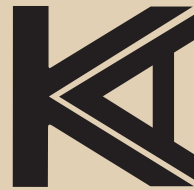

KARL ANDERSSON & SÖNER

**Handmade in Huskvarna. Since 1898.**

**Karl Andersson & Söner** Rosendalagatan 6, SE-561 34 Huskvarna, Sweden.  
+46(0)36-13 25 30. [info@karl-andersson.se](mailto:info@karl-andersson.se)

**Showrooms**

**Studio B3.** Barnhusgatan 3. Stockholm. +46 (0)8 21 42 31  
**Studio L6.** Lasarettsgatan 6. Göteborg. +46 (0)31 13 83 90

[karl-andersson.se](http://karl-andersson.se)

SENAB

**22%** RABATT SKA DRAS AV PÅ ANGIVNA PRISER