

# Sitland

2024

STATLIGT RAMAVTAL FÖR

## *Möbler och inredning*

Delområde: Möte och paus

DNR 23.3-5834-2022-009

Produktlista Nr: 1

**22%** RABATT SKA DRAS AV  
PÅ ANGIVNA PRISER



**SENAB**

*Developing interiors*

# Vi hjälper dig att hitta rätt

Med olika utseende på prislistor från olika möbeltillverkare förstår vi att det kan vara tidskrävande att navigera i denna information. Vi på Senab är jobbar dagligen i dessa, så låt oss göra sökandet enkelt och bekvämt för dig, och hjälpa dig till rätt beslut. Här hittar du din kontaktperson på våra respektive kontor.

## STOCKHOLM

Peter Almgren  
076-533 50 43  
peter.almgren@senab.com  
Regeringsgatan 66  
111 39 Stockholm

## HÄLSINGLAND

Frida Engberg  
076-501 10 91  
frida.engberg@senab.com  
Karlsvägen 2  
828 25 Edsbyn

## SUNDSVALL

Jonas Westerlund  
076-502 02 04  
jonas.westerlund@senab.com  
Storgatan 4  
852 30 Sundsvall

## GÖTEBORG

Henrik Ericsson  
073-044 10 91  
henrik.ericsson@senab.com  
Fiskhamngatan 6C  
414 58 Göteborg

## GÄVLE/DALARNA

Cecilia Sjöblom  
076-501 10 93  
cecilia.sjoblom@senab.com  
Nygatan 28  
803 11 Gävle

## UMEÅ

Patrik Karlsson  
070-654 0066  
patrik.karlsson@senab.com  
Storgatan 41  
903 25 Umeå

## MALMÖ

Magdalena Andersson  
076-535 75 87  
magdalena.andersson@senab.com  
Fersens väg 3  
211 42 Malmö

## JÖNKÖPING

Pia Heldt  
076-533 51 57  
pia.heldt@senab.com  
Västra Storgatan 19A  
553 15 Jönköping

## UPPSALA

Linnéa Hempel  
076-195 39 86  
linnea.hempel@senab.com  
Stationsgatan 32 C  
753 40 Uppsala

**22%** RABATT SKA DRAS AV  
PÅ ANGIVNA PRISER

**SENAB**  
*Developing interiors*

# Classic

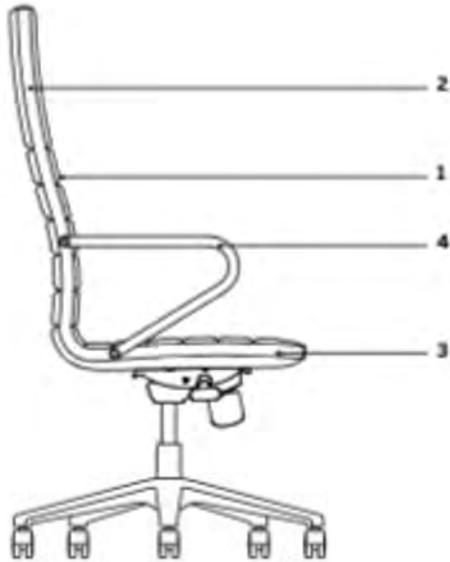

## TEKNISK SPECIFIKATION

- 1 Sits och rygg, PU (skum)
- 2 Inre struktur i stål
- 3 Ram struktur i stål, "kromfinish"
- 4 Fast karm



# Classic Meeting

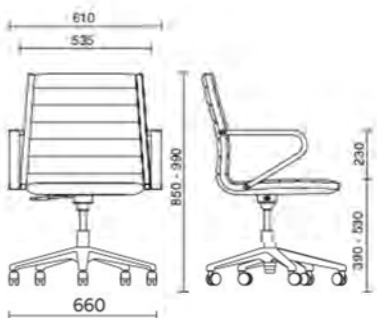
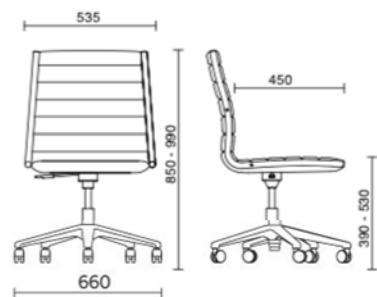

## Grundutförande:

Låg rygg  
 Ram, krom eller svart – val nedan  
 Sits/rygg i PU, CFC-fri  
 5 fotkryss polerad aluminium eller svart (rakt) – val nedan  
 Hjul ø 65 mm – val av hjul, ändra position 9 i artikel.nr

## Höjdjustering

## Tillval:

Fast karm (oklädd)  
 Fast karm, med klädd "top", tyg eller skinn - val nedan, ändra position 7 i artikel.nr  
 Hjul ø 65 mm, ihåliga – val nedan, ändra position 9 i artikel.nr  
 3D "soft-tilt" - val nedan, ändra position 6 i artikel.nr

Volym: 0,313 m3  
 Netto vikt: 11,00 kg  
 Gross vikt: 14,00 kg  
 Förpackade: 1 krt  
 COM, tygätgång 1,40 m – Tygbredd: 1,4 m

1	2	3	4	5	6	7	8	9	10	Pg.1	Pg.2	Pg.3	Pg.4	Pg.5	Pg.9	Pg.A	Pg.E	Pg.C
C	S	M	A	0	2	0	-	-	1	NX	ME	CH	MF-SC-COM	CS-SY	RM	SX+NX	PA	TS
Grundutförande - välj hjul nr. 7, 8 eller 9										6 900 kr	7 200 kr	7 605 kr	7 905 kr	9 120 kr	9 330 kr	8 430 kr	9 165 kr	11 925 kr

-	-	-	-	-	-	-	-	-	-	D	-	-	Krom ram och alu. Fotkryss						0
-	-	-	-	-	-	-	-	-	-	E	-	-	Svart ram och fotkryss						0

-	-	-	-	-	-	-	-	-	-	6	-	-	glidfötter ø 65 mm, obromsat, för matta						0
-	-	-	-	-	-	-	-	-	-	7	-	-	ø 65 mm, bromsat, för matta						0
-	-	-	-	-	-	-	-	-	-	8	-	-	ø 65 mm, bromsat, för hårt golv						0
-	-	-	-	-	-	-	-	-	-	9	-	-	ø 65 mm, ihåligt, svart						0
-	-	-	-	-	-	-	-	-	-	N	-	-	ø 65 mm, ihåligt, krom						tillägg 480 kr
-	-	-	-	-	-	-	-	-	-	C	-	-							tillägg 555 kr

-	-	-	-	-	-	-	-	-	-	1	-	-	Karm / Armstöd (oklädd)						tillägg 1 875 kr
---	---	---	---	---	---	---	---	---	---	---	---	---	-------------------------	--	--	--	--	--	------------------

1	2	3	4	5	6	7	8	9	10	Pg.1	Pg.2	Pg.3	Pg.4	Pg.5	Pg.9	Pg.A	Pg.E	Pg.C	
-	-	-	-	-	-	-	-	-	-	3	-	-	Klädd karm i samma tyg som stolen						tillägg 2 355 kr
-	-	-	-	-	-	-	-	-	-	5	-	-	Klädd karm i "SX" läder, valfri färg						tillägg 3 240 kr

-	-	-	-	-	-	-	-	-	-	C	-	-	3D "soft-tilt"						tillägg 1 830 kr
---	---	---	---	---	---	---	---	---	---	---	---	---	----------------	--	--	--	--	--	------------------





# Classic Visitor

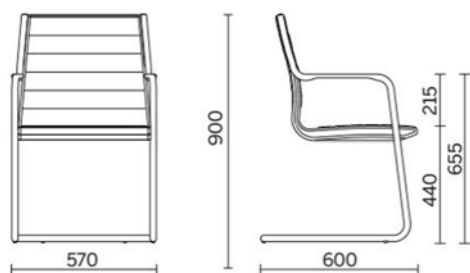

## Grundutförande:

Låg rygg  
Medstativ, krom eller svart – val nedan (*position 8*)  
Sits/rygg i PU, CFC-fri

Volym: 0,379 m<sup>3</sup>  
Netto vikt: 11,00 kg  
Gross vikt: 13,80 kg  
Förpackade: 1 krt  
COM, tygätgång 1,30 m – Tygbredd: 1,4 m

1 2 3 4 5 6 7 8 9 10

J L V A 0 1 0 D 0 0

**Classic - visitor, medstativ, krom**

J L V A 0 1 0 E 0 0

**Classic - visitor, medstativ, svart**

Pg.1	Pg.2	Pg.3	Pg.4	Pg.5	Pg.9	Pg.A	Pg.E	Pg.C
NX	ME	CH	MF-SC-COM	CS-SY	RM	SX+NX	PA	TS
6 510 kr	6 825 kr	7 170 kr	7 590 kr	8 820 kr	9 030 kr	8 145 kr	9 270 kr	11 940 kr
6 510 kr	6 825 kr	7 170 kr	7 590 kr	8 820 kr	9 030 kr	8 145 kr	9 270 kr	11 940 kr



# Soul Air



## TEKNISK SPECIFIKATION

- 1 Struktur i PA, med alternativt utan karm
- 2 2D "soft-tilt" i polerad aluminium, integrerat i strukturen
- 3 Sits/Rygg i mesh
- 4 PP i framkant av sitsen och i toppen av ryggen
- 5 Förstärkt sits



# Soul Air

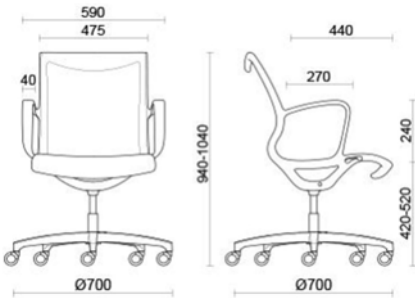
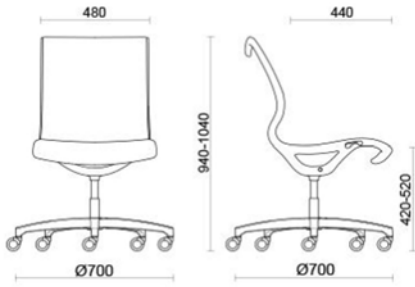

## Grundutförande:

Sits/Rygg i mesh  
 Struktur i PA/PP, med alternativt utan karm  
 5-fotkryss  $\varnothing$  700 mm, stålförstärkt PA  
 Hjul  $\varnothing$  65 mm – val av hjul, ändra position 9 i artikel.nr

Höjdjustering  
 2D "soft-tilt"

## Tillval:

Hjul  $\varnothing$  65 mm, ihåliga – val nedan, ändra position 9 i artikel.nr  
 5-fotkryss  $\varnothing$  700 mm, polerad aluminium – val nedan, ändra position 8 i artikel.nr  
 Version i ljusgrått – val nedan, ändra position 5 och 8 i artikel.nr

Volym: 0,309 m<sup>3</sup>  
 Netto vikt: 9,00 kg  
 Gross vikt: 12,00 kg  
 Förpackade: 1 krt

1	2	3	4	5	6	7	8	9	10		RR	RY	IR
S	U	N	1	A	A	1	1	-	0	Utan karm	8 100 kr	8 355 kr	8 400 kr
Grundutförande - välj hjul nr. 7, 8 eller 9													
S	U	M	1	A	A	1	1	-	0	Med karm	8 175 kr	8 415 kr	8 475 kr
Grundutförande - välj hjul nr. 7, 8 eller 9													

1	2	3	4	5	6	7	8	9	10				
-	-	-	-	-	-	-	-	7	-	$\varnothing$ 65 mm, obromsat, för matta			0
-	-	-	-	-	-	-	-	8	-	$\varnothing$ 65 mm, bromsat, för matta			0
-	-	-	-	-	-	-	-	9	-	$\varnothing$ 65 mm, bromsat, för hårt golv			0
-	-	-	-	-	-	-	-	N	-	$\varnothing$ 65 mm, ihåligt, svart	tillägg		420 kr
-	-	-	-	-	-	-	-	C	-	$\varnothing$ 65 mm, ihåligt, krom	tillägg		465 kr

1	2	3	4	5	6	7	8	9	10				
-	-	-	-	-	-	-	3	-	-	5-fotkryss $\varnothing$ 700 mm, polerad alu	tillägg		735 kr
-	-	-	-	B	-	-	2	-	-	Version i ljusgrått, 5-fotkryss i stålförstärkt nylon, gäller endast stol med karm	tillägg		630 kr
-	-	-	-	B	-	-	3	-	-	Version i ljusgrått, 5-fotkryss i polerad alu, gäller endast stol med karm	tillägg		1365 kr
-	-	-	-	-	-	-	7	D	-	pyramid 5-fotkryss $\varnothing$ 700 mm, svart aluminium med $\varnothing$ 65 mm svarta hjul, ihåliga	tillägg		2025 kr
-	-	-	-	-	-	-	6	E	-	pyramid 5-fotkryss $\varnothing$ 700 mm, polerad aluminium med $\varnothing$ 65 mm svarta hjul, ihåliga	tillägg		2280 kr

För versin med 4-kryss platt eller pyramid, be om offert

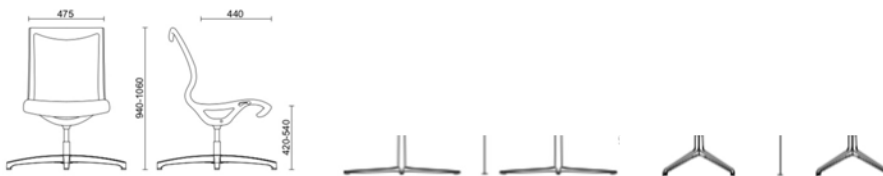

SENAB

22% RABATT SKA DRAS AV PÅ ANGIVNA PRISER



# Soul Tecno

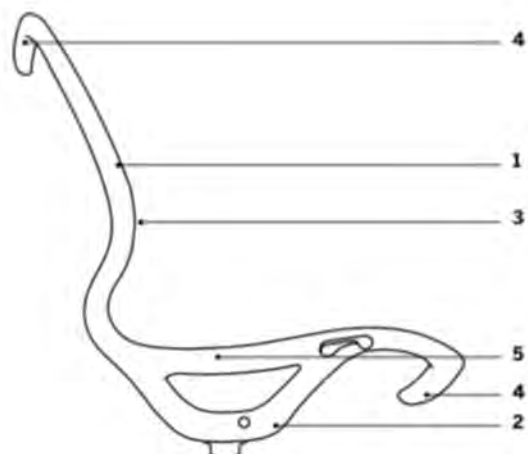

## TEKNISK SPECIFIKATION

- 1 Struktur i PA, med alternativt utan karm
- 2 2D "soft-tilt" i polerad aluminium, integrerat i strukturen
- 3 Sits/Rygg i tygmembran, horisontell design
- 4 PP i framkant av sitsen och i toppen av ryggen
- 5 Förstärkt sits

Tyg - Tecno	Färger
<b>ME</b>	ME01 - ME02 - ME03 - ME09



# Soul Tecno

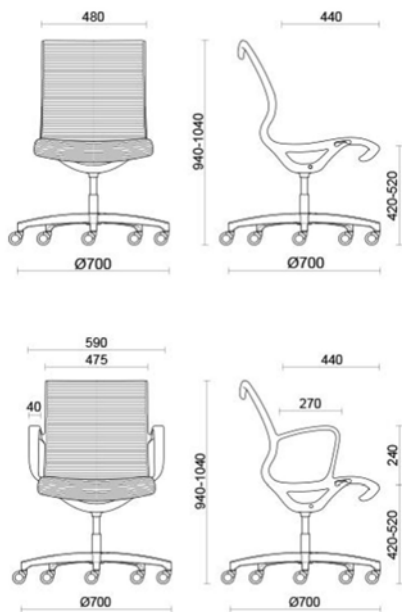

## Grundutförande:

Sits/Rygg i tyg membran  
 Struktur i PA/PP, med alternativt utan karm  
 5-fotkryss  $\varnothing$  700 mm, stålförstärkt PA  
 Hjul  $\varnothing$  65 mm – val av hjul, ändra position 9 i artikel.nr

Höjdjustering  
 2D "soft-tilt"

## Tillval:

Hjul  $\varnothing$  65 mm, ihåliga – val nedan, ändra position 9 i artikel.nr  
 5-fotkryss  $\varnothing$  700 mm, polerad aluminium – val nedan, ändra position 8 i artikel.nr  
 Version i ljusgrått – val nedan, ändra position 5 och 8 i artikel.nr

Volym: 0,309 m<sup>3</sup>  
 Netto vikt: 9,00 kg  
 Gross vikt: 12,00 kg  
 Förpackade: 1 krt

1 2 3 4 5 6 7 8 9 10

Utan karm

S U N 2 A A 1 1 - 0

Grundutförande - välj hjul nr. 7, 8 eller 9

TECNO  
 ME-01,02,  
 03,09

9 765 kr

1 2 3 4 5 6 7 8 9 10

Med karm

S U M 2 A A 1 1 - 0

Grundutförande - välj hjul nr. 7, 8 eller 9

ME-01,02,  
 03,09

10 095 kr

1 2 3 4 5 6 7 8 9 10

- - - - - - - 7 -  $\varnothing$  65 mm, obromsat, för matta  
 - - - - - - - 8 -  $\varnothing$  65 mm, bromsat, för matta  
 - - - - - - - 9 -  $\varnothing$  65 mm, bromsat, för hårt golv  
 - - - - - - - N -  $\varnothing$  65 mm, ihåligt, svart  
 - - - - - - - C -  $\varnothing$  65 mm, ihåligt, krom

tillägg 420 kr

tillägg 465 kr

1 2 3 4 5 6 7 8 9 10

- - - - - - - 3 - 5-fotkryss  $\varnothing$  700 mm, polerad alu  
 - - - - B - - 2 - Version i ljusgrått, 5-fotkryss i stålförstärkt nylon, gäller endast stol med karm  
 - - - - B - - 3 - Version i ljusgrått, 5-fotkryss i polerad alu, gäller endast stol med karm

tillägg 735 kr

tillägg 630 kr

tillägg 1 365 kr

För versin med platt 4-kryss, be om offert

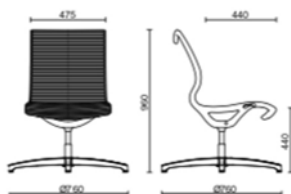

SENAB

22% RABATT SKA DRAS AV PÅ ANGIVNA PRISER



# Milos Life

design Dorigo



## TEKNISK SPECIFIKATION

- 1 Inre struktur i PU med stålram – monoblock

## KLÄDD I ETT TYG - TVÅ FÄRGER

Denna produkt kan göras i tvåfärgad klädsel.  
Pristillägg +10%. Minst beställning 2 stolar.

Art.nr. sammansättning:

Art.nr. kod										Tyg/Färg framsid				Tyg/Färg baksid			
1	2	3	4	5	6	7	8	9	10	11	12	13	14	15	16	17	18
M	I																



# Milos Life

pyramid stativ

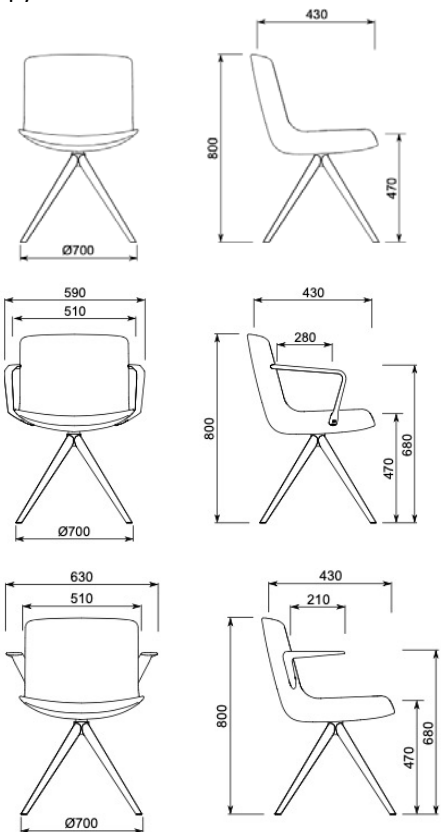

## Grundutförande:

Helklädd, stoppad stol  
Pyramidben trä – val nedan, ändra position 8 i artikel.nr

Snurrbar

## Tillval:

Karm – val nedan, ändra position 6 i artikel.nr  
Klädd i samma tyg med två färger, fram-baksida + 10% (minimiorder 2 st)

Volym: 0,35 m3  
Netto vikt: 11,40 / 10,30 kg  
Gross vikt: 13,80 / 12,70 kg  
Förpackade: 1 krt  
COM, tygätgång 1,20 m – Tygbredd: 1,4 m

1 2 3 4 5 6 7 8 9 10

M I A A 2 0 F - 6 1

Grundutförande -  
val färg stativ 5 eller 6

Pg.1	Pg.2	Pg.3	Pg.4	Pg.5	Pg.9	Pg.10	Pg.11	Pg.A
AL	ME	CH	SC-RG-MF- MW-COM	CS-SY-YO- WI-FT	RM	RW-HE	FD-S1-SE- S4	SX+NX
9 300 kr	9 645 kr	9 675 kr	10 005 kr	10 665 kr	10 980 kr	11 700 kr	12 375 kr	10 740 kr

1 2 3 4 5 6 7 8 9 10

- - - - - 5 - -  
- - - - - 6 - -

Benstativ - Trä bok natur  
Benstativ - Trä bok wengéfärg

0  
0

1 2 3 4 5 6 7 8 9 10

- - - - - L - - - -  
- - - - - M - - - -  
- - - - - I - - - -  
  
- - - - - D - - - -  
- - - - - E - - - -  
- - - - - C - - - -

"Loop" karm - vit  
"Loop" karm - svart  
"Loop" karm - krom  
  
"Öppen" karm - vit  
"Öppen" karm - svart  
"Öppen" karm - krom



Volym: + 0,026 m2  
Netto vikt: + 1,00 kg  
Gross vikt: + 1,00 kg

tillägg 1710  
tillägg 1710  
tillägg 2265

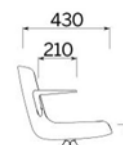

Volym: + 0,026 m2  
Netto vikt: + 2,00 kg  
Gross vikt: + 2,00 kg

tillägg 2640  
tillägg 2640  
tillägg 3210



# Milos Life

5 kryss stativ

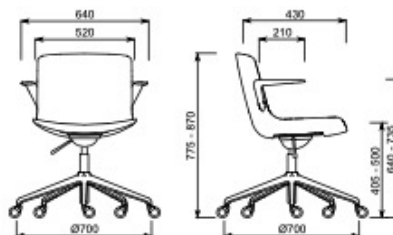
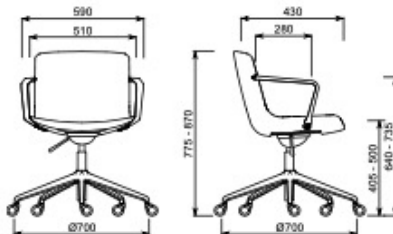
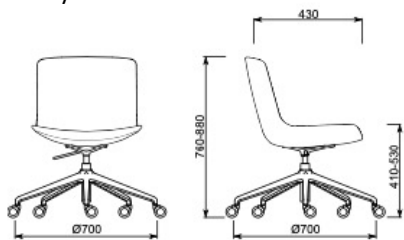

1 2 3 4 5 6 7 8 9 10

M I A A 4 0 C - - 1

Grundutförande -  
val färg stativ 1, 2 eller 4  
val hjul 7,8 eller 9

## Grundutförande:

Helklädd, stoppad stol  
5 fotkryss – val nedan, ändra position 8 i artikel.nr  
Hjul  $\varnothing$  65 mm – val av hjul, ändra position 9 i artikel.nr

Snurrbar  
Höjdjustering

## Tillval:

2D "soft-tilt" – val nedan, ändra position 5 i artikel.nr  
Karm – val nedan, ändra position 6 i artikel.nr  
Klädd i samma tyg med två färger, fram-baksida + 10% (minimiorder 2 st)

Volym: 0,390 m3  
Netto vikt: 11,10 kg  
Gross vikt: 14,35 kg  
Förpackade: 1 krt  
COM, tygätgång 1,20 m – Tygbredd: 1,4 m

Pg.1	Pg.2	Pg.3	Pg.4	Pg.5	Pg.9	Pg.10	Pg.11	Pg.A
AL	ME	CH	SC-RG-MF- MW-COM	CS-SY-YO- WI-FT	RM	RW-HE	FD-S1-SE- S4	SX+NX
8 550 kr	8 760 kr	8 790 kr	9 105 kr	9 750 kr	10 320 kr	10 845 kr	11 505 kr	9 825 kr

1 2 3 4 5 6 7 8 9 10

- - - - 7 - - - -

2D soft-tilt

0

1 2 3 4 5 6 7 8 9 10

- - - - - 1 - -

5 fotkryss, vit

0

- - - - - 2 - -

5 fotkryss, svart

0

- - - - - 4 - -

5 fotkryss, polerad aluminium

tillägg

2430

1 2 3 4 5 6 7 8 9 10

- - - - - 7 - -

$\varnothing$  65 mm, obromsat, för matta

0

- - - - - 8 - -

$\varnothing$  65 mm, bromsat, för matta

0

- - - - - 9 - -

$\varnothing$  65 mm, bromsat, för hårt golv

0

- - - - - F - -

$\varnothing$  65 mm, ihåligt, vit

tillägg

405 kr

- - - - - D - -

$\varnothing$  65 mm, ihåligt, svart

tillägg

495 kr

- - - - - E - -

$\varnothing$  65 mm, ihåligt, krom

tillägg

555 kr

1 2 3 4 5 6 7 8 9 10

- - - - - L - - - -

"Loop" karm - vit

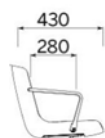

Volym: + 0,026 m2  
Netto vikt: + 1,00 kg  
Gross vikt: + 1,00 kg

tillägg

1710

- - - - - M - - - -

"Loop" karm - svart

tillägg

1710

- - - - - I - - - -

"Loop" karm - krom

tillägg

2265

- - - - - D - - - -

"Öppen" karm - vit

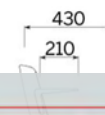

Volym: + 0,026 m2  
Netto vikt: + 2,00 kg  
Gross vikt: + 2,00 kg

tillägg

2640

- - - - - E - - - -

"Öppen" karm - svart

tillägg

2640

- - - - - - - - - -

"Öppen" karm - krom

tillägg

2640

SENAB

**22% RABATT SKA DRAS AV PÅ ANGIVNA PRISER**



# Milos Life

4 kryss stativ

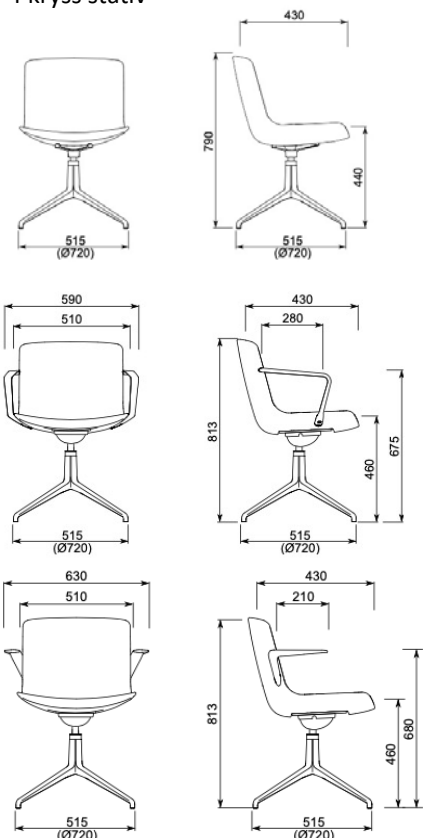

## Grundutförande:

Helklädd, stoppad stol  
4 fotkryss – val färg nedan, ändra position 8 i artikel.nr  
Glidfötter

Snurrbar

## Tillval:

2D "soft-tilt" – val nedan, ändra position 5 i artikel.nr  
Karm – val nedan, ändra position 6 i artikel.nr  
Klädd i samma tyg med två färger, fram-baksida + 10% (minimiorder 2 st)

Volym: 0,350 m3  
Netto vikt: 11,10 kg  
Gross vikt: 14,35 kg  
Förpackade: 1 krt  
COM, tygätgång 1,20 m – Tygbredd: 1,4 m

	Pg.1	Pg.2	Pg.3	Pg.4	Pg.5	Pg.9	Pg.10	Pg.11	Pg.A
1	AL	ME	CH	SC-RG-MF-MW-COM	CS-SY-YO-WI-FT	RM	RW-HE	FD-S1-SE-S4	SX+NX
M I A A 5 0 E - 6 1	9 465 kr	9 675 kr	9 705 kr	10 035 kr	10 680 kr	11 265 kr	11 925 kr	12 600 kr	10 770 kr

Grundutförande -  
val färg stativ 1, 2 eller 4

1	2	3	4	5	6	7	8	9	10		
-	-	-	-	8	-	-	-	-	-	2D soft-tilt	0
-	-	-	-	-	-	-	1	-	-	5 fotkryss, vit	0
-	-	-	-	-	-	-	2	-	-	5 fotkryss, svart	0
-	-	-	-	-	-	-	4	-	-	5 fotkryss, polerad aluminium	tillägg 945

1	2	3	4	5	6	7	8	9	10		
-	-	-	-	-	L	-	-	-	-	"Loop" karm - vit	tillägg 1710
-	-	-	-	-	M	-	-	-	-	"Loop" karm - svart	tillägg 1710
-	-	-	-	-	I	-	-	-	-	"Loop" karm - krom	tillägg 2265
-	-	-	-	-	D	-	-	-	-	"Öppen" karm - vit	tillägg 2640
-	-	-	-	-	E	-	-	-	-	"Öppen" karm - svart	tillägg 2640
-	-	-	-	-	C	-	-	-	-	"Öppen" karm - krom	tillägg 3210



Volym: + 0,026 m2  
Netto vikt: + 1,00 kg  
Gross vikt: + 1,00 kg

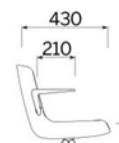

Volym: + 0,026 m2  
Netto vikt: + 2,00 kg  
Gross vikt: + 2,00 kg

SENAB

22% RABATT SKA DRAS AV PÅ ANGIVNA PRISER



# Milos Elle

design Dorigo

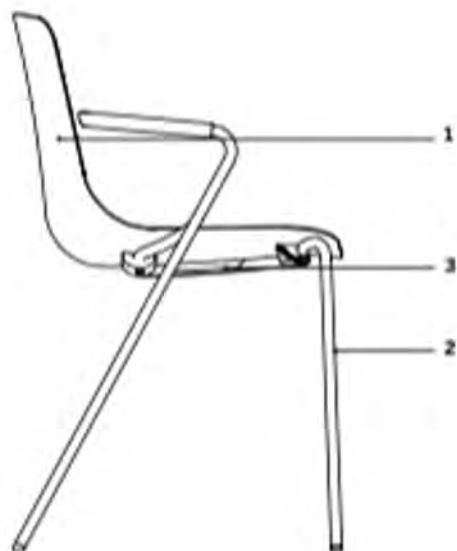

## TEKNISK SPECIFIKATION

- 1 Skal struktur i PP – monoblock
- 2 4-ben eller medstativ, med eller utan armstöd/karm, armstöds-”top” i PP i samma färg som vald färg på skal
- 3 Click-on system. Inga verktyg behövs för att montera stolen

## FÄRGALTERNATIV, SKAL

-  vit
-  svart
-  Antracitgrå
-  Ljusgrå
-  Röd
-  Senapsgul Pantone 7405U



# Milos Elle

design Dorigo



Klädd – slät



Klädd – horisontell stickning på ryggens utsida

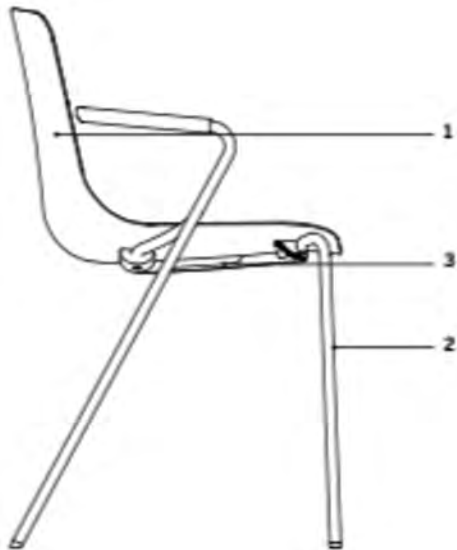

## TEKNISK SPECIFIKATION

- 1 Skal struktur i PP, klädd – monoblock
- 2 4-ben eller medstativ, med eller utan armstöd/karm, armstöds-”top” i PP i samma färg som vald färg på skal
- 3 Click-on system. Inga verktyg behövs för att montera stolen



# Milos Elle

4 ben

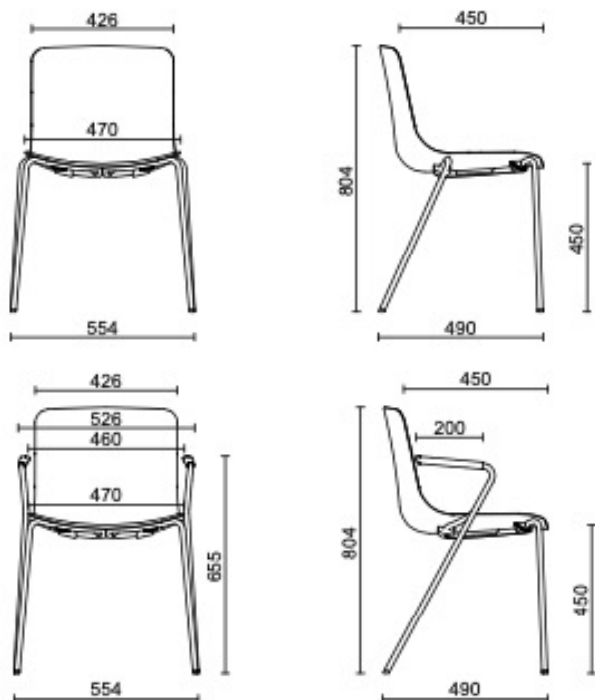

## Grundutförande:

Skalstol i PP – val nedan, ändra position 4 i artikel.nr  
 4 ben – val nedan, ändra position 7 i artikel.nr  
 Staplingsbar - 8 stolar utan karm, 4 stolar med karm  
 Monteras utan verktyg "click-on" system

Minimiorder 4 stolar och delbart med 4, vid order under 4 eller ej delbart med 4 tillkommer 20%

## Tillval:

Karm

Volym: 0,350 / 424 m3  
 Netto vikt: 18,20 / 21,00 kg  
 Gross vikt: 22,20 / 25,35 kg  
 Förpackade: 4/2 krt

1 2 3 4 5 6 7 8 9 10

M E 4 - 0 0 - 0 0 1 Grundutförande - val färg stativ 1, 2 eller 3 2 055 kr  
 val färg skal 3, 2, 4, 5, 7 eller 6

1 2 3 4 5 6 7 8 9 10

-	-	-	-	-	-	1	-	-	-	Ben - Vit	0
-	-	-	-	-	-	2	-	-	-	Ben - Svart	0
-	-	-	-	-	-	3	-	-	-	Ben - Krom	tillägg 150

1 2 3 4 5 6 7 8 9 10

-	-	-	3	-	-	-	-	-	-	Skal - Vit	0
-	-	-	2	-	-	-	-	-	-	Skal - Svart	0
-	-	-	4	-	-	-	-	-	-	Skal - Antracitgrå	0
-	-	-	5	-	-	-	-	-	-	Skal - Ljusgrå	0
-	-	-	7	-	-	-	-	-	-	Skal - Röd	0
-	-	-	6	-	-	-	-	-	-	Skal - Senapsgul	0

1 2 3 4 5 6 7 8 9 10

-	-	-	-	-	A	1/2	-	-	-	Karm med top, ben svart eller vit	tillägg 660
-	-	-	-	-	A	3	-	-	-	Karm med top, ben krom	tillägg 945



# Milos Elle

4 ben - klädd

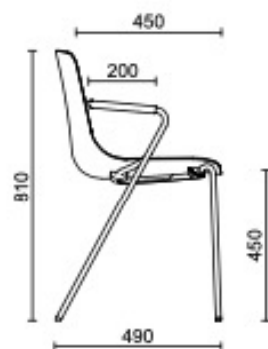

## Grundutförande:

Helklädd skalstol – val nedan  
 4 ben – val nedan, ändra position 7 i artikel.nr  
 Staplingsbar - 8 stolar utan karm, 4 stolar med karm  
 Monteras utan verktyg "click-on" system

Minimiorder 4 stolar och delbart med 4, vid order under 4 eller ej delbart med 4 tillkommer 20%

## Tillval:

Karm

Volym: 0,350 / 424 m<sup>3</sup>  
 Netto vikt: 13,70 / 21,60 kg  
 Gross vikt: 22,80 / 26,00 kg  
 Förpackade: 1/ krt  
 COM, tygåtgång: 1,00 m – Tygbredd: 1,4 m

1 2 3 4 5 6 7 8 9 10

M E 4 0 0 0 - 0 0 1 Grundutförande - val färg stativ 1, 2 eller 4

Pg.1	Pg.2	Pg.3	Pg.4	Pg.5	Pg.9
AL	ME	CH	F-MW-SC-CC	CS-SY	RM
4 305 kr	4 620 kr	4 635 kr	4 875 kr	5 535 kr	5 790 kr

1 2 3 4 5 6 7 8 9 10

-	-	-	-	-	-	1	-	-	-	Ben - Vit	0
-	-	-	-	-	-	2	-	-	-	Ben - Svat	0
-	-	-	-	-	-	3	-	-	-	Ben - Krom	tillägg 165

1 2 3 4 5 6 7 8 9 10

-	-	-	-	-	A	1/2	-	-	-	Karm med top, ben svart eller vit	tillägg 870
-	-	-	-	-	A	3	-	-	-	Karm med top, ben krom	tillägg 1170
-	-	-	8	-	-	-	-	-	-	Horisontell stickning på ryggens utsida	0



# Milos Elle

medstativ

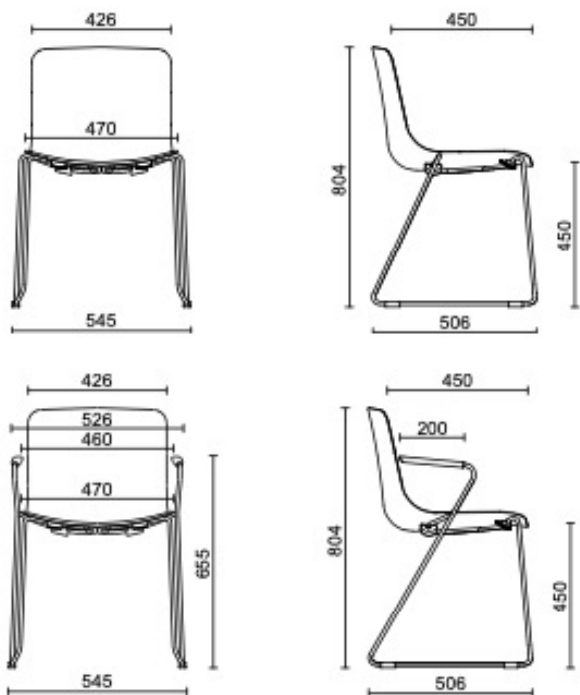

## Grundutförande:

Skalstol i PP – val nedan, ändra position 4 i artikel.nr  
Medstativ – val nedan, ändra position 7 i artikel.nr  
Staplingsbar - 8 stolar utan karm, 4 stolar med karm  
Monteras utan verktyg "click-on" system

Minimiorder 4 stolar och delbart med 4, vid order under 4 eller ej delbart med 4 tillkommer 20%

## Tillval:

Karm

Volym: 0,350 / 424 m3  
Netto vikt: 18,20 / 21,00 kg  
Gross vikt: 22,20 / 25,35 kg  
Förpackade: 4/2 krt

1 2 3 4 5 6 7 8 9 10

M E V - 0 0 - 0 0 1 Grundutförande - val färg stativ 1, 2 eller 3 2340 kr  
val färg skal 3, 2, 4, 5, 7 eller 6

1 2 3 4 5 6 7 8 9 10

- - - - - 1 - - - Medstativ - Vit 0  
- - - - - 2 - - - Medstativ - Svart 0  
- - - - - 3 - - - Medstativ - Krom tillägg 150

1 2 3 4 5 6 7 8 9 10

- - - 3 - - - - - Skal - Vit 0  
- - - 2 - - - - - Skal - Svart 0  
- - - 4 - - - - - Skal - Antracitgrå 0  
- - - 5 - - - - - Skal - Ljusgrå 0  
- - - 7 - - - - - Skal - Röd 0  
- - - 6 - - - - - Skal - Senapsgul 0

1 2 3 4 5 6 7 8 9 10

- - - - - A 1/2 - - - Karm med top, ben svart eller vit tillägg 615  
- - - - - A 3 - - - Karm med top, ben krom tillägg 900

SENAB

22% RABATT SKA DRAS AV PÅ ANGIHVNA PRISER



# Milos Elle

Medstativ - klädd

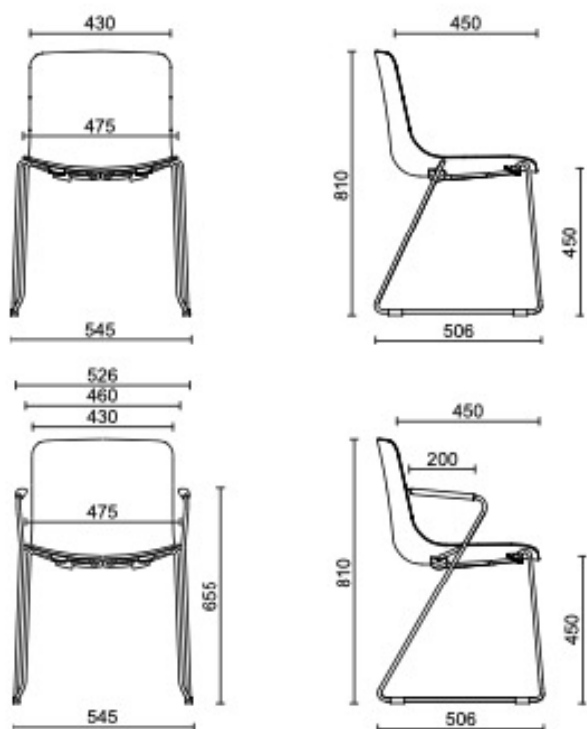

## Grundutförande:

Helklädd skalstol – val nedan  
 Medstativ – val nedan, ändra position 7 i artikel.nr  
 Staplingsbar - 8 stolar utan karm, 4 stolar med karm  
 Monteras utan verktyg "click-on" system

Minimiorder 4 stolar och delbart med 4, vid order under 4 eller ej delbart med 4 tillkommer 20%

**Tillval:**  
 Karm

Volym: 0,350 / 424 m3  
 Netto vikt: 22,40 / 25,20 kg  
 Gross vikt: 26,40 / 30,00 kg  
 Förpackade: 1/ krt  
 COM, tygåtgång 1,00 m – Tygbredd: 1,4 m

1 2 3 4 5 6 7 8 9 10

M E V 0 0 0 - 0 0 1 Grundutförande - val färg stativ 1, 2 eller 4

Pg.1	Pg.2	Pg.3	Pg.4	Pg.5	Pg.9
AL	ME	CH	F-MW-SC-CC	CS-SY	RM
4 500 kr	4 875 kr	4 920 kr	5 160 kr	5 790 kr	5 985 kr

1 2 3 4 5 6 7 8 9 10

-	-	-	-	-	-	1	-	-	-	Medstativ - Vit	0
-	-	-	-	-	-	2	-	-	-	Medstativ - Svat	0
-	-	-	-	-	-	3	-	-	-	Medstativ - Krom	tillägg 165

1 2 3 4 5 6 7 8 9 10

-	-	-	-	-	A	1/2	-	-	-	Karm med top, ben svart eller vit	tillägg 975
-	-	-	-	-	A	3	-	-	-	Karm med top, ben krom	tillägg 1275
-	-	-	8	-	-	-	-	-	-	Horisontell stickning på ryggens utsida	0



# Milos Elle

bar medstativ

## Grundutförande:

Skalstol i PP – val nedan, ändra position 4 i artikel.nr

Sitthöjd 640 eller 740mm – val nedan

Medstativ – val nedan, ändra position 7 i artikel.nr

Monteras utan verktyg "click-on" system

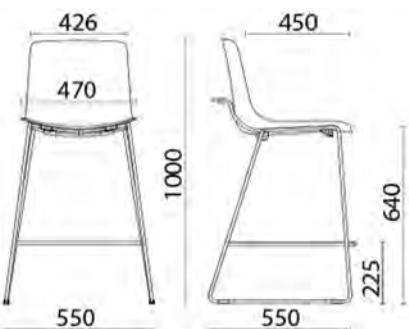
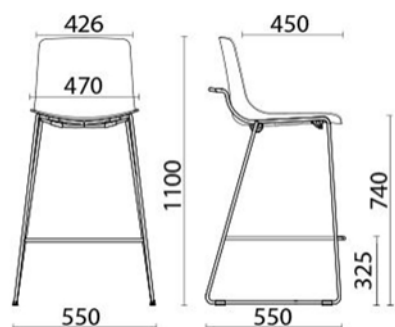

Volym:	0,253 / 0,322 m3
Netto vikt:	8,00 / 8,30 kg
Gross vikt:	10,35 / 10,65 kg
Förpackade:	1 krt

1	2	3	4	5	6	7	8	9	10	Sitthöjd 640	
M	E	S	3	0	0	-	0	0	2	Grundutförande - val färg stativ 1, 2 eller 3 val färg skal 3, 2, 4, 5, 7 eller 6	3 600 kr
1	2	3	4	5	6	7	8	9	10	Sitthöjd 740	
M	E	T	3	0	0	-	0	0	2	Grundutförande - val färg stativ 1, 2 eller 3 val färg skal 3, 2, 4, 5, 7 eller 6	4 020 kr

1	2	3	4	5	6	7	8	9	10		
-	-	-	-	-	-	1	-	-	-	Medstativ, vit	0
-	-	-	-	-	-	2	-	-	-	Medstativ, svart	0
-	-	-	-	-	-	3	-	-	-	Medstativ, krom	tillägg 315

1	2	3	4	5	6	7	8	9	10		
-	-	-	3	-	-	-	-	-	-	Skal - Vit	0
-	-	-	2	-	-	-	-	-	-	Skal - Svart	0
-	-	-	4	-	-	-	-	-	-	Skal - Antracitgrå	0
-	-	-	5	-	-	-	-	-	-	Skal - Ljusgrå	0
-	-	-	7	-	-	-	-	-	-	Skal - Röd	0
-	-	-	6	-	-	-	-	-	-	Skal - Senapsgul	0





# Milos Elle

bar medstativ - klädd

## Grundutförande:

Helklädd skalstol i PP – val nedan  
 Sitthöjd 640 eller 740mm – val nedan  
 Medstativ – val nedan, ändra position 7 i artikel.nr  
 Monteras utan verktyg "click-on" system

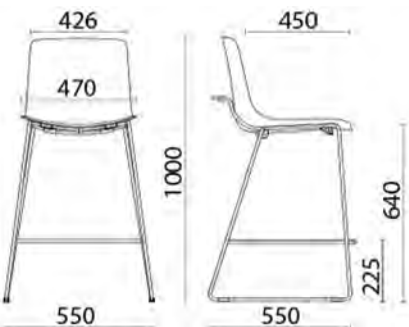
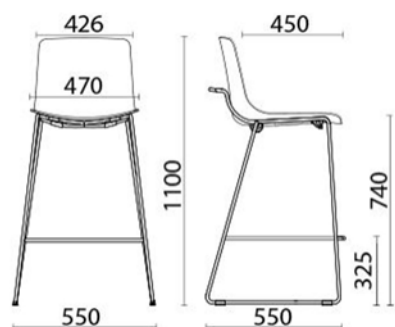

Volym: 0,253 / 0,322 m<sup>3</sup>  
 Netto vikt: 8,60 / 8,90 kg  
 Gross vikt: 10,95 / 11,25 kg  
 Förpackade: 1 krt  
 COM, tygätgång: 1,00 m – Tygbredd: 1,4 m

1 2 3 4 5 6 7 8 9 10

Sitthöjd 640

M E S 0 0 0 - 0 0 2

Grundutförande - val färg stativ 1, 2 eller 4

Pg.1	Pg.2	Pg.3	Pg.4	Pg.5	Pg.9
AL	ME	CH	F-MW-SC-CO	CS-SY	RM
5 985 kr	6 360 kr	6 375 kr	6 615 kr	7 245 kr	7 800 kr

1 2 3 4 5 6 7 8 9 10

Sitthöjd 740

M E T 0 0 0 - 0 0 2

Grundutförande - val färg stativ 1, 2 eller 4

6 495 kr	6 915 kr	6 930 kr	7 080 kr	7 905 kr	8 325 kr
----------	----------	----------	----------	----------	----------

1 2 3 4 5 6 7 8 9 10

- - - - - 1 - - -

Medstativ - Vit

0

- - - - - 2 - - -

Medstativ - Svat

0

- - - - - 3 - - -

Medstativ - Krom

tillägg

330

1 2 3 4 5 6 7 8 9 10

- - - 8 - - - - -

Horisontell stickning på ryggens utsida

0



# Uni

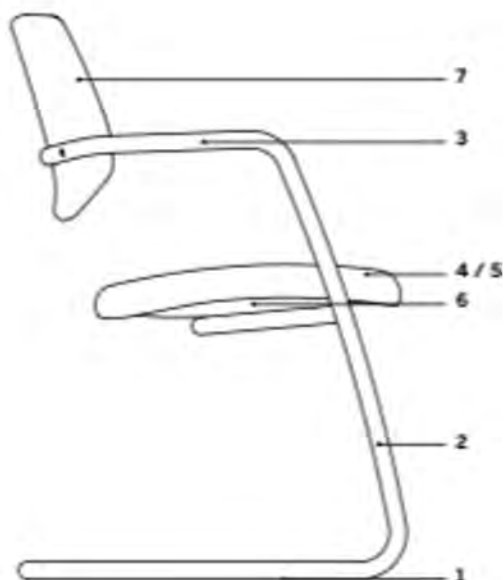

## TEKNISK SPECIFIKATION

- 1 Anti-glid
- 2 Medstativ i stål  $\varnothing$  20mm
- 3 Integrerad karm
- 4 Inre struktur i trä (bok) - sits
- 5 Sits i PU "Comfort Air" teknik
- 6 Skal i svart PP
- 7 Inre struktur i PP - rygg



# Uni

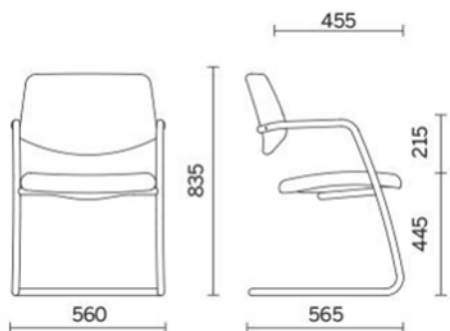
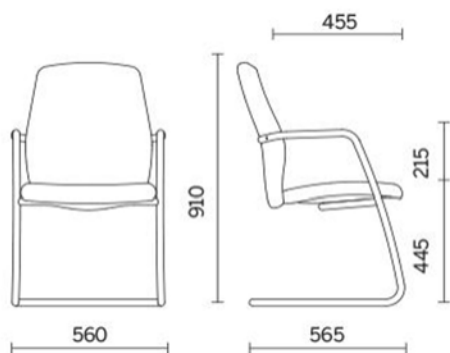

## Grundutförande:

Hög eller låg rygg – val nedan, ändra position 4 i artikel.nr  
 Helklädd sits och rygg – val nedan  
 Medstativ i svart med armstödstop i svart

## Tillval:

Medstativ i krom  
 Glidfötter i filt för ömtåliga golv

Säljs i 2-pack, vid bruten frp. + 10%

Volym: 0,406 / 520 m3  
 Netto vikt: 22,00 / 22,70 kg  
 Gross vikt: 24,60 / 25,30 kg  
 Förpackade: 2 krt  
 COM, tyngtgång 0,80 / 1,10 m – Tygbredd: 1,4 m

1 2 3 4 5 6 7 8 9 10

U N V M 3 3 1 B 0 0 Grundutförande - Låg rygg, svart

U N V H 3 3 1 B 0 0 Grundutförande - Hög rygg, svart

Pg.1	Pg.2	Pg.3	Pg.4	Pg.5	Pg.A	Pg.B	Pg.E
NX-AL-BN	AB-ME	CH	MW-MF-ST-SC-COM	CS-SY-WI	SX+NX	SX	PA
3 300 kr	3 540 kr	3 645 kr	3 990 kr	4 395 kr	4 965 kr	6 870 kr	7 125 kr
3 675 kr	3 915 kr	4 080 kr	4 500 kr	5 190 kr	5 880 kr	7 650 kr	7 935 kr

- - - - - D - - Medstativ i krom tillägg 645 kr

- - - - - 1 - Glid i filt tillägg 300 kr



# Unimesh

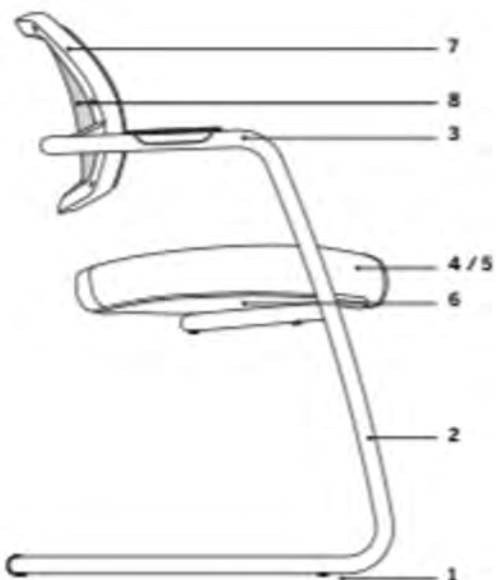

## TEKNISK SPECIFIKATION

- 1 Anti-glid
- 2 Medstativ i stål  $\varnothing$  20mm
- 3 Integrerad karm med svart top i PP
- 4 Inre struktur i PP - sits
- 5 Sits i PU "Comfort Air" teknik
- 6 Skal i svart PP
- 7 Ryggens ram i PP
- 8 Rygg i mesh



# Unimesh

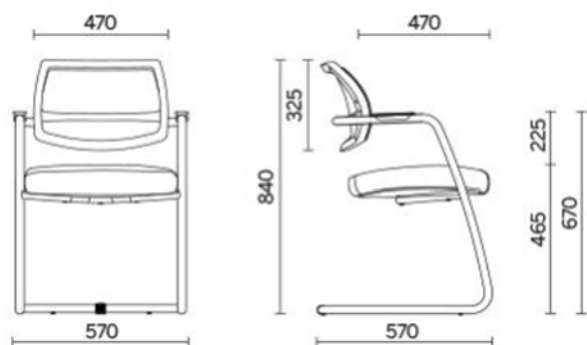

## Grundutförande:

Låg rygg  
Helklädd sits – val nedan  
Meshrygg – val nedan  
Medstativ i svart med armstödstop i svart

## Tillval:

Medstativ i krom  
Medstativ i ljusgrått  
Ryggens ram och armstöds top i ljusgrått  
Glidfötter i filt för ömtåliga golv

Säljs i 2-pack, vid bruten frp. + 10%

Volym: 0,340 m3  
Netto vikt: 21,20 kg  
Gross vikt: 23,80 kg  
Förpackade: 2 krt  
COM, tygätgång 0,60 m – Tygbredd: 1,4 m

1 2 3 4 5 6 7 8 9 10

U M I R 1 0 0 B 0 0 Grundutförande - svart  
U M I R 1 0 0 B 0 0 Grundutförande - svart  
U M I R 1 0 0 B 0 0 Grundutförande - svart

	Pg.1 NX-AL-BN	Pg.2 AB-ME	Pg.3 CH	Pg.4 WF-WM-SC- ST-ROOM	Pg.5 CS-SY-WI
Rygg mesh RF	3 540 kr	3 690 kr	3 765 kr	3 795 kr	4 440 kr
RP, RR	3 585 kr	3 705 kr	3 795 kr	3 825 kr	4 500 kr
RY	3 690 kr	3 855 kr	3 915 kr	3 945 kr	4 650 kr

-	-	-	-	-	-	D	-	-	Medstativ i krom	tillägg	630 kr
-	-	-	-	-	-	G	-	-	Medstativ i ljusgrå	tillägg	240 kr
-	-	-	-	2	-	-	-	-	Ryggens ram och armstöds top i ljusgrått	tillägg	180 kr
-	-	-	-	-	-	-	1	-	Glid i filt	tillägg	300 kr



# Passe-partout

design Sergio Bellin

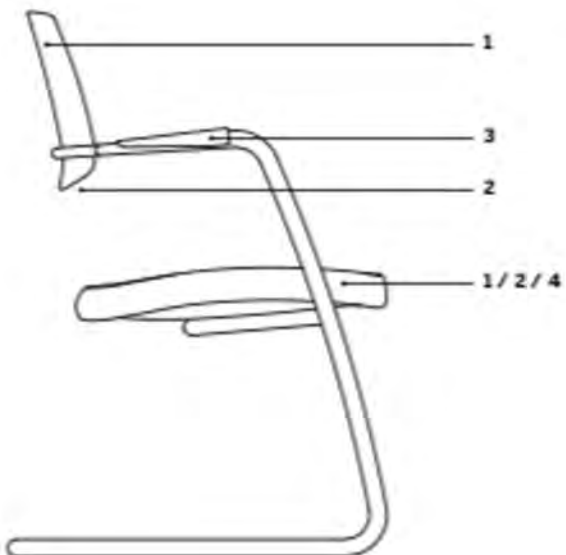

## TEKNISK SPECIFIKATION

- 1 Inre struktur i PP – sits och rygg
- 2 Skal, svart PP - sits
- 3 Integrerad karm med top i svart PP
- 4 Sits i PU "Comfort Air" teknik



# Passe-partout Meeting



## Grundutförande:

Stativ i svartlackerad stål med integrerad karm, top i svart PP  
 Hög eller låg rygg – val nedan, ändra position 3 i artikel.nr  
 Helklädd sits och rygg – val nedan  
 5 fotkryss i stålförstärkt PA, svart  
 Hjul  $\varnothing$  65mm – val nedan, ändra position 9 i artikel.nr

## Höjdjustering

## Tillval:

Hjul  $\varnothing$  65 mm, ihåliga – val nedan, ändra position 9 i artikel.nr  
 Stativ i krom, med polerat aluminium 5 fotkryss

Volym: 0,309 / 341 m<sup>3</sup>  
 Netto vikt: 11,50 / 22,70 kg  
 Gross vikt: 14,70 / 25,30 kg  
 Förpackade: 1 krt  
 COM, tyngtgång 0,80 / 1,10 m – Tygbredd: 1,4 m

1 2 3 4 5 6 7 8 9 10

P S 0 0 G 1 1 1 - 0 Grundutförande - Låg rygg, svart

P S 1 0 G 1 1 1 - 0 Grundutförande - Hög rygg, svart

Pg.1	Pg.2	Pg.3	Pg.4	Pg.5	Pg.A	Pg.B
NX-AL-BN	AB-ME	CH	MF-MW-ST-COM	CS-SY-WI	SX+NX	SX
6 825 kr	7 035 kr	7 290 kr	7 605 kr	8 115 kr	8 715 kr	9 900 kr
7 080 kr	7 365 kr	7 605 kr	7 935 kr	8 475 kr	9 345 kr	11 325 kr

1 2 3 4 5 6 7 8 9 10

-	-	-	-	-	-	-	-	7	-	$\varnothing$ 65 mm, obromsat, för matta	0
-	-	-	-	-	-	-	-	8	-	$\varnothing$ 65 mm, bromsat, för matta	0
-	-	-	-	-	-	-	-	9	-	$\varnothing$ 65 mm, bromsat, för hårt golv	0
-	-	-	-	-	-	-	-	N	-	$\varnothing$ 65 mm, ihåligt, svart	tillägg 420 kr
-	-	-	-	-	-	-	-	C	-	$\varnothing$ 65 mm, ihåligt, krom	tillägg 465 kr

- - - - - 3 - 4 - - Stativ i krom och 5-fotkryss i polerad aluminium tillägg 1 875 kr



# Passe-partout Visitor

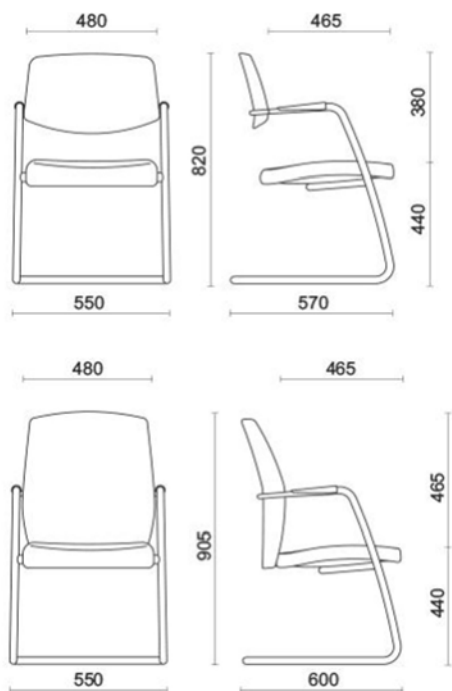

## Grundutförande:

Medstativ i svartlackerad stål med armstödstop i svart  
 Hög eller låg rygg – val nedan, ändra position 3 i artikel.nr  
 Helklädd sits – val nedan

## Tillval:

Medstativ i krom  
 Glidfötter i filt för ömtåliga golv

Säljs i 2-pack, vid bruten frp. + 10%

Volym: 0,404 / 486 m<sup>3</sup>  
 Netto vikt: 9,20 / 9,40 kg  
 Gross vikt: 10,70 / 11,00 kg  
 Förpackade: 2 krt  
 COM, tygätgång 0,80 / 1,10 m – Tygbredd: 1,4 m

1	2	3	4	5	6	7	8	9	10		Pg.1 NX-AL-BN	Pg.2 AB-ME	Pg.3 CH	Pg.4 MF-MW-ST- COM	Pg.5 CS-SY-WI	Pg.A SX+NX	Pg.B SX
P	S	0	0	C	1	0	0	0	0	Grundutförande - Låg rygg, svart	3 435 kr	3 720 kr	3 915 kr	4 140 kr	4 680 kr	5 280 kr	6 510 kr
P	S	1	0	C	1	0	0	0	0	Grundutförande - Hög rygg, svart	3 990 kr	4 485 kr	4 695 kr	4 950 kr	5 550 kr	6 405 kr	8 190 kr

-	-	-	-	-	3	-	-	-	-	Medstativ i krom						tillägg	855 kr
-	-	-	-	-	-	-	-	-	1	Glid i filt						tillägg	300 kr





# Green'S

design Baldanzi & Novelli

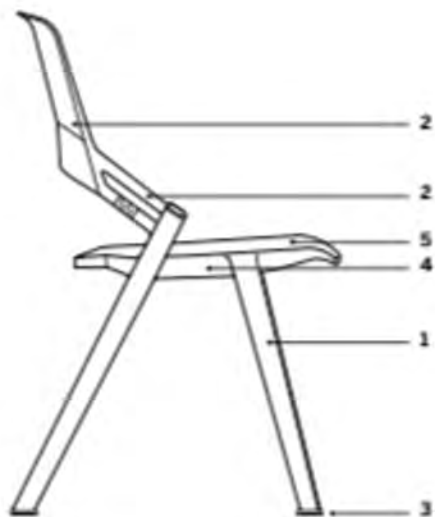

## TEKNISK SPECIFIKATION

- 1 Struktur i PP, 4 ben utan armstöd – lätt att lägga till armstöd (A) med eller utan skrivplatta (B)
- 2 Flexibel "svikt" i ryggen
- 3 Anti-glid fötter
- 4 Kopplings beslag
- 5 Avtagbar dyna, "Classic" eller "Super Comfort" (D)
- 5 Avtagbar dyna, "Tecno" (E)



GREEN  
100% återvinningsbart.

BEKVÄMLIGHET  
Green'S one-shell struktur har ett innovativt patenterat system som kallas "flexsystem".

TRANSFORMERBAR  
Green'S har ett brett utbud av tillval som enkelt kan monteras och demonteras. Armstöd, skrivplatta, dyna, snabbkopplingssystem, vilket ger möjlighet att välja den mest lämpliga versionen för era behov.  
Green'S kan enkelt staplas och lastas på en vagn för att smidigt kunna köras undan och lagras

RESISTENTA  
Green'S är tillverkat av ett massivt plastmaterial, beständigt mot UV-strålar och vatten. En produkt som uppfyller behoven i såväl klassrum, mötesrum, konferenslokaler, väntrum och även utomhusutrymmen.

## FÄRGALTERNATIV, SKAL

-  vit
-  Medium grå
-  Ljusgrå (RAL 7035)

SENAB

**22%** RABATT SKA DRAS AV PÅ ANGIVNA PRISER



# Green'S

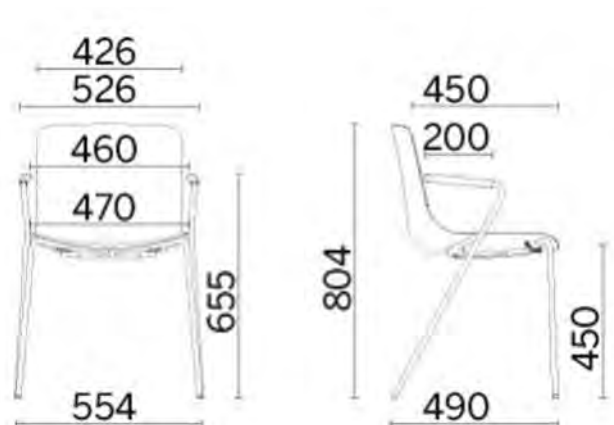

## Grundutförande:

Gjuten stol i PP – val färg nedan, ändra position 5 i artikel.nr  
Staplingsbar - 15 stolar utan armstöd, 10 stolar med armstöd

Minimiorder 4 stolar och delbart med 4, vid order under 4 eller ej delbart med 4 tillkommer 10%

## Tillval:

Armstöd  
Skrivplatta  
Kopplingsbeslag  
Löstagbar dyna

Volym: 0,418 m3  
Netto vikt: 5,35 kg  
Gross vikt: 4,50 kg  
Förpackade: 4 / krt

1 2 3 4 5 6 7 8 9 10

G R 4 A - A 0 0 0 0 Grundutförande - val strukturfärg 1, C eller 4

2 325 kr

1 2 3 4 5 6 7 8 9 10

- - - - 1 - - - - - Strukturfärg - vit

0

- - - - C - - - - - Strukturfärg - mediumgrå

0

1 2 3 4 5 6 7 8 9 10

G R B R 0 - Armstöd, par

Volym: 0,0035 m2 Netto vikt: 0,57 kg Gross vikt: 0,64 kg Förpackade: 4 / krt

600

G R B R 1 T A V 0 - 1 st - Höger armstöd med skrivplatta, höger

Volym: 0,0019 m2 Netto vikt: 1,53 kg Gross vikt: 2,00 kg Förpackade: 1 / krt

1770

G R B R 2 T A V 0 - 1 par - Armstöd med skrivplatta, höger

Volym: 0,0019 m2 Netto vikt: 1,53 kg Gross vikt: 2,00 kg Förpackade: 1 / krt

2025

G R A G G L 1 - Långt kopplingsbeslag - för stolar med ett par armstöd eller ett par med skrivplatta höger

315

1 = vit C = mediumgrå

1 2 3 4 5 6 7 8 9 10

G R S E D C 4 Dyna i polyuretan skum, med en central stickning, Classic

Pg.1	Pg.2	Pg.4	Pg.5
NX-AL-BN	AB-ME	COM	SY
600 kr	690 kr	765 kr	1035 kr
990 kr	1065 kr	1155 kr	1575 kr

G R S E D 0 4 Dyna i polyuretan skum, 29mm, Super Comfort

G R C A R 0 0 0 Vagn med hjul till Green'S

2745 kr

SENAB

22% RABATT SKA DRAS AV PÅ ANGIVNA PRISER



# Använda prislistan

## 1. Product code composition

The product codes are made of a matrix (10 digits for the chair) followed by the upholstery references.

Product code										Upholstery code							
1	2	3	4	5	6	7	8	9	10	11	12	13	14	15	16	17	18
M	I	A	O	7	D	C	1	8	2								

For a correct order, please verify the code of reference and the variation that may occur in the price.

NOTE: for products with upholstery cat. "A", (real leather cat. SX on the parts which are in contact with the user, combined with ecological leather cat. NX for the rear and side parts), it is necessary to indicate the code for the real leather first, and then the code of the matching colour for the ecological leather. For your convenience, the two upholsteries have the same colour codes.

E.g. Grace manager upholstered in real leather cat. SX combined with ecological leather cat. NX

Product code										Upholstery code							
1	2	3	4	5	6	7	8	9	10	11	12	13	14	15	16	17	18
G	A	M	O	O	B	O	7	O	6	S	X	O	1	N	X	O	1

In the case of products with two-tone upholstery, the first 4 characters of the upholstery code (from 11 to 14) refer to the colour of the seat while the last 4 characters (from 15 to 18) refer to the colour of the backrest or the shell.

E.g. Milos Life with two-tone upholstery

Product code										Front colour				Back colour			
1	2	3	4	5	6	7	8	9	10	11	12	13	14	15	16	17	18
M	I	A	A	O	A	A	2	O	O	M	E	O	1	M	E	O	4

E.g. Cell128 with two-tone upholstery

Product code										Colour seat				Body colour			
1	2	3	4	5	6	7	8	9	10	11	12	13	14	15	16	17	18
C	E	1	A	O	O	O	O	O	1	M	E	O	1	M	E	O	4

E.g. Milos Life with protruding arms

Product code									
1	2	3	4	5	6	7	8	9	10
M	I	A	A	7	-	C	1	8	2

Product code									
1	2	3	4	5	6	7	8	9	10
M	I	A	A	7	D	C	1	8	2

To select an option, please replace the "-" symbol with the character corresponding to the selected option.

## 2. Materials

Sitland uses high quality materials combined with advanced manufacturing processes.

The plastic materials are carefully selected, as well as the steel used for the production of the cantilever chairs: high resistant special steel, which allows the chairs to be light and at the same time very strong. A special attention is given to the chrome and painting processes with epoxy powders, ensuring an extremely high level, long lasting in time, proof of Sitland's quality.

The aluminium is polished, to emphasize its natural aesthetic qualities.



### 3. Upholstery vademecum

Category	Code	Name	Manufacturer	Material composition	Characteristics of the material
1	AL	Alba	FIDIVI	100% PL 100.000 Martindale	
	BN	Bondai	FIDIVI	100% PL 150.000 Martindale	
	NX			91% PVC, 9% PL 60.000 Martindale	
2	ME	Medley	Gabriel	100% PL 75.000 Martindale	
	AB	Xtreme Plus	Camira	100% post-consumer recycled PL 100.000 Martindale	
	RF	Polo	FIDIVI Service	100% PL 100.000 Martindale	
3	CH	CHill	Gabriel	100% PL Fr riciclato post-consumo, 60.000 Martindale	
	RR	Runner	Gabriel	100% PL 70.000 Martindale	
	RP	Net Medium	Serge Ferrari	70% PVC, 30% PL 100.000 Martindale	
4	RY	Rhythm	Gabriel	100% PL Fr 100.000 Martindale	
	ST	Step	Gabriel	100% PL riciclato post-consumo 100.000 Martindale	
	SC	Secret	Flukoa	76% PVC, 2% PU, 22% PES 60.000 Martindale	
	RG	Regent	Camira	100% PL Fr 50.000 Martindale	
	ME	Main Line Flax	Camira	75% Virgin Wool, 25% Flax 50.000 Martindale	
	MW	Main Line Telsi	Camira	75% Virgin Wool, 25% Flax 50.000 Martindale	
5	CS	Crep	Gabriel	93% W della Nuova Zelanda, 7% PA 200.000 Martindale	
	SY	Synergy	Camira	95% WV, 5% PA 100.000 Martindale	
	FT	Foster	Vascom	97% recycled polyester FR / 3% polyester FR 60.000 Martindale	
	WI	Wilson	Vascom	100% PL Fr riciclato 80.000 Martindale	
	IR	Iron	FIDIVI Service	100% PL 100.000 Martindale	
	YD	Yoredale	Camira	95% W, 3% PL, 2% PA 50.000 Martindale	
9	RM	Remix 3	90% new wool, worsted 10% nylon 100.000 Martindale		
10	RW	Re-Wool	45% recycled wool 45% new wool, worsted 10% nylon 100.000 Martindale		
	HE	Hero 2	97% new wool 3% recycled nylon 45.000 Martindale		
11	FD	Fjord 3	92% new wool, worsted 8% nylon 60.000 Martindale		
	S1	Sleatcol 3	90% new wool, worsted 10% nylon 100.000 Martindale		
	SE	Sleatcol Trio 3	90% new wool, worsted 10% nylon 100.000 Martindale		
	S4	Sleatcol Quartel	90% new wool, worsted 10% nylon 100.000 Martindale		





Category	Code	Name	Manufacturer	Material composition	Characteristics of the material
A	SX + NX	SX + NX			
B	SX	Box Land	Dani		
E	PA	Panama	Dani		
C	TS	Florida	Dani		
D	TU/ TX	TU/ TX	Mastrolio		

Symbol	Description
	No heavy metals
	EU Ecolabel is a European brand that certifies the reduced environmental impact of the product
	Modified polyester fiber "Permanent Flame Retardant": capable of preserving the flame retardant properties of the fiber with aging, wear and washing. Fabrics made with Trevira CS fiber pass the most severe reaction to fire tests worldwide, reaching the best classification everywhere (Class 1 in Italy)
	GREENGUARD Certification is a European brand that certifies the low level of chemical emissions
	The Deko-Tex® STANDARD 100 label guarantees that every component of the article, has been tested for harmful substances and that the article therefore is harmless in human ecological terms
	hinders bacteria growth and odor development, built-in durable protection thanks to the Sanitized® hygiene function
	Der Isaac Engel (RAL UZ 148) it sets stricter limits for dangerous substance content, the emission of pollutants and the use of raw materials and water than those indicated by law
	Leather from Italy full cycle (UNI EN 16484) certifies that all the production processes are carried out in Italy
	Carbon footprint of product (ISO 14067: 2018) quantifies the greenhouse gas emissions along the supply chain, from farming and rearing to realization of the finished leather
	Environmental product declaration & process EPD (ISO 14025) Following the LCA (Life Cycle Assessment) study, the following impact categories are estimated: greenhouse effect, reduction in the ozone layer, acidification, photochemical smog, eutrophication
	Real leather
	Flame retardant
	Recyclable
	Recycled
PA	Polyamide
PL	Polyester
PL F1	Flame retardant polyester
Tr Cs	Trevira CS
W	Wool
WV	Virgin Wool



## 4. Fabric needed

The fabric needed of each product is indicated in each price list.

The fabric needed is indicative and it refers to a one-colour bi-elastic upholstery H 140 cm.

For different types of coating (not elastic, printed, etc.) consumption and prices will be evaluated only after preliminary feasibility assessments.

Note: for versions with back mesh, the consumption refers to the seat upholstery.

## 5. Two-tone upholstery

Some products can be made with two-colour upholstery. This option is indicated in the upholstery categories with  (two-tone). The two-tone upholstery option provides for a 10% increase to the list price.

In the case of products with two-tone upholstery, the first 4 characters of the upholstery code (from 11 to 14) refer to the colour of the seat while the last 4 characters (from 15 to 18) refer to the colour of the backrest or the shell.

E.g. Milos Life with two-tone upholstery

Product code										Front colour				Back colour			
1	2	3	4	5	6	7	8	9	10	11	12	13	14	15	16	17	18
M	I	A	A	O	A	A	2	O	O	M	E	O	1	M	E	O	4

## 6. Packaging

The products are supplied in single or multiple packaging.

E.g. individually packed product: 1X 

E.g. product divided into 2 packages: 1X 

E.g. multiple packaging: 2X 

In the case of seats packed 2 per box or 4 per box, for orders with quantities of less than 2 or 4 and their multiples, a price increase equal to 10% of the price list will be applied unless otherwise agreed. For any information contact [service@sitland.com](mailto:service@sitland.com)

## 7. Schemes, measures and models

The dimensional drawings of the pricelists show the measurements by considering a user of about 60 kg sitting.

Sitland spa reserves the right to make changes and / or technical and aesthetic improvements to the models and products at any time and without notice.

## 8. Comfort Air System

Team Strike, Invicta Point, Invicta Balance, Soffio, Mesh-Line, Team W, Be Quadra, Uni, Unimesh, Fresh, Fresh Air, PK and Passe-partout are produced with Comfort Air System foam, flexible and crushproof. In the seat foam there are small air spaces that keep the air in such a way to grant a superior comfort; thanks to this technology, the material used to make the foam is reduced, with a sensible benefit to environmental impact.

For any further information, please contact our Customer Service at [service@sitland.com](mailto:service@sitland.com)

## 9. Orders sending

We kindly ask you to send your orders exclusively to our order department at [order@sitland.com](mailto:order@sitland.com) or through the fax no. +39 0444 638 407.



# Tessuti / Fabrics / Gewebe / Tissus / Tejidos

AL  
FiDiVi, Alba

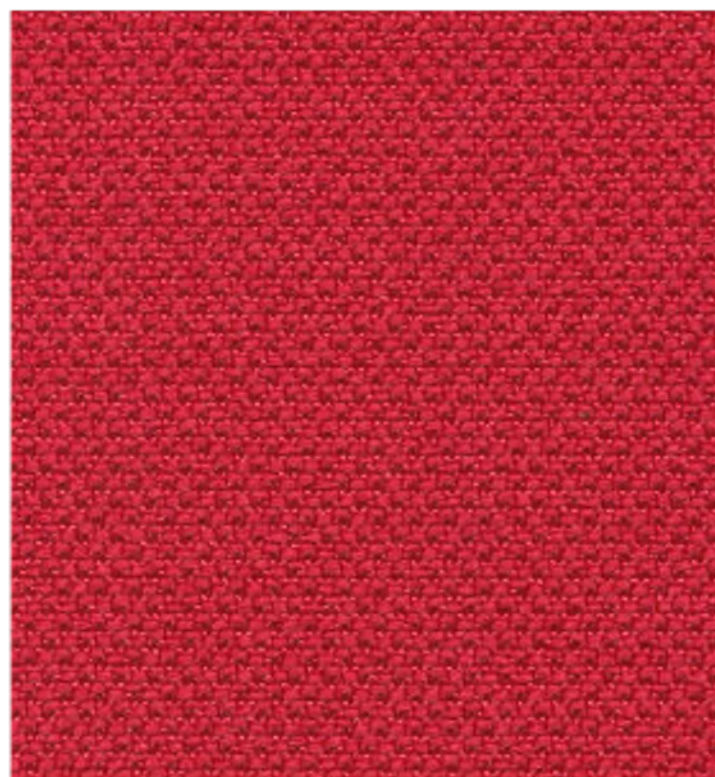

AL07\_Alba 4027

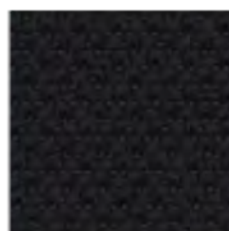

AL01\_Alba 8033



AL02\_Alba 8003

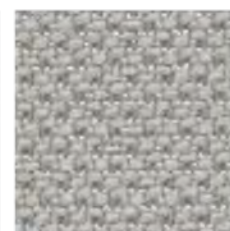

AL03\_Alba 8078

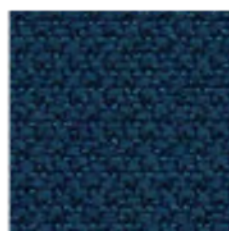

AL05\_Alba 6098

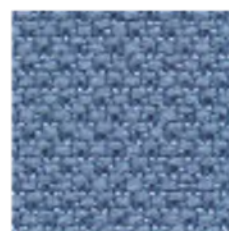

AL21\_Alba 6006



AL09\_Alba 6007

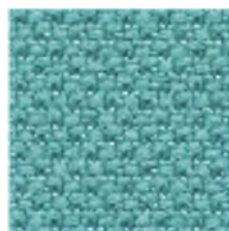

AL36\_Alba 7026



AL19\_Alba 1006

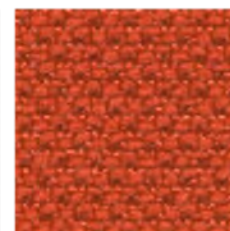

AL13\_Alba 4004



AL07\_Alba 4027





# Tessuti / Fabrics / Gewebe / Tissus / Tejidos

BN  
FiDiVi, Bondai



BN07\_Bondai 7048



BN01\_Bondai 8033



BN04\_Bondai 8030



BN18\_Bondai 8078



BN00\_Bondai 6098

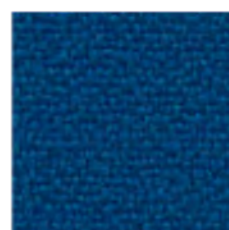

BN02\_Bondai 6036

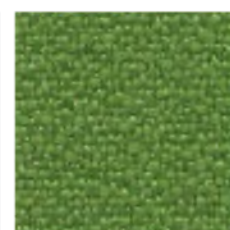

BN17\_Bondai 7048



BN12\_Bondai 7021



BN20\_Bondai 1008



BN24\_Bondai 3005



BN09\_Bondai 3012

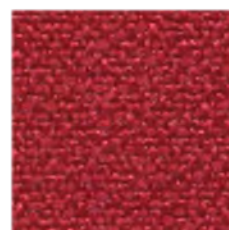

BN05\_Bondai 4011





# Pelli ed ecopelli / Leathers and faux leather / Leder und Kunstleder / Cuir et faux cuir / Cueros y imitación de cuero

NX  
Lederplast



# Tessuti / Fabrics / Gewebe / Tissus / Tejidos

ME  
Gabriel, Medley



ME13\_Medley 68005



ME01\_Medley 60999



ME02\_Medley 60004



ME03\_Medley 60003



ME09\_Medley 66030

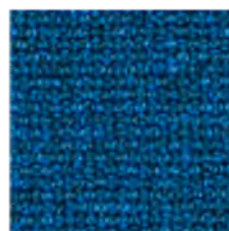

ME15\_Medley 66007

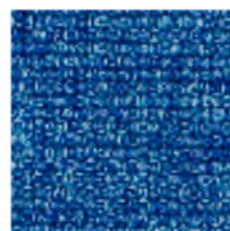

ME08\_Medley 66009



ME16\_Medley 66008



ME13\_Medley 68005



ME11\_Medley 68002



ME04\_Medley 61002



ME07\_Medley 65011

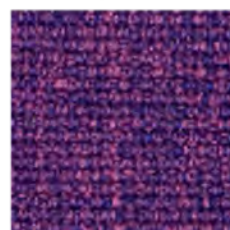

ME17\_Medley 65012



ME18\_Medley 64019

sitland  
SENAB

**22%** RABATT SKA DRAS AV PÅ ANGIVNA PRISER





# Tessuti / Fabrics / Gewebe / Tissus / Tejidos

AB  
Camira, Xtreme Plus

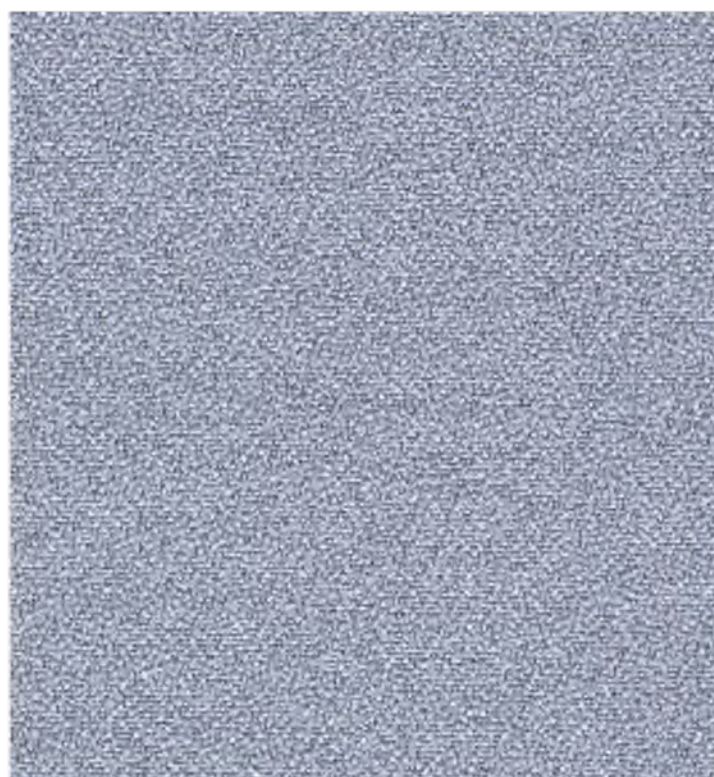

AB47\_Xtreme YS173



AB03\_Xtreme YS009



AB51\_Xtreme YS172



AB38\_Xtreme YS046



AB12\_Xtreme YS081



AB47\_Xtreme YS173



AB04\_Xtreme YS082

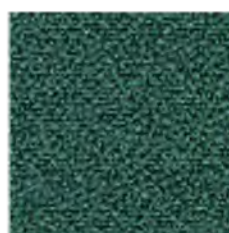

AB40\_Xtreme YS047

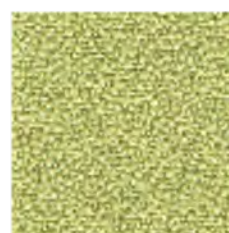

AB25\_Xtreme YS096



AB17\_Xtreme YS308



AB34\_Xtreme YS091

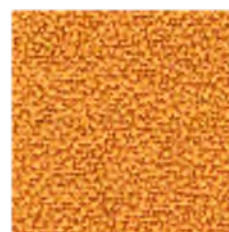

AB37\_Xtreme YS072



AB15\_Xtreme YS079



AB21\_Xtreme YS302

sitland  
SENAB

**22%** RABATT SKA DRAS AV PÅ ANGIVNA PRISER



# Reti / Meshes / Maschen / Mailles / Mallas

RF  
FiDiVi Service, Polo



RF01

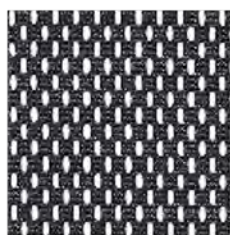

RF01

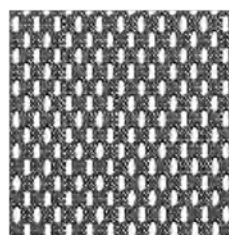

RF04



R702



RF05

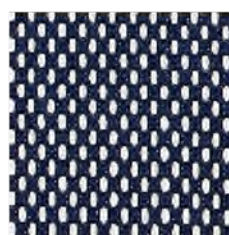

RF03





# Tessuti / Fabrics / Gewebe / Tissus / Tejidos

CH  
Gabriel, Chili

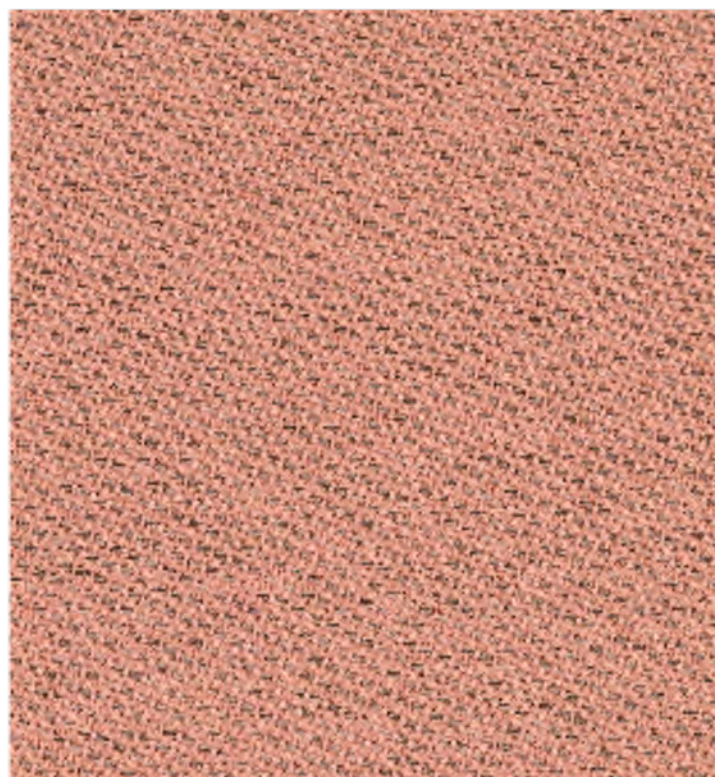

CH22\_Chil 63092



CH13\_Chil 60999



CH14\_Chil 61171



CH15\_Chil 61174

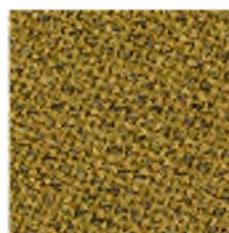

CH17\_Chil 68198



CH16\_Chil 61172

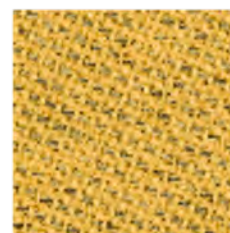

CH25\_Chil 62086

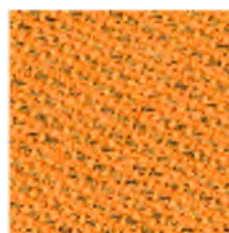

CH24\_Chil 63093

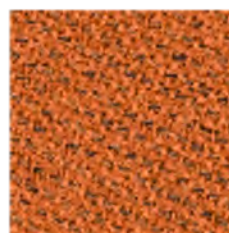

CH23\_Chil 63099

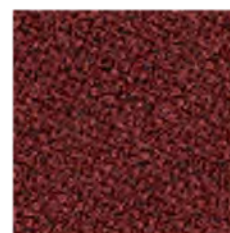

CH21\_Chil 64203



CH19\_Chil 65110

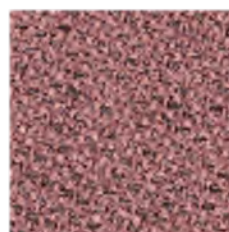

CH20\_Chil 65111



CH22\_Chil 63092

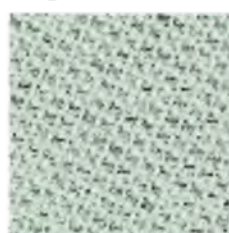

CH18\_Chil 68191

sitland  
SENAB

**22%** RABATT SKA DRAS AV PÅ ANGIHVNA PRISER





# Reti / Meshes / Maschen / Mailles / Mallas

RR  
Gabriel, Runner

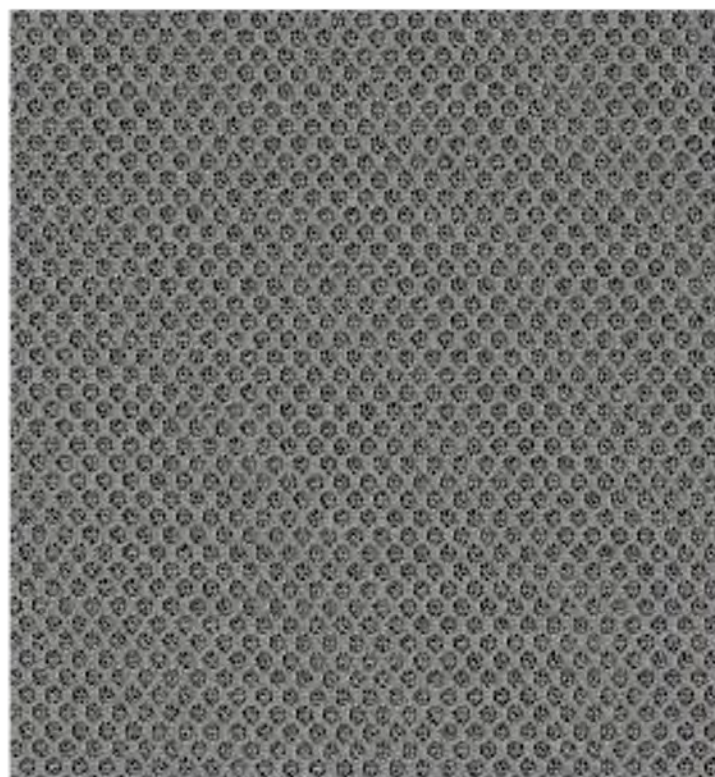

RR03\_Runner 60011



RR01\_Runner 60999



RR02\_Runner 60025



RR03\_Runner 60011



RR14\_Runner 60165



RR08\_Runner 66064



RR12\_Runner 66140



RR09\_Runner 65078



RR15\_Runner 66063



RR05\_Runner 68056



RR13\_Runner 61110



RR06\_Runner 63034

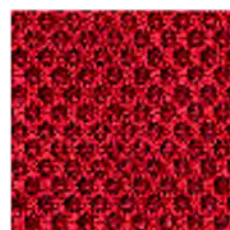

RR07\_Runner 64089





# Reti / Meshes / Maschen / Mailles / Mallas

RP  
Plastitex. Net Medium

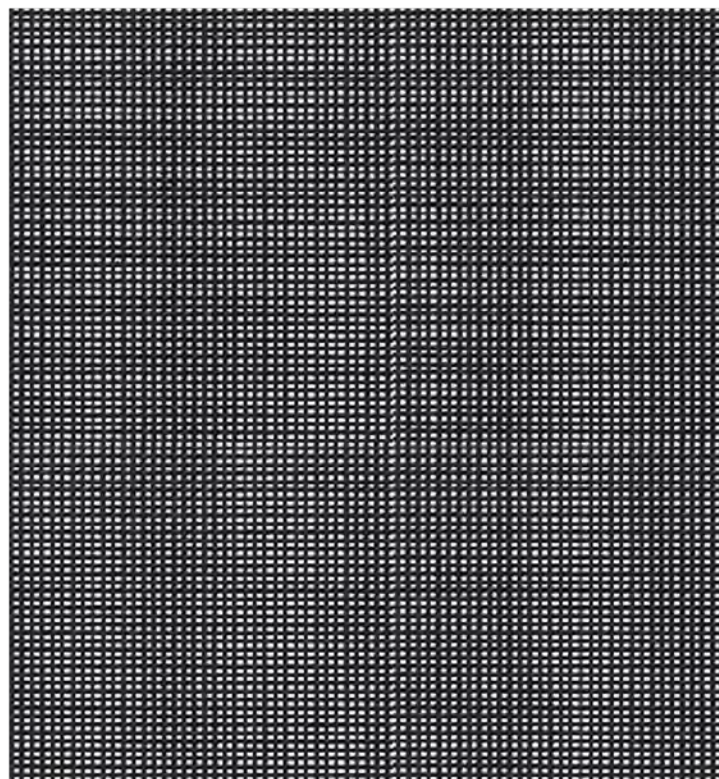

RP10

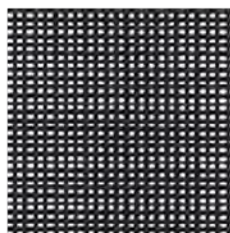

RP10

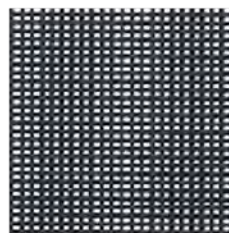

RP11

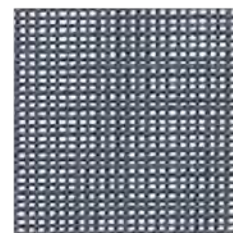

RP12

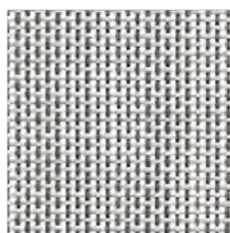

RP21

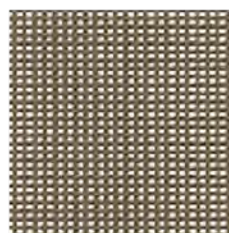

RP20



# Reti / Meshes / Maschen / Mailles / Mallas

**RY**  
**Gabriel, Rhythm**



RY03\_Rhythm 60165



RY01\_Rhythm 60999



RY02\_Rhythm 60025



RY03\_Rhythm 60165



RY09\_Rhythm 66152

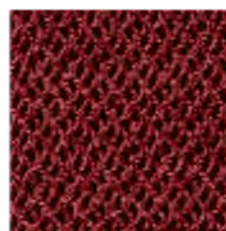

RY06\_Rhythm 63068

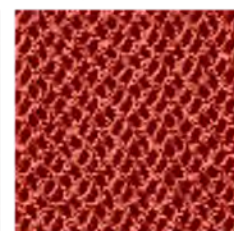

RY12\_Rhythm 63067





# Tessuti / Fabrics / Gewebe / Tissus / Tejidos

ST  
Gabriel, Step

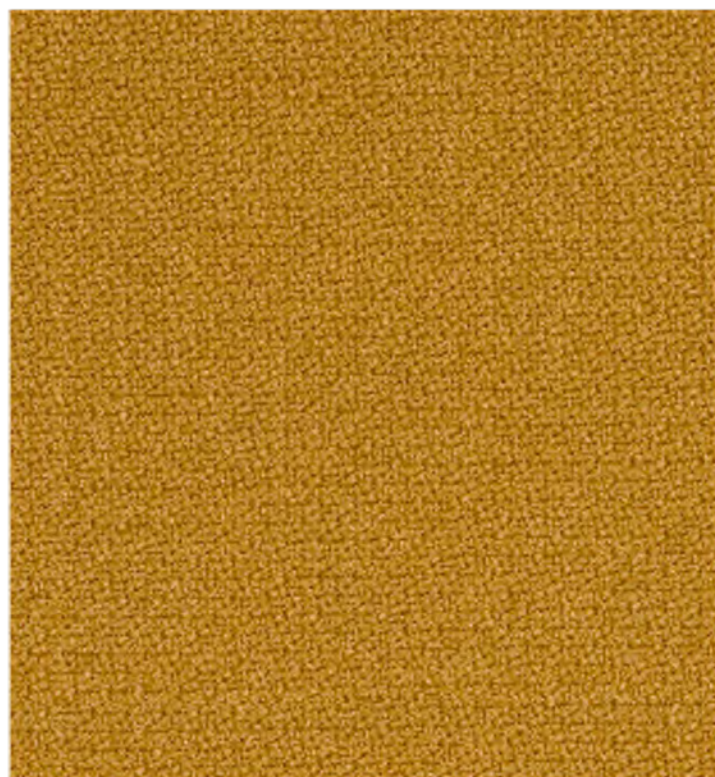

ST08\_Step 62057



ST01\_Step 60999



ST03\_Step 60021



ST04\_Step 60011



ST09\_Step 60004



ST31\_Step 66152



ST30\_Step 67004



ST32\_Step 68161

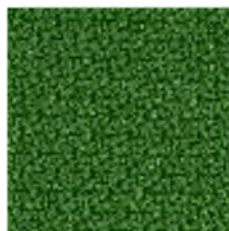

ST12\_Step 68120



ST29\_Step 61103



ST11\_Step 61149



ST08\_Step 62057



ST28\_Step 63075



# Pelli ed ecopelli / Leathers and faux leather / Leder und Kunstleder / Cuir et faux cuir / Cueros y imitación de cuero

SC  
Flukso, Secret



SC18\_Secret 1018



SC17\_Secret 1017



SC24\_Secret 1024



SC36\_Secret 1036



SC01\_Secret 1001

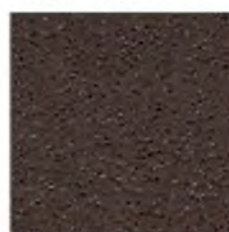

SC06\_Secret 1006



SC26\_Secret 1026



SC18\_Secret 1018



SC25\_Secret 1025



SC31\_Secret 1031



SC33\_Secret 1033



SC08\_Secret 1008



SC19\_Secret 1019



**RG**  
**Camira, Regent**

Cat. 4

100% PL Fr  
50.000 Martindale



RG19\_Regent REG19



RG26\_Regent REG26



RG23\_Regent REG23

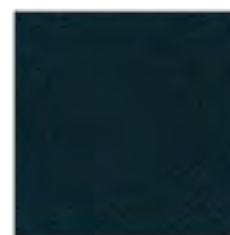

RG22\_Regent REG22



RG25\_Regent REG25



RG15\_Regent REG15



RG11\_Regent REG11

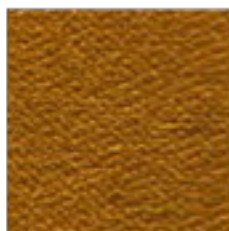

RG10\_Regent REG10



RG07\_Regent REG07



RG05\_Regent REG05



**MW/MF**  
**Camira, Main Line Twist/Main Line Flax**

Cat. 4

75% Virgin Wool, 25% Flax  
50.000 Martindale



MW12\_Main Line Twist MLT12



MF61\_Main Line Flax MLF61



MF26\_Main Line Flax MLF26



MF28\_Main Line Flax MLF28



MF66\_Main Line Flax MLF66



MW14\_Main Line Twist MLT14



MW02\_Main Line Twist MLT02



MF46\_Main Line Flax MLF46



MF17\_Main Line Flax MLF17



MW01\_Main Line Twist MLT01



MW10\_Main Line Twist MLT10



MF59\_Main Line Flax MLF59



MW03\_Main Line Twist MLT03



WF06\_Main Line Flax MLF06



MW04\_Main Line Twist MLT04



MF51\_Main Line Flax MLF51



MF50\_Main Line Flax MLF50



# Tessuti / Fabrics / Gewebe / Tissus / Tejidos

CS  
Gabriel, Crisp



CS08\_Crisp 04033



CS38\_Crisp 04013



CS40\_Crisp 04022



CS08\_Crisp 04033



CS04\_Crisp 04604



CS03\_Crisp 04034



CS35\_Crisp 04572



CS23\_Crisp 04603



CS05\_Crisp 04115



CS07\_Crisp 04032



CS37\_Crisp 04771



CS27\_Crisp 04711



CS05\_Crisp 04301

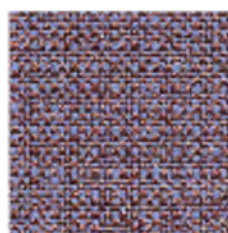

CS26\_Crisp 04702

sitland  
SENAB

**22%** RABATT SKA DRAS AV PÅ ANGIVNA PRISER





# Tessuti / Fabrics / Gewebe / Tissus / Tejidos

SY  
Camira, Synergy

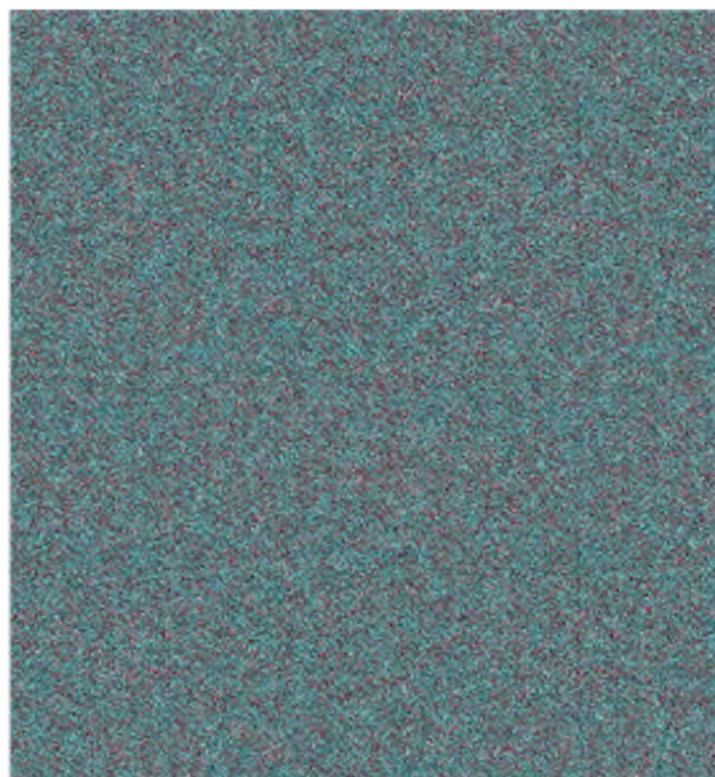

SY09\_Synergy LDS56



SY01\_Synergy LDS27



SY05\_Synergy LDS17

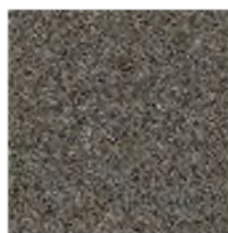

SY04\_Synergy LDS35



SY02\_Synergy LDS08

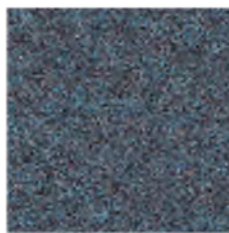

SY07\_Synergy LDS58

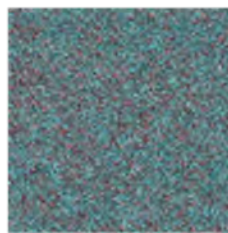

SY09\_Synergy LDS56



SY40\_Synergy LDS54



SY16\_Synergy LDS32



SY46\_Synergy LDS37



SY10\_Synergy LDS83

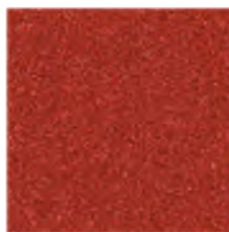

SY13\_Synergy LDS84

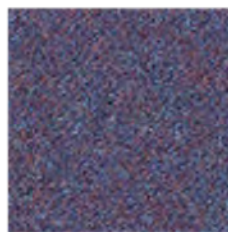

SY32\_Synergy LDS64



**FT**  
**Vescom, Foster**

Cat. 9

97% recycled polyester  
FR / 3% polyester FR  
60.000 Martindale



FT17\_Foster 7072.17



FT14\_Foster 7072.14



FT09\_Foster 7072.09



FT13\_Foster 7072.13



FT02\_Foster 7072.02



FT01\_Foster 7072.01



FT12\_Foster 7072.12





# Tessuti / Fabrics / Gewebe / Tissus / Tejidos

**WI**  
**Vescom, Wilson**

80.000 Martindale  
100% Flame Retardant Polyester



W111\_Wilson 7067.10

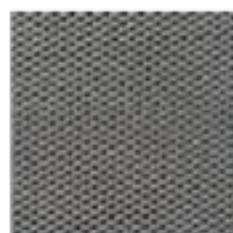

W110\_Wilson 7067.07



W107\_Wilson 7067.06



W108\_Wilson 7067.14



W109\_Wilson 7067.13

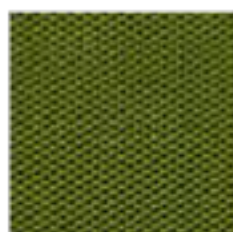

W104\_Wilson 7067.20

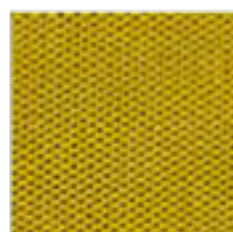

W103\_Wilson 7067.21



W105\_Wilson 7067.04

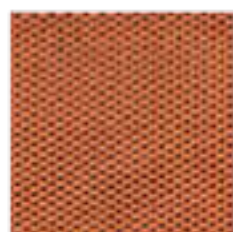

W101\_Wilson 7067.03



W106\_Wilson 7067.01



# Reti / Meshes / Maschen / Mailles / Mallas

IR  
FiDiVi Service, Iron

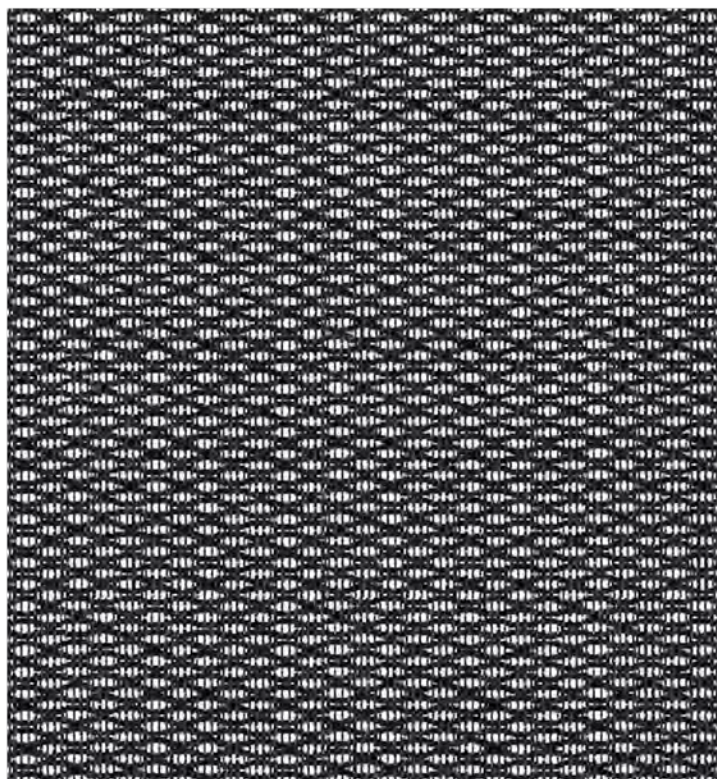

IR01

# Tessuti / Fabrics / Gewebe / Tissus / Tejidos

YO  
Camira, Yoredale



YO03\_Yoredale\_UA02



YO01\_Yoredale\_UA25



YO02\_Yoredale\_UA04



YO09\_Yoredale\_UA17



YO11\_Yoredale\_UA23

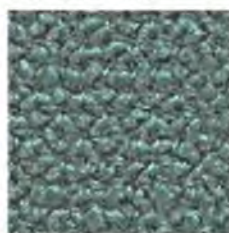

YO10\_Yoredale\_UA22



YO04\_Yoredale\_UA06



YO03\_Yoredale\_UA02



YO07\_Yoredale\_UA05



YO08\_Yoredale\_UA16



YO12\_Yoredale\_UA24



YO06\_Yoredale\_UA12



YO05\_Yoredale\_UA14

sitland  
SENAB

**22%** RABATT SKA DRAS AV PÅ ANGIVNA PRISER



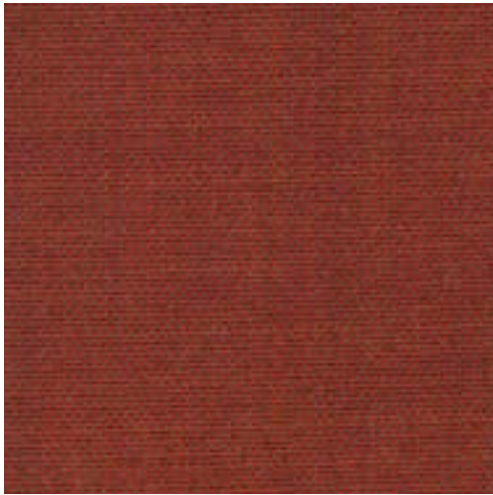

Remix 3 0653

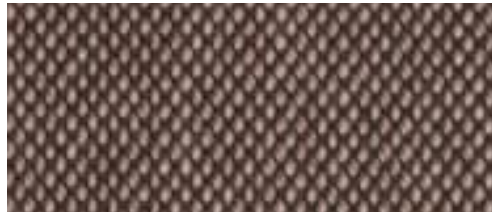

Steelcut Quartet 0354



Steelcut 3 0605



Steelcut Trio 3 0686

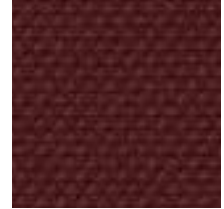

Steelcut 3 0682



Re-Wool 0558

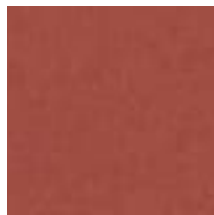

Hero 2 0542



Fiord 2 0571

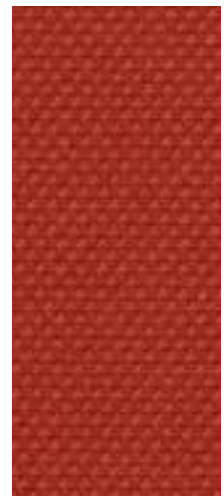

Steelcut 3 0562

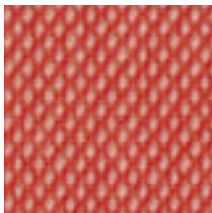

Steelcut Trio 3 0526



Remix 3 0516



Remix 3 0536

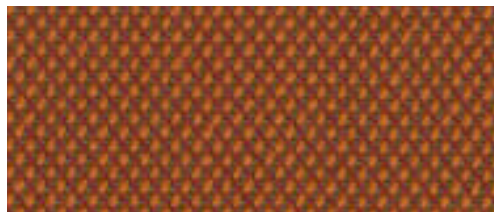

Steelcut Trio 3 0576

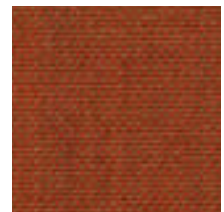

Remix 3 0443

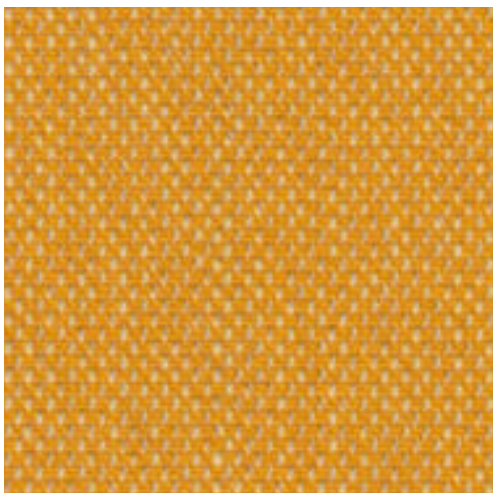

Steelcut Quartet 0434



Steelcut 3 0452



Steelcut Trio 3 0446



Steelcut trio 3 0436

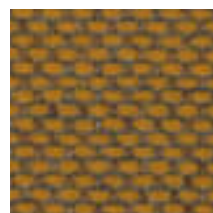

Re-Wool 0448



Fiord 2 0562





Re-Wool 0108



Remix 3 0133

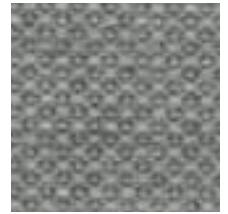

Fiord 2 0151



Steelcut 3 0140

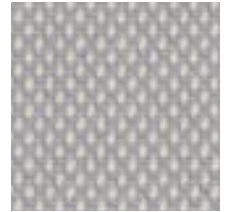

Steelcut Trio 3 0105

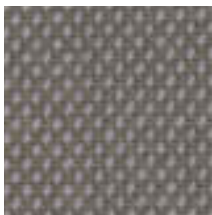

Steelcut Trio 3 0246



Steelcut 3 0155

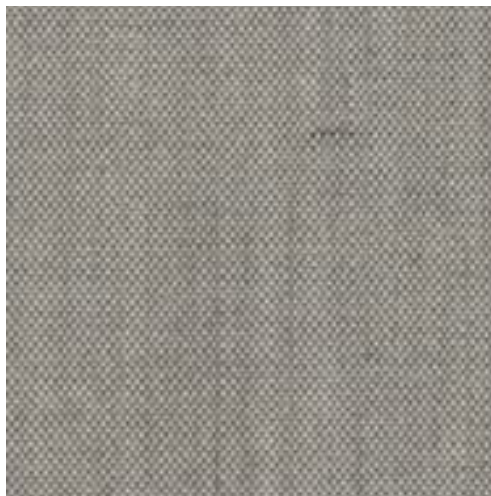

Remix 3 0126



Fiord 2 0101



Steelcut Trio 3 0113



Fiord 2 0251



Steelcut 3 0110



Steelcut Trio 3 0906



Steelcut Trio 3 0236

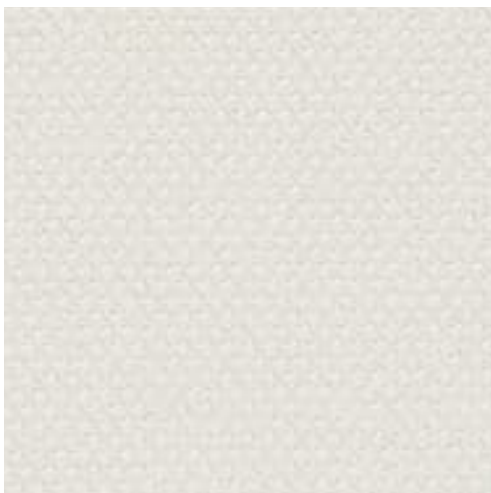

Steelcut 3 0220



Steelcut Quartet 0114



Hero 2 0102



Fiord 2 0322



Steelcut Trio 3 0226



Steelcut Quartet 0414







Remix 3 0773



Fiord 2 0771

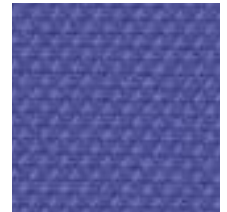

Steelcut 3 0652



Hero 2 0622

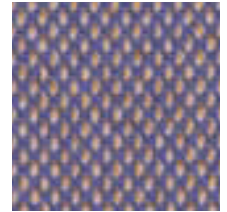

Steelcut Quartet 0644

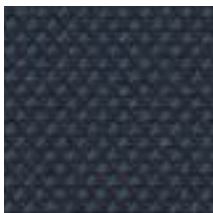

Steelcut Trio 3 0796



Remix 3 0762



Steelcut Trio 3 0746



Remix 3 0866

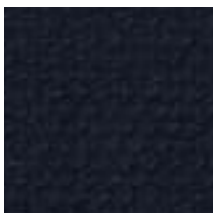

Steelcut 3 0775



Hero 2 0752

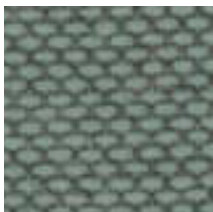

Re-Wool 0858

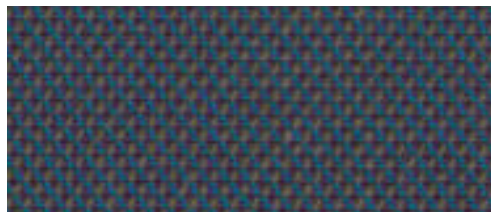

Steelcut Trio 3 0883



Hero 2 0772



Hero 2 0932



Steelcut Trio 3 0996

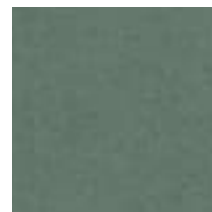

Steelcut 3 0932



Steelcut 3 0180



Remix 3 0982



Steelcut 3 0190



# Pelli ed ecopelli / Leathers and faux leather / Leder und Kunstleder / Cuir et faux cuir / Cueros y imitación de cuero

SX  
Dani, Box Land



SX05\_Box Land 7763



SX01\_Box Land 7150



SX02\_Box Land 7110



SX05\_Box Land 7763

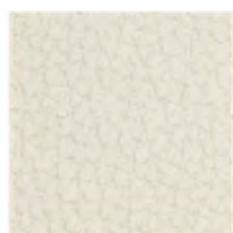

SX04\_Box Land 7200



SX03\_Box Land 7160

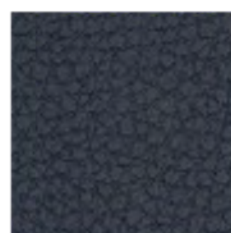

SX12\_Box Land 7190

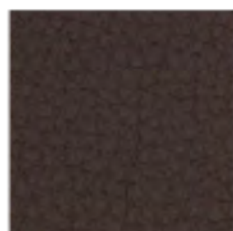

SX10\_Box Land 7270



SX09\_Box Land 7748



SX08\_Box Land 7250

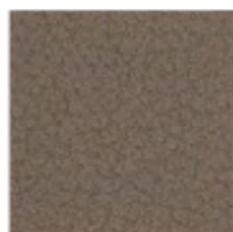

SX07\_Box Land 7799

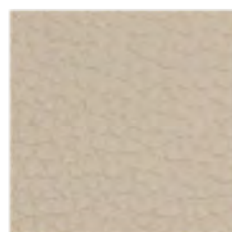

SX06\_Box Land 7734

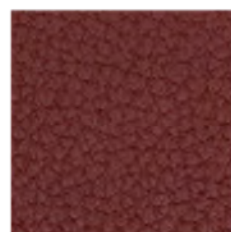

SX11\_Box Land 7170





# Pelli ed ecopelli / Leathers and faux leather / Leder und Kunstleder / Cuir et faux cuir / Cueros y imitación de cuero

PA  
Dani, Panama

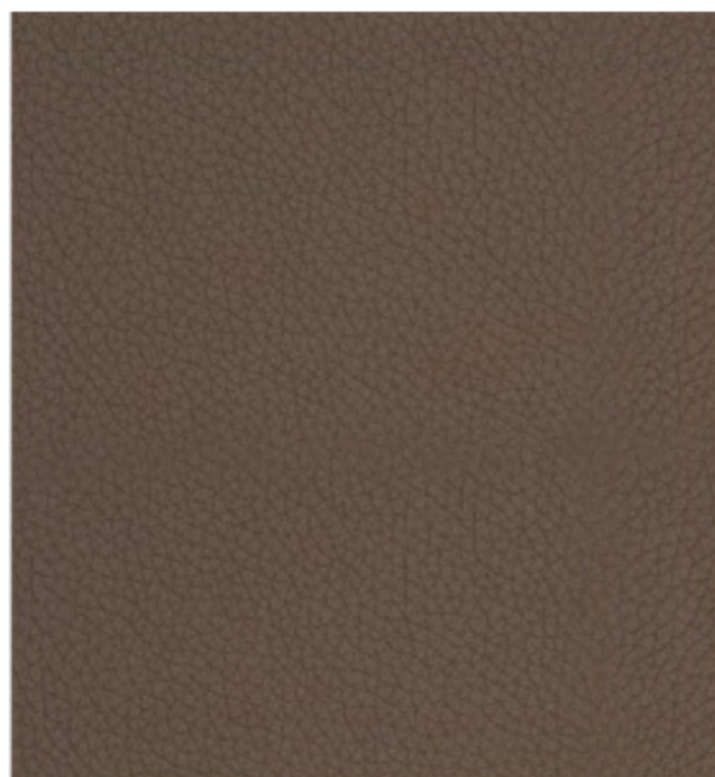

PA03\_Panama 5522

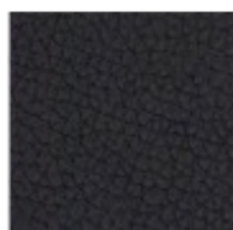

PA08\_Panama 5300



PA09\_Panama 5290



PA07\_Panama 5402



PA02\_Panama 5000

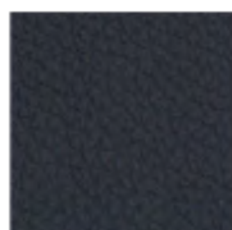

PA12\_Panama 5260

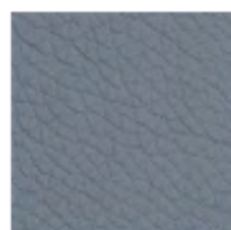

PA10\_Panama 5416

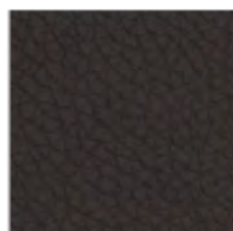

PA06\_Panama 5270

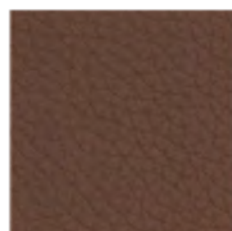

PA05\_Panama 5090

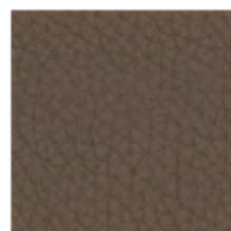

PA03\_Panama 5522

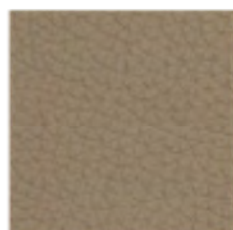

PA04\_Panama 5320

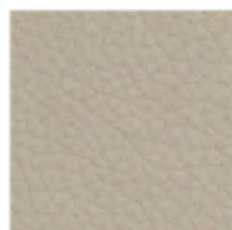

PA13\_Panama 5528

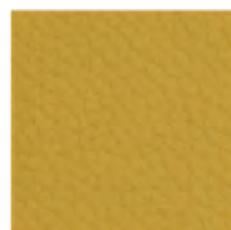

PA14\_Panama 5430

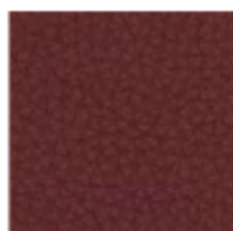

PA11\_Panama 5210



# Pelli ed ecopelli / Leathers and faux leather / Leder und Kunstleder / Cuir et faux cuir / Cueros y imitación de cuero

TS  
Dani, Florida



TS36\_Florida 2004

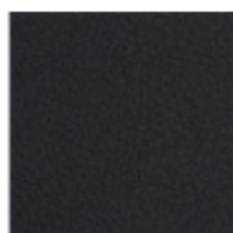

TS01\_Florida 2002

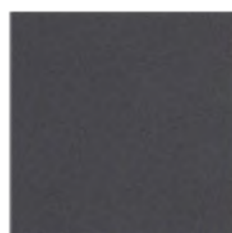

TS13\_Florida 2076

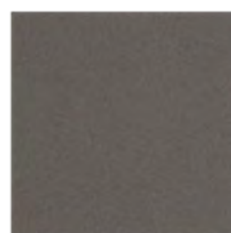

TS36\_Florida 2258



TS33\_Florida 2128



TS15\_Florida 2052

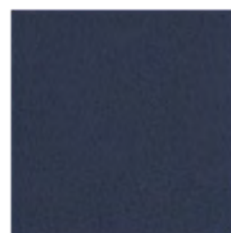

TS11\_Florida 2008

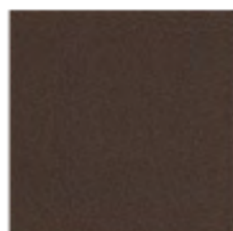

TS07\_Florida 2062

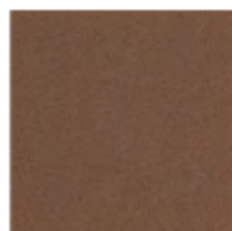

TS22\_Florida 2064

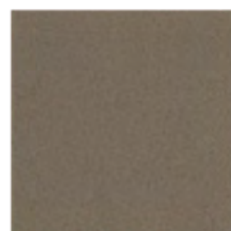

TS24\_Florida 2176



TS36\_Florida 2004



TS05\_Florida 2024

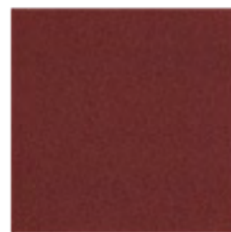

TS02\_Florida 2120

