

22% rabatt ska dras av på angivna priser
OBS. Prislista inkl. moms



A - Arbetsplats och förvaring

HAY





Våra kontor

Borlänge

Borganäsvägen 16
784 33 Borlänge
+46 (0)243 882 70
borlange@inputinterior.se

Borås

Olovsholmsgatan 25
506 34 Borås
+46 (0)33 21 11 00
boras@inputinterior.se

Göteborg

Fältpatsgatan 2
421 30 Västra Frölunda
+46 (0)31 799 89 00
goteborg@inputinterior.se

Halmstad

Svartalundsvägen 6
302 35 Halmstad
+46 (0)35 295 85 00
halmstad@inputinterior.se

Helsingborg

Muskötgatan 4B
254 66 Helsingborg
+46 (0)42 444 96 30
helsingborg@inputinterior.se

Jönköping

Huskvarnavägen 64
554 54 Jönköping
+46 (0)36 585 95 30
jonkoping@inputinterior.se

Kalmar

Engelska vägen 5
392 39 Kalmar
+46 (0)480 578 00
kalmar@inputinterior.se

Karlskrona

Blekingegatan 6A
371 34 Karlskrona
+46 (0)455 68 88 20
karlskrona@inputinterior.se

Karlstad

Blockgatan 10
653 41 Karlstad
+46 (0)54 775 66 60
karlstad@inputinterior.se

Kinna

Boråsvägen 17
511 56 Kinna
+46 (0)320 20 90 30
kinna@inputinterior.se

Kristianstad

Västra Storgatan 51K
291 31 Kristianstad
+46 (0)44 785 08 40
kristianstad@inputinterior.se

Linköping

Gottorpsgatan 57
581 19 Linköping
+46 (0)13 36 44 50
linkoping@inputinterior.se

Luleå

Bangårdsgatan 14
972 75 Luleå
+46 (0)920 46 64 30
lulea@inputinterior.se

Malmö

Flygplansgatan 9
212 39 Malmö
+46 (0)40 20 66 00
malmo@inputinterior.se

Norrköping

Västgötegatan 13B
602 21 Norrköping
+46 (0)11 440 94 00
norrkoping@inputinterior.se

Skellefteå

Brogatan 3
931 62 Skellefteå
+46 (0)910 48 84 60
skelleftea@inputinterior.se

Skövde

Gustav Adolfs gata 31
541 45 Skövde
+46 (0)500 77 93 80
skovde@inputinterior.se

Stockholm

Sveavägen 145
113 46 Stockholm
+46 (0)8 517 112 00
stockholm@inputinterior.se

Sundsvall

Strandgatan 14
852 31 Sundsvall
+46 (0)60 52 50 10
sundsvall@inputinterior.se

Uppsala

Sjukhusvägen 3
753 09 Uppsala
+46 (0)18 430 53 04
upsala@inputinterior.se

Umeå

Björnvägen 19
906 40 Umeå
+46 (0)90 34 00 160
umea@inputinterior.se

Västerås

Metallverksgatan 4B
721 30 Västerås
+46 (0)21 80 30 30
vasteras@inputinterior.se

Växjö

Södra Vallviksvägen 10
352 51 Växjö
+46 (0)470 79 37 00
vaxjo@inputinterior.se

Örebro

Radiatorvägen 2
702 27 Örebro
+46 (0)19 767 35 80
orebro@inputinterior.se

Norden

Se inputinterior.se för
våra kontor i Danmark,
Finland och Norge.

22% rabatt ska dras av på angivna priser
OBS. Prislista inkl. moms

SHELF TOP | 34 | 100 | 150

23 mm shelf. Powder coated extruded aluminium. End parts in die cast aluminium.
Please note that wall- or floor safety brackets are needed above a certain height.
Please see the New Order instruction manuals for further information or contact our sales team.

Stock item

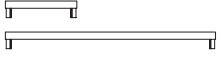

MATERIAL	COLOUR			
	Army	Charcoal	Light grey	Red
Powder coated extruded aluminium	•	•	•	•

VARIANT	DIMENSION	BOX DIMENSION WEIGHT	PACKAGING	PRICE
W34	W34 x D34 x H2,3 W13.39" x D13.39" x H0.91"	1 pcs. W39 x D39.5 x H10.5 2.31 kg	1 box 1 pcs.	1.130,00
W100	W100 x D34 x H2,3 W39.37" x D13.39" x H0.91"	1 pcs. W105 x D39.5 x H10.5 6.4 kg	1 box 1 pcs.	2.120,00
W150	W150 x D34 x H2,3 W59.06" x D13.39" x H0.91"	1 pcs. W155 x D39.5 x H10.5 9.1 kg	1 box 1 pcs.	3.050,00

SHELF MIDDLE | 34 | 100 | 150

23 mm shelf. Powder coated extruded aluminium. End parts in die cast aluminium.
Please note that wall- or floor safety brackets are needed above a certain height.
Please see the New Order instruction manuals for further information or contact our sales team.

Stock item

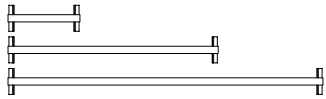

MATERIAL	COLOUR			
	Army	Charcoal	Light grey	Red
Powder coated extruded aluminium	•	•	•	•

VARIANT	DIMENSION	BOX DIMENSION WEIGHT	PACKAGING	PRICE
W34	W34 x D34 x H2,3 W13.39" x D13.39" x H0.91"	1 pcs. W39 x D39.5 x H14 2.46 kg	1 box 1 pcs.	1.130,00
W100	W100 x D34 x H2,3 W39.37" x D13.39" x H0.91"	1 pcs. W105 x D39.5 x H14 6.63 kg	1 box 1 pcs.	2.120,00
W150	W150 x D34 x H2,3 W59.06" x D13.39" x H0.91"	1 pcs. W155 x D39.5 x H14 9.18 kg	1 box 1 pcs.	3.050,00

SHELF BOTTOM | 34 | 100 | 150

23 mm shelf. Powder coated extruded aluminium. End parts in die cast aluminium.
Incl. adjustable feet. Please note that wall- or floor safety brackets are needed above a certain height.
Please see the New Order instruction manuals for further information or contact our sales team.

Stock item

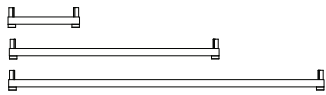

MATERIAL	COLOUR			
	Army	Charcoal	Light grey	Red
Powder coated extruded aluminium	•	•	•	•

VARIANT	DIMENSION	BOX DIMENSION WEIGHT	PACKAGING	PRICE
W34	W34 x D34 x H2,3 W13.39" x D13.39" x H0.91"	1 pcs. W39 x D39.5 x H10.5 2.42 kg	1 box 1 pcs.	1.130,00
W100	W100 x D34 x H2,3 W39.37" x D13.39" x H0.91"	1 pcs. W105 x D39.5 x H10.5 6.21 kg	1 box 1 pcs.	2.120,00
W150	W150 x D34 x H2,3 W59.06" x D13.39" x H0.91"	1 pcs. W155 x D39.5 x H10.5 9 kg	1 box 1 pcs.	3.050,00

22% rabatt ska dras av på angivna priser OBS. Prislista inkl. moms

SINGLE PROFILE | SET OF 4

Powder coated extruded aluminium. Incl. Premounted set screws. Single or double height.

Stock item

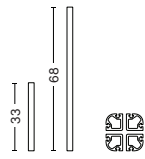

VARIANT	DIMENSION	BOX DIMENSION WEIGHT	PACKAGING	PRICE	MATERIAL	
					COLOUR	
H33	W2,2 x D2,2 x H33 W0.87" x D0.87" x H12.99"	1 pcs. W34.5 x D5.5 x H5.5 0.87 kg	1 box 1 pcs.	490,00	Powder coated extruded aluminium	Army Charcoal Light grey Red
H68	W2,2 x D2,2 x H68 W0.87" x D0.87" x H26.77"	1 pcs. W70 x D5.5 x H5.5 1.8 kg	1 box 1 pcs.	900,00		

DOUBLE PROFILE | SET OF 2

Powder coated extruded aluminium. Incl. premounted set screws. Single or double height.

Stock item

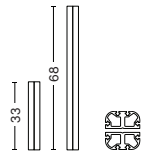

VARIANT	DIMENSION	BOX DIMENSION WEIGHT	PACKAGING	PRICE	MATERIAL	
					COLOUR	
H33	W2,2 x D2,2 x H33 W0.87" x D0.87" x H12.99"	1 pcs. W34.5 x D5.5 x H5.5 0.87 kg	1 box 1 pcs.	490,00	Powder coated extruded aluminium	Army Charcoal Light grey Red
H68	W2,2 x D2,2 x H68 W0.87" x D0.87" x H26.77"	1 pcs. W70 x D5.5 x H5.5 1.8 kg	1 box 1 pcs.	900,00		

CORNER PROFILE | SET OF 1 + 1

Powder coated extruded aluminium. Incl. Premounted set screws. Single or double height.

Set of 1 x single + 1 x triple.

Stock item

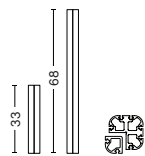

VARIANT	DIMENSION	BOX DIMENSION WEIGHT	PACKAGING	PRICE	MATERIAL	
					COLOUR	
H33	W2,2 x D2,2 x H33 W0.87" x D0.87" x H12.99"	1 pcs. W34.5 x D5.5 x H5.5 0.87 kg	1 box 1 pcs.	490,00	Powder coated extruded aluminium	Army Charcoal Light grey Red
H68	W2,2 x D2,2 x H68 W0.87" x D0.87" x H26.77"	1 pcs. W70 x D5.5 x H5.5 1.8 kg	1 box 1 pcs.	900,00		

22% rabatt ska dras av på angivna priser OBS. Prislista inkl. moms

BENCHTOP | 34 | 100 | 150

MDF board with foam top upholstered with fabric or leather. Premounted with velcro for mounting. Please note shelving below benchtop should be open without panels, drawers or doors.

Order produced

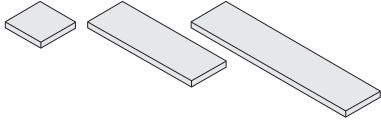

VARIANT	DIMENSION	BOX DIMENSION WEIGHT	PACKAGING	FABRIC	PRICE
	W34 x D34 x H2,3 W13.39" x D13.39" x H0.91"	1 pcs. W39 x D36 x H30 2 kg	1 box 1 pcs.	Remix Surface By HAY Steelcut Steelcut Trio Canvas Sierra Black Sense Cognac	1.180,00 1.180,00 1.250,00 1.250,00 1.330,00 1.730,00 2.200,00

VARIANT	DIMENSION	BOX DIMENSION WEIGHT	PACKAGING	FABRIC	PRICE
	W100 x D34 x H2,3 W39.37" x D13.39" x H0.91"	1 pcs. W105 x D36 x H5 3 kg	1 box 1 pcs.	Remix Surface By HAY Steelcut Steelcut Trio Canvas Sierra Black Sense Cognac	2.350,00 2.350,00 2.500,00 2.500,00 2.660,00 3.300,00 4.070,00

VARIANT	DIMENSION	BOX DIMENSION WEIGHT	PACKAGING	FABRIC	PRICE
	W150 x D34 x H2,3 W59.06" x D13.39" x H0.91"	1 pcs. W155 x D36 x H5 3.5 kg	1 box 1 pcs.	Remix Surface By HAY Steelcut Steelcut Trio Canvas Sierra Black Sense Cognac	3.370,00 3.370,00 3.600,00 3.600,00 3.850,00 4.850,00 6.100,00

22% rabatt ska dras av på angivna priser
OBS. Prislista inkl. moms

WOODEN PANELS AND DOOR | 100 | 150

Set of doors and panels. 6 mm MDF with front and back veneer. 100 cm | Set of 1 sliding door, 2 side panels and 1 back panel. Opening right. 150 cm | Set of 2 doors, 2 sides panels and 1 back panel. Opening right and left. Incl. handle in Army, Light Grey or Charcoal. Please note that wooden panels and doors are not suitable for hard contract use.

Order produced

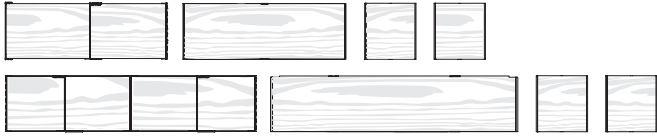

FINISH	SIZE	
	W100	W150
Untreated oak veneer	•	•
Untreated ash veneer	•	•

VARIANT	DIMENSION	BOX DIMENSION WEIGHT	PACKAGING	PRICE
W100	DOOR 100 W95,5 x D0,7 x H33 cm W37.6" x D0.28" x H12.99"	W108,5 x D43 x H4,2 cm 7,50 kg	1 box 1 pcs.	3.130,00
	BACK PANEL 100 W95 x D0,7 x H33 cm W37.40" x D0.28" x H12.99"			
	SIDE PANEL W29,5 x D0,7 x H33 cm W11.61" x D0.28" x H12.99"			

VARIANT	DIMENSION	BOX DIMENSION WEIGHT	PACKAGING	PRICE
W150	DOOR 150 W145,5 x D0,7 x H33 cm W57.29" x D0.28" x H12.99"	W163,50 x D45 x H4,2 cm 10 kg	1 box 1 pcs.	6.300,00
	BACK PANEL 150 W145 x D0,7 x H33 cm W57.09" x D0.28" x H12.99"			
	SIDE PANEL W29,5 x D0,7 x H33 cm W11.61" x D0.28" x H12.99"			

WOODEN PANELS AND DOOR | 100 LEFT

6 mm MDF with front and back veneer. Set of 1 sliding door, 2 side panels and 1 back panel. Opening Left. Incl. handle in Army, Light Grey or Charcoal. Please note that wooden panels and doors are not suitable for hard contract use.

Order produced



FINISH	SIZE	
	W100	
Untreated oak veneer	•	
Untreated ash veneer	•	

VARIANT	DIMENSION	BOX DIMENSION WEIGHT	PACKAGING	PRICE
W100	DOOR 100 W95,5 x D0,7 x H33 cm W37.6" x D0.28" x H12.99"	W108,5 x D43 x H4,2 cm 7,50 kg	1 box 1 pcs.	3.130,00
	BACK PANEL 100 W95 x D0,7 x H33 cm W37.40" x D0.28" x H12.99"			
	SIDE PANEL W29,5 x D0,7 x H33 cm W11.61" x D0.28" x H12.99"			

22% rabatt ska dras av på angivna priser
OBS. Prislista inkl. moms

WOODEN WALL PANELS AND DOOR | 100 | 150

Set of doors and panels. 6 mm MDF with front and back veneer.
 100 cm | Set of 1 sliding door, 2 side panels and 1 wall panel. Opening right. 150 cm | Set of 2 doors, 2 sides panels and 1 wall panel. Opening right and left. Incl. handle in Army, Light Grey or Charcoal. Wall brackets are sold separately. Please note that wooden panels and doors are not suitable for hard contract use.

Order produced

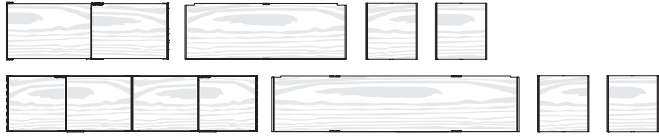

FINISH	SIZE	
	W100	W150
Untreated oak veneer	•	•
Untreated ash veneer	•	•

VARIANT	DIMENSION	BOX DIMENSION WEIGHT	PACKAGING	PRICE
W100	DOOR 100 W95,5 x D0,7 x H33 cm W37.6" x D0.28" x H12.99"	W108,5 x D43 x H4,2 cm 7,50 kg	1 box 1 pcs.	3.300,00
	BACK PANELI 100 W95 x D0,7 x H33 cm W37.40" x D0.28" x H12.99"			
	SIDE PANEL W29,5 x D0,7 x H33 cm W11.61" x D0.28" x H12.99"			

VARIANT	DIMENSION	BOX DIMENSION WEIGHT	PACKAGING	PRICE
W150	DOOR 150 W145,5 x D0,7 x H33 cm W57.29" x D0.28" x H12.99"	W163,50 x D45 x H4,2 cm 10 kg	1 box 1 pcs.	6.400,00
	BACK PANEL 150 W145 x D0,7 x H33 cm W57.09" x D0.28" x H12.99"			
	SIDE PANEL W29,5 x D0,7 x H33 cm W11.61" x D0.28" x H12.99"			

WOODEN WALL PANELS AND DOOR | 100 LEFT

Set of doors and panels. 6 mm MDF with front and back veneer.
 Set of 1 sliding door, 2 side panels and 1 wall panel. Opening Left. Incl. handle in Army, Light Grey or Charcoal. Wall brackets are sold separately. Please note that wooden panels and doors are not suitable for hard contract use.

Order produced



FINISH	SIZE	
	W100	
Untreated oak veneer	•	
Untreated ash veneer	•	

VARIANT	DIMENSION	BOX DIMENSION WEIGHT	PACKAGING	PRICE
W100	DOOR 100 W95,5 x D0,7 x H33 cm W37.6" x D0.28" x H12.99"	W108,5 x D43 x H4,2 cm 7,50 kg	1 box 1 pcs.	3.300,00
	BACK PANELI 100 W95 x D0,7 x H33 cm W37.40" x D0.28" x H12.99"			
	SIDE PANEL W29,5 x D0,7 x H33 cm W11.61" x D0.28" x H12.99"			

22% rabatt ska dras av på angivna priser
OBS. Pristista inkl. moms

STEEL SIDE PANEL | 34

STEEL SIDE PANEL DOUBLE HEIGHT 34

Powder coated steel.

Order produced

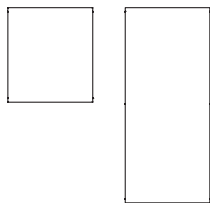

MATERIAL	COLOUR		
	Army	Charcoal	Light grey
Powder coated steel	•	•	•

VARIANT	DIMENSION	BOX DIMENSION WEIGHT	PACKAGING	PRICE
H33	W29,5 x D1,6 x H33 W11.61" x D0.63" x H12.99"	1 pcs. W29.5 x D1.6 x H33 1.5 kg	1 box 1 pcs.	500,00
H68	W29,5 x D1,6 x H68 W11.61" x D0.63" x H26.77"	1 pcs. W29.5 x D1.6 x H68 3 kg	1 box 1 pcs.	790,00

STEEL SIDE PANEL DOUBLE HEIGHT FOR ADJUSTABLE SHELF | 34

Powder coated steel. Adjustable shelves are ordered separately.

Order produced

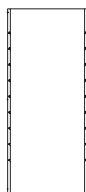

MATERIAL	COLOUR		
	Army	Charcoal	Light grey
Powder coated steel	•	•	•

VARIANT	DIMENSION	BOX DIMENSION WEIGHT	PACKAGING	PRICE
W100	W95,5 x D34 x H2,2 W37.60" x D13.39" x H0.87"	1 pcs. W95.5 x D34 x H2.2 4.5 kg	1 box 1 pcs.	940,00

STEEL SHELF FOR ADJUSTABLE PANELS | 100

1,25 mm shelf in powder coated steel. Incl. 4 pins in POM.

Order produced

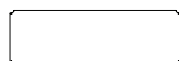

MATERIAL	COLOUR		
	Army	Charcoal	Light grey
Powder coated steel	•	•	•

VARIANT	DIMENSION	BOX DIMENSION WEIGHT	PACKAGING	PRICE
	W95,5 x D34 x H2,2 W37.60" x D13.39" x H0.87"	1 pcs. W95.5 x D34 x H2.2 4.5 kg	1 box 1 pcs.	940,00

PINS FOR ADJUSTABLE SHELF | SET OF 4

Set of 4 pins in POM

Order produced



MATERIAL	COLOUR		
	Army	Charcoal	Light grey
POM	•	•	•

VARIANT	DIMENSION	BOX DIMENSION WEIGHT	PACKAGING	PRICE
SET OF 4	W5 x D5 x H1 W1.97" x D1.97" x H0.39"	1 pcs. W5 x D5 x H1 0.04 kg	1 box 1 pcs.	130,00

22% rabatt ska dras av på angivna priser
OBS. Prislista inkl. moms

STEEL BACK PANEL | 100 | 150

Powder coated steel.

Order produced



MATERIAL	COLOUR
Powder coated steel	Army Charcoal Light grey

VARIANT	DIMENSION	BOX DIMENSION WEIGHT	PACKAGING	PRICE
W100	W95,5 x D1,6 x H33 W37.60" x D0.63" x H12.99"	1 pcs. W95.5 x D1.6 x H33 4.5 kg	1 box 1 pcs.	790,00
W150	W145,5 x D1,6 x H33 W57.28" x D0.63" x H12.99"	1 pcs. W145.5 x D1.6 x H33 7 kg	1 box 1 pcs.	1.570,00

STEEL BACK PANEL DOUBLE HEIGHT | 100

Powder coated steel

Order produced



MATERIAL	COLOUR
Powder coated steel	Army Charcoal Light grey

VARIANT	DIMENSION	BOX DIMENSION WEIGHT	PACKAGING	PRICE
W100	W95,5 x D1,6 x H68 W37.60" x D0.63" x H26.77"	1 pcs. W95.5 x D1.6 x H68 9 kg	1 box 1 pcs.	1.250,00

STEEL WALL BACK PANEL | 100 | 150

Powder coated steel. With cutouts for wall brackets.

Order produced



MATERIAL	COLOUR
Powder coated steel	Army Charcoal Light grey

VARIANT	DIMENSION	BOX DIMENSION WEIGHT	PACKAGING	PRICE
W100	W95,5 x D1,6 x H33 W37.60" x D0.63" x H12.99"	1 pcs. W95.5 x D1.6 x H33 4.5 kg	1 box 1 pcs.	940,00
W150	W145,5 x D1,6 x H33 W57.28" x D0.63" x H12.99"	1 pcs. W145.5 x D1.6 x H33 7 kg	1 box 1 pcs.	1.730,00

STEEL WALL BACK PANEL DOUBLE HEIGHT | 100

Powder coated steel.

Order produced



MATERIAL	COLOUR
Powder coated steel	Army Charcoal Light grey

VARIANT	DIMENSION	BOX DIMENSION WEIGHT	PACKAGING	PRICE
H68	W95,5 x D1,6 x H68 cm W37.60" x D0.63" x H26.77"	W95,5 x D1,6 x H68 cm 9 kg	1 box 1 pcs.	1.400,00

22% rabatt ska dras av på angivna priser
OBS. Pristista inkl. moms

STEEL TABLE PANEL | 34

STEEL TABLE PANEL DOUBLE HEIGHT | 34

Powder coated steel. Used under the tables when connecting tables with shelf or tray units. Incl. cutout for cables.

Order produced

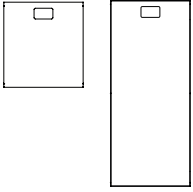

MATERIAL	COLOUR		
	Army	Charcoal	Light grey
Powder coated steel	•	•	•

VARIANT	DIMENSION	BOX DIMENSION WEIGHT	PACKAGING	PRICE
H32	W29,5 x D1,6 x H32 W11.61" x D0.63" x H12.60"	1 pcs. W29.5 x D1.6 x H32 1.5 kg	1 box 1 pcs.	630,00
H67	W29,5 x D1,6 x H67 W11.61" x D0.63" x H26.38"	1 pcs. W29.5 x D1.6 x H67 3 kg	1 box 1 pcs.	1.100,00

STEEL TABLE PANEL DOUBLE HEIGHT FOR ADJUSTABLE SHELF | 34

Powder coated steel. Used under the tables when connecting tables with shelf or tray units. Incl. cutout for cables.

Order produced



MATERIAL	COLOUR		
	Army	Charcoal	Light grey
Powder coated steel	•	•	•

VARIANT	DIMENSION	BOX DIMENSION WEIGHT	PACKAGING	PRICE
H67	W29,5 x D1,6 x H67 W11.61" x D0.63" x H26.38"	1 pcs. W29.5 x D1.6 x H67 3 kg	1 box 1 pcs.	940,00

STEEL TABLE BACK PANEL | 100 | 150

Powder coated steel. Used under the tables when connecting tables with shelf or tray units. Incl. cutout for cables.

Order produced



MATERIAL	COLOUR		
	Army	Charcoal	Light grey
Powder coated steel	•	•	•

VARIANT	DIMENSION	BOX DIMENSION WEIGHT	PACKAGING	PRICE
W100	W95,5 x D1,6 x H33 W37.60" x D0.63" x H12.99"	1 pcs. W95.5 x D1.6 x H33 4.5 kg	1 box 1 pcs.	940,00
W150	W145,5 x D1,6 x H33 W57.28" x D0.63" x H12.99"	1 pcs. W145.5 x D1.6 x H33 7 kg	1 box 1 pcs.	1.730,00

22% rabatt ska dras av på angivna priser
OBS. Prislista inkl. moms

STEEL TABLE BACK PANEL DOUBLE HEIGHT | 100

Powder coated steel. Used under the tables when connecting tables with shelf or tray units. Incl. cutout for cables.

Order produced

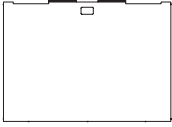

MATERIAL	COLOUR		
	Army	Charcoal	Light grey
Powder coated steel	•	•	•

VARIANT	DIMENSION	BOX DIMENSION WEIGHT	PACKAGING	PRICE
W100	W95,5 x D1,6 x H68 W37.60" x D0.63" x H26.77"	1 pcs. W95.5 x D1.6 x H68 9 kg	1 box 1 pcs.	1.400,00

STEEL PERFORATED BACK PANEL | 100 | 150

Powder coated steel

Order produced

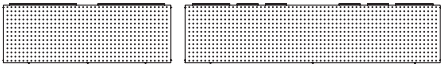

MATERIAL	COLOUR		
	Army	Charcoal	Light grey
Powder coated steel	•	•	•

VARIANT	DIMENSION	BOX DIMENSION WEIGHT	PACKAGING	PRICE
W100	W95,5 x D1,6 x H33 W37.60" x D0.63" x H12.99"	1 pcs. W95.5 x D1.6 x H33 4.5 kg	1 box 1 pcs.	1.400,00
W150	W145,5 x D1,6 x H33 W57.28" x D0.63" x H12.99"	1 pcs. W145.5 x D1.6 x H33 7 kg	1 box 1 pcs.	2.350,00

STEEL PERFORATED BACK PANEL DOUBLE HEIGHT | 100

Powder coated steel.

Order produced



MATERIAL	COLOUR		
	Army	Charcoal	Light grey
Powder coated steel	•	•	•

VARIANT	DIMENSION	BOX DIMENSION WEIGHT	PACKAGING	PRICE
W100	W95,5 x D1,6 x H68 W37.60" x D0.63" x H26.77"	1 pcs. W95.5 x D1.6 x H68 9 kg	1 box 1 pcs.	2.200,00

22% rabatt ska dras av på angivna priser
OBS. Prislista inkl. moms

MOUNTING ADAPTER TRAY

Plastic

Stock item

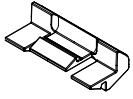

MATERIAL	COLOUR
Plastic	Army
	Charcoal
	Light grey

VARIANT	DIMENSION	BOX DIMENSION WEIGHT	PACKAGING	PRICE
PLASTIC	W4 x D1 x H1 W1.57" x D0.39" x H0.39"	1 pcs. W5 x D1 x H1 0.02 kg	1 box 1 pcs.	49,00

BACK PANEL FASTENER ADAPTER TRAY

Plastic

Stock item

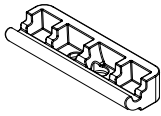

MATERIAL	COLOUR
Plastic	Army
	Charcoal
	Light grey

VARIANT	DIMENSION	BOX DIMENSION WEIGHT	PACKAGING	PRICE
PLASTIC	W4 x D1 x H1 W1.57" x D0.39" x H0.39"	1 pcs. W4 x D1 x H1 0.02 kg	1 box 1 pcs.	49,00

22% rabatt ska dras av på angivna priser
OBS. Prislista inkl. moms

TEXTILE PANEL | 34 | 100 | 150

A foam-filled textile panel insert is mounted with fixed velcro onto a powder coated steel cover used on the outside or inside of the shelving. Textile on one side. Steel cover in army, charcoal or light grey.

Order produced

VARIANT	DIMENSION	BOX DIMENSION WEIGHT	PACKAGING	FABRIC	PRICE	COVER	
						COLOUR	Army Charcoal Light grey
						Powder coated steel	• • •
W34	W29,5 x D1,6 x H68 cm W11.61" x D0.63" x H26.77"	W29,5 x D1,6 x H33 cm 1,50 kg W29 x D1 x H32,5 cm 0,20 kg	1 box 1 pcs.	Remix Surface By HAY Steelcut Steelcut Trio Canvas	1.730,00 1.730,00 1.960,00 1.960,00 2.030,00		
W100	W95,5 x D1,6 x H33 cm W37.6" x D0.63" x H12.99"	W95,5 x D1,6 x H33 cm 4,5 kg W95 x D1 x H32,5 cm 0,80 kg	1 box 1 pcs.	Remix Surface By HAY Steelcut Steelcut Trio Canvas	2.990,00 2.990,00 3.440,00 3.440,00 3.600,00		
W150	W145,5 x D1,6 x H33 cm W57.28" x D0.637" x H12.99"	W145,5 x D1,6 x H33 cm 7 kg W145 x D1 x H32,5 cm 1,20 kg	1 box 1 pcs.	Remix Surface By HAY Steelcut Steelcut Trio Canvas	4.390,00 4.390,00 5.030,00 5.030,00 5.260,00		

INSIDE TEXTILE PANEL | 34 | 100 | 150

A foam-filled textile panel insert is mounted with fixed velcro onto a powder coated steel cover used on the outside or inside of the shelving. Textile on one side. Steel cover in army, charcoal or light grey.

Order produced

VARIANT	DIMENSION	BOX DIMENSION WEIGHT	PACKAGING	FABRIC	PRICE	COVER	
						COLOUR	Army Charcoal Light grey
						Powder coated steel	• • •
W34	W29,5 x D1,6 x H68 cm W11.61" x D0.63" x H26.77"	W29,5 x D1,6 x H33 cm 1,50 kg W29 x D1 x H32,5 cm 0,20 kg	1 box 1 pcs.	Remix Surface By HAY Steelcut Steelcut Trio Canvas	1.600,00 1.600,00 1.830,00 1.830,00 1.900,00		
W100	W95,5 x D1,6 x H33 cm W37.6" x D0.63" x H12.99"	W95,5 x D1,6 x H33 cm 4,5 kg W95 x D1 x H32,5 cm 0,80 kg	1 box 1 pcs.	Remix Surface By HAY Steelcut Steelcut Trio Canvas	2.840,00 2.840,00 3.290,00 3.290,00 3.450,00		
W150	W145,5 x D1,6 x H33 cm W57.28" x D0.637" x H12.99"	W145,5 x D1,6 x H33 cm 7 kg W145 x D1 x H32,5 cm 1,20 kg	1 box 1 pcs.	Remix Surface By HAY Steelcut Steelcut Trio Canvas	4.230,00 4.230,00 4.870,00 4.870,00 5.100,00		

22% rabatt ska dras av på angivna priser
OBS. Prislista inkl. moms

TEXTILE SIDE PANEL DOUBLE HEIGHT | 34

A foam-filled textile panel insert is mounted with fixed velcro onto a powder coated steel cover used on the outside or inside of the shelving. Textile on one side. Steel cover in army, charcoal or light grey.

Order produced



COVER	COLOUR		
	Army	Charcoal	Light grey
Powder coated steel	•	•	•

VARIANT	DIMENSION	BOX DIMENSION WEIGHT	PACKAGING	FABRIC	PRICE
H68	W29,5 x D1,6 x H68 cm W11.61" x D0.63" x H26.77"	W29,5 x D1,6 x H68 cm 3 kg W29 cm xD1 x H67,5 cm 0,50 kg	1 box 1 pcs.	Remix Surface By HAY Steelcut Steelcut Trio Canvas	2.270,00 2.270,00 2.510,00 2.510,00 2.590,00

INSIDE TEXTILE SIDE PANEL DOUBLE HEIGHT | 34

A foam-filled textile panel insert is mounted with fixed velcro onto a powder coated steel cover used on the outside or inside of the shelving. Textile on one side. Steel cover in army, charcoal or light grey.

Order produced



COVER	COLOUR		
	Army	Charcoal	Light grey
Powder coated steel	•	•	•

VARIANT	DIMENSION	BOX DIMENSION WEIGHT	PACKAGING	FABRIC	PRICE
H68	W29,5 x D1,6 x H68 cm W11.61" x D0.63" x H26.77"	W29,5 x D1,6 x H68 cm 3 kg W29 cm xD1 x H67,5 cm 0,50 kg	1 box 1 pcs.	Remix Surface By HAY Steelcut Steelcut Trio Canvas	2.120,00 2.120,00 2.360,00 2.360,00 2.440,00

22% rabatt ska dras av på angivna priser
OBS. Pristista inkl. moms

TEXTILE BACK PANEL DOUBLE HEIGHT | 100

A foam-filled textile panel insert is mounted with fixed velcro onto a powder coated steel cover used on the outside or inside of the shelving. Textile on one side. Steel cover in army, charcoal or light grey.

Order produced



COVER	COLOUR		
	Army	Charcoal	Light grey
Powder coated steel	•	•	•

VARIANT	DIMENSION	BOX DIMENSION WEIGHT	PACKAGING	FABRIC	PRICE
W100	W95,5 x D1,6 x H68 cm W37.6" x D0.63" x H26.77"	W95,5 x D1,6 x H68 cm 9 kg W95 x D1 x 67,5 cm 1,70 kg	1 box 1 pcs.	Remix Surface By HAY Steelcut Steelcut Trio Canvas	3.670,00 3.670,00 4.150,00 4.150,00 4.300,00

INSIDE TEXTILE BACK PANEL DOUBLE HEIGHT | 100

A foam-filled textile panel insert is mounted with fixed velcro onto a powder coated steel cover used on the outside or inside of the shelving. Textile on one side. Steel cover in army, charcoal or light grey.

Order produced



COVER	COLOUR		
	Army	Charcoal	Light grey
Powder coated steel	•	•	•

VARIANT	DIMENSION	BOX DIMENSION WEIGHT	PACKAGING	FABRIC	PRICE
W100	W95,5 x D1,6 x H68 cm W37.6" x D0.63" x H26.77"	W95,5 x D1,6 x H68 cm 9 kg W95 x D1 x 67,5 cm 1,70 kg	1 box 1 pcs.	Remix Surface By HAY Steelcut Steelcut Trio Canvas	3.520,00 3.520,00 4.000,00 4.000,00 4.150,00

22% rabatt ska dras av på angivna priser
OBS. Prislista inkl. moms

STEEL SLIDING DOOR | 100 | 150

Powder coated steel. Incl. handle in extruded powder coated aluminium.

100 cm | 1 sliding door opening right.

150 cm | 2 sliding doors opening right and left.

Order produced

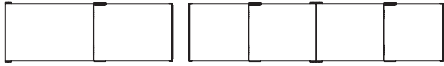

MATERIAL	COLOUR
	Army Charcoal Light grey

Powder coated steel | • • •

VARIANT	DIMENSION	BOX DIMENSION WEIGHT	PACKAGING	PRICE
W100	W95,5 x D2,7 x H33 W37.60" x D1.06" x H12.99"	1 pcs. W95.5 x D2.7 x H33 6 kg	1 box 1 pcs.	2.160,00
W150	2 x W72,75 x D2,7 x H33 cm 2 x W28.64" x D1.06" x H12.99"	2 pcs. W72,75 x D2,7 x H33 cm 4,50 kg	1 box 1 pcs.	3.120,00

STEEL SLIDING DOOR | 100 LEFT

Powder coated steel. Incl. handle in extruded powder coated aluminium.

1 sliding door opening left.

Order produced

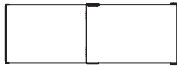

MATERIAL	COLOUR
	Army Charcoal Light grey

Powder coated steel | • • •

VARIANT	DIMENSION	BOX DIMENSION WEIGHT	PACKAGING	PRICE
W100	W95,5 x D33 x H2,7 W37.60" x D12.99" x H1.06"	1 pcs. W95.5 x D33 x H2.7 6 kg	1 box 1 pcs.	2.160,00

22% rabatt ska dras av på angivna priser
OBS. Prislista inkl. moms

STEEL SLIDING DOOR PREPARED FOR LOCK | 100 | 150

Powder coated steel. Incl. handle in extruded powder coated aluminium.
 100 cm | 1 sliding door opening right.
 150 cm | 2 sliding doors opening right and left.
 Prepared for Häfele Symo Universal HS 3 locking system, Type 0601-0700. The lock cylinder is packed separately. To be mounted by customer. Master key 210.113 is an option. Please specify the number of the lock cylinder and the key between 0601-700.
 Please note that 2 cylinders are needed for 1 set of 150 cm doors.

Order produced



MATERIAL	COLOUR
	Army Charcoal Light grey
Powder coated steel	• • •

VARIANT	DIMENSION	BOX DIMENSION WEIGHT	PACKAGING	PRICE
W100	W95,5 x D2,7 x H33 W37.60" x D1.06" x H12.99"	1 pcs. W95.5 x D2.7 x H33 6 kg	1 box 1 pcs.	2.940,00
W150	2 x W72,75 x D2,7 x H33 cm 2 x W28.64" x D1.06" x H12.99"	2 pcs. W72,75 x D2,7 x H33 cm 4,50 kg	1 box 1 pcs.	4.680,00
ADD-ON FOR LOCK				
Lock cylinder - keys not incl. 210.41.603	W2,5 x D1,5 x H1,5 W0.98" x D0.59" x H0.59"	1 pcs. W5 x D2 x H2 0.1 kg	1 box 1 pcs.	+ 150,00
Extra Key for lock cylinder 210.11.058	W2,5 x D1,5 x H0,2 W0.98" x D0.59" x H0.08"	1 pcs. W4 x D1 x H1 0.02 kg	1 box 1 pcs.	+ 119,00

STEEL SLIDING DOOR PREPARED FOR LOCK | 100 LEFT

Powder coated steel. Incl. handle in extruded powder coated aluminium.
 1 sliding door opening left.
 Prepared for Häfele Symo Universal HS 3 locking system, Type 0601-0700. The lock cylinder is packed separately. To be mounted by customer. Master key 210.113 is an option. Please specify the number of the lock cylinder and the key between 0601-700.

Order produced



MATERIAL	COLOUR
	Army Charcoal Light grey
Powder coated steel	• • •

VARIANT	DIMENSION	BOX DIMENSION WEIGHT	PACKAGING	PRICE
W100	W95,5 x D2,7 x H33 W37.60" x D1.06" x H12.99"	1 pcs. W95.5 x D2.7 x H33 6 kg	1 box 1 pcs.	2.940,00
ADD-ON FOR LOCK				
Lock cylinder - keys not incl. 210.41.603	W2,5 x D1,5 x H1,5 W0.98" x D0.59" x H0.59"	1 pcs. W5 x D2 x H2 0.1 kg	1 box 1 pcs.	+ 150,00
Extra Key for lock cylinder 210.11.058	W2,5 x D1,5 x H0,2 W0.98" x D0.59" x H0.08"	1 pcs. W4 x D1 x H1 0.02 kg	1 box 1 pcs.	+ 119,00

22% rabatt ska dras av på angivna priser
OBS. Prislista inkl. moms

STEEL SLIDING DOOR DOUBLE HEIGHT | 100

Powder coated steel. Incl. handle in extruded powder coated aluminium. 1 sliding door opening right. Adjustable screw in the bottom to make sure you get the best fit.

Order produced

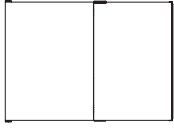

MATERIAL	COLOUR		
	Army	Charcoal	Light grey
Powder coated steel	•	•	•

VARIANT	DIMENSION	BOX DIMENSION WEIGHT	PACKAGING	PRICE
W100	W95,5 x D2,7 x H68 W37.60" x D1.06" x H26.77"	1 pcs. W95.5 x D2.7 x H68 12 kg	1 box 1 pcs.	3.400,00

STEEL SLIDING DOOR DOUBLE HEIGHT | 100 LEFT

Powder coated steel. Incl. handle in extruded powder coated aluminium. 1 sliding door opening left. Adjustable screw in the bottom to make sure you get the best fit.

Order produced

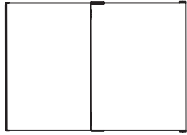

MATERIAL	COLOUR		
	Army	Charcoal	Light grey
Powder coated steel	•	•	•

VARIANT	DIMENSION	BOX DIMENSION WEIGHT	PACKAGING	PRICE
W100	W95,5 x D2,7 x H68 W37.60" x D1.06" x H26.77"	1 pcs. W95.5 x D2.7 x H68 12 kg	1 box 1 pcs.	3.400,00

STEEL SLIDING DOOR PREPARED FOR LOCK DOUBLE HEIGHT | 100

Powder coated steel. Incl. handle in extruded powder coated aluminium. 1 sliding door opening right. Adjustable screw in the bottom to make sure you get the best fit. Prepared for Häfele Symo Universal HS 3 locking system, Type 0601-0700. The lock cylinder is packed separately. To be mounted by customer. Master key 210.113 is an option. Please specify the number of the lock cylinder and the key between 0601-700.

Order produced

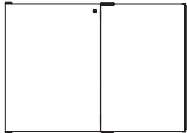

MATERIAL	COLOUR		
	Army	Charcoal	Light grey
Powder coated steel	•	•	•

VARIANT	DIMENSION	BOX DIMENSION WEIGHT	PACKAGING	PRICE
W100	W100 x D1 x H68 W39.37" x D0.39" x H26.77"	1 pcs. W100 x D1 x H68 12 kg	1 box 1 pcs.	4.200,00
ADD-ON FOR LOCK				
Lock cylinder - keys not incl. 210.41.603	W2,5 x D1,5 x H1,5 W0.98" x D0.59" x H0.59"	1 pcs. W5 x D2 x H2 0.1 kg	1 box 1 pcs.	+ 150,00
Extra Key for lock cylinder 210.11.058	W2,5 x D1,5 x H0,2 W0.98" x D0.59" x H0.08"	1 pcs. W4 x D1 x H1 0.02 kg	1 box 1 pcs.	+ 119,00

22% rabatt ska dras av på angivna priser

OBS. Prislista inkl. moms

STEEL SLIDING DOOR PREPARED FOR LOCK DOUBLE HEIGHT | 100 LEFT

Powder coated steel. Incl. handle in extruded powder coated aluminium. 1 sliding door opening left. Adjustable screw in the bottom to make sure you get the best fit. Prepared for Häfele Symo Universal HS 3 locking system, Type 0601-0700. The lock cylinder is packed separately. To be mounted by customer. Master key 210.113 is an option. Please specify the number of the lock cylinder and the key between 0601-700.

Order produced

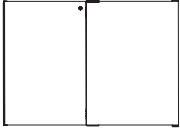

MATERIAL	COLOUR		
	Army	Charcoal	Light grey
Powder coated steel	•	•	•

VARIANT	DIMENSION	BOX DIMENSION WEIGHT	PACKAGING	PRICE
W100	W100 x D1 x H68 W39.37" x D0.39" x H26.77"	1 pcs. W100 x D1 x H68 12 kg	1 box 1 pcs.	4.200,00
ADD-ON FOR LOCK				
Lock cylinder - keys not incl. 210.41.603	W2,5 x D1,5 x H1,5 W0.98" x D0.59" x H0.59"	1 pcs. W5 x D2 x H2 0.1 kg	1 box 1 pcs.	+ 150,00
Extra Key for lock cylinder 210.11.058	W2,5 x D1,5 x H0,2 W0.98" x D0.59" x H0.08"	1 pcs. W4 x D1 x H1 0.02 kg	1 box 1 pcs.	+ 119,00

22% rabatt ska dras av på angivna priser
OBS. Prislista inkl. moms

**HIGH DRAWER INCL. MOUNTING SET | 34 | SET OF 1
OR DOUBLE HEIGHT | SET OF 2**

Powder coated steel. It is possible to post mount lock bar or middle bar on double height drawers set of 2. Set of 2 drawers is used with double height profiles. Set of 1 drawer is used with single height profiles. Please note that all shelving units with drawers require wall- or floor safety brackets. Max load 15 kg. pr. drawer.

Order produced

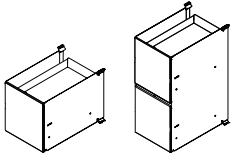

MATERIAL	COLOUR		
	Army	Charcoal	Light grey
Powder coated steel	•	•	•

VARIANT	DIMENSION	BOX DIMENSION WEIGHT	PACKAGING	PRICE
H33	W34 x D48 x H33 cm W13.39" x D18.90" x H12.99"		1 box 1 pcs.	6.440,00
H68	W34 x D48 x H68 cm W13.39" x D18.90" x H26.77"		1 box 1 pcs.	12.060,00

**HIGH DRAWER INCL. MOUNTING SET100 | SET OF 1
OR DOUBLE HEIGHT | SET OF 2**

Powder coated steel. It is possible to post mount lock bar or middle bar on double height drawers set of 2. Set of 2 drawers is used with double height profiles. Set of 1 drawer is used with single height profiles. Please note that all shelving units with drawers require wall- or floor safety brackets. Max load 15 kg. pr. drawer.

Order produced

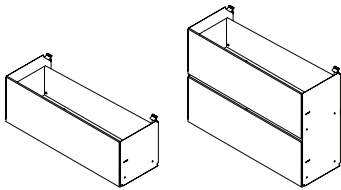

MATERIAL	COLOUR		
	Army	Charcoal	Light grey
Powder coated steel	•	•	•

VARIANT	DIMENSION	BOX DIMENSION WEIGHT	PACKAGING	PRICE
H33	W100 x D34 x H33 cm W39.37" x D13.36" x H12.99"		1 box 1 pcs.	7.210,00
H68	W100 x D34 x H68 cm W39.37" x D13.36" x H26.77"		1 box 1 pcs.	14.400,00

22% rabatt ska dras av på angivna priser
OBS. Pristista inkl. moms

**DRAWER INCL. MOUNTING SET 34 | SET OF 2
OR DOUBLE HEIGHT | SET OF 4**

Powder coated steel. It is possible to post mount lock bar or middle bar. Set of 2 drawers is used with single height profiles. Set of 4 drawers is used with double height profiles. Please note that all shelving units with drawers require wall- or floor safety brackets. Max load 15 kg. pr. drawer.

Order produced

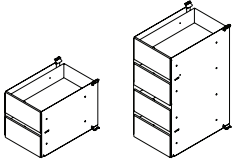

MATERIAL	COLOUR
Powder coated steel	Army Charcoal Light grey

VARIANT	DIMENSION	BOX DIMENSION WEIGHT	PACKAGING	PRICE
H33	W34 x D48 x H33 cm W13.39" x D18.90" x H12.99"		1 box 1 pcs.	9.700,00
H68	W34 x D48 x H68 cm W13.39" x D18.90" x H26.77"		1 box 1 pcs.	19.100,00

**DRAWER INCL. MOUNTING SET 100 | SET OF 2
OR DOUBLE HEIGHT | SET OF 4**

Powder coated steel. It is possible to post mount lock bar or middle bar. Set of 2 drawers is used with single height profiles. Set of 4 drawers is used with double height profiles. Please note that all shelving units with drawers require wall- or floor safety brackets. Max load 15 kg. pr. drawer.

Order produced

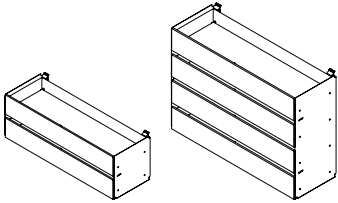

MATERIAL	COLOUR
Powder coated steel	Army Charcoal Light grey

VARIANT	DIMENSION	BOX DIMENSION WEIGHT	PACKAGING	PRICE
H33	W100 x D34 x H33 cm W39.37" x D13.36" x H12.99"		1 box 1 pcs.	11.300,00
H68	W100 x D34 x H68 cm W39.37" x D13.36" x H26.77"		1 box 1 pcs.	22.300,00

MIDDLE BAR FOR DRAWER | 34 | 100

Powder coated steel. Can be used to close the gap between two drawers.
To be mounted by customer.

Order produced



MATERIAL	COLOUR
Powder coated steel	Army Charcoal Light grey

VARIANT	DIMENSION	BOX DIMENSION WEIGHT	PACKAGING	PRICE
W34	W29,5 x D6,8 x H2,6 W11.61" x D2.68" x H1.02"	1 pcs. W29.5 x D6.8 x H2.6 1 kg	1 box 1 pcs.	790,00
W100	W95,5 x D6,8 x H2,6 W37.60" x D2.68" x H1.02"	1 pcs. W95.5 x D6.8 x H2.6 2.5 kg	1 box 1 pcs.	1.000,00

22% rabatt ska dras av på angivna priser
OBS. Prislista inkl. moms

LOCK BAR DRAWER PREPARED FOR LOCK 34 | 100

Powder coated steel. Can be used to close the gap between two drawers. Please note for set of 4 drawers only 2 lock bars and 1 middle bar. Prepared for Häfele Symo Universal HS 3 locking system, Type 0601-0700. The lock cylinder is packed separately. To be mounted by customer. Master key 210.113 is an option. Please specify the number of the lock cylinder and the key between 0601-700.

Order produced



MATERIAL	COLOUR		
	Army	Charcoal	Light grey
Powder coated steel	•	•	•

VARIANT	DIMENSION	BOX DIMENSION WEIGHT	PACKAGING	PRICE
W34	W29,5 x D6,8 x H2,6 W11.61" x D2.68" x H1.02"	1 pcs. W29.5 x D6.8 x H2.6 1 kg	1 box 1 pcs.	1.250,00
W100	W95,5 x D6,8 x H2,6 W37.60" x D2.68" x H1.02"	1 pcs. W95.5 x D6.8 x H2.6 2.5 kg	1 box 1 pcs.	1.500,00
ADD-ON FOR LOCK				
Lock cylinder - keys not incl. 210.41.603	W2,5 x D1,5 x H1,5 W0.98" x D0.59" x H0.59"	1 pcs. W5 x D2 x H2 0.1 kg	1 box 1 pcs.	+ 150,00 + 119,00

EXTRA LOCK CYLINDER

Lock cylinder core for left or right hand use. Nickel plated zinc alloy housing, brass plate levers. Standard locking system - Häfele Symo Universal HS 3, Type 0601-0700. Häfele item no. 210.41.603. Please specify the number of the lock cylinder and the key between 0601-700. Master key is an option.

Order produced



VARIANT	DIMENSION	BOX DIMENSION WEIGHT	PACKAGING	PRICE
EXTRA LOCK CYLINDER	W2,5 x D1,5 x H1,5 W0.98" x D0.59" x H0.59"	1 pcs. W5 x D2 x H2 0.1 kg	1 box 1 pcs.	150,00

EXTRA KEY FOR LOCK CYLINDER

Key for lock cylinder. Nickel-plated steel. Standard locking system - Häfele Symo Universal HS 3, Type 0601-0700. Häfele item no 210.11.058. Please specify the number of the lock cylinder and the key between 0601-700. Master key is an option.

Order produced



VARIANT	DIMENSION	BOX DIMENSION WEIGHT	PACKAGING	PRICE
EXTRA KEY FOR LOCK CYLINDER	W2,5 x D1,5 x H0,2 W0.98" x D0.59" x H0.08"	1 pcs. W4 x D1 x H1 0.02 kg	1 box 1 pcs.	119,00

22% rabatt ska dras av på angivna priser
OBS. Prislista inkl. moms

MASTER KEY

Master key for Symo Universal cylinder core SYMO 3000-, HS3. Nickel plated steel. Häfele item no. 210.11.003

Order produced



VARIANT	DIMENSION	BOX DIMENSION WEIGHT	PACKAGING	PRICE
MASTER KEY	W2,5 x D1,5 x H0,2 W0.98" x D0.59" x H0.08"	1 pcs. W0 x D0 x H0 0 kg	1 box 1 pcs.	150,00

EXCHANGE KEY FOR LOCK CYLINDER

Exchange key for removing the lock cylinder. Nickel plated steel. Häfele item no. 210.11.090

Order produced



VARIANT	DIMENSION	BOX DIMENSION WEIGHT	PACKAGING	PRICE
EXCHANGE KEY FOR LOCK CYLINDER	W2,5 x D1,5 x H0,2 W0.98" x D0.59" x H0.08"	1 pcs. W4 x D1 x H1 0.02 kg	1 box 1 pcs.	250,00

22% rabatt ska dras av på angivna priser
OBS. Prislista inkl. moms

WALL BRACKET SHELF | SET OF 2

WALL BRACKET FOR DOUBLE HEIGHT SHELF | SET OF 2

Shelf bottom requires shelf wall bracket. Available for wooden- and steel wall panels.

Stock item

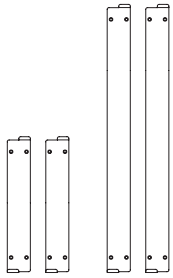

MATERIAL	COLOUR		
	Army	Charcoal	Light grey
Powder coated steel	•	•	•

VARIANT	DIMENSION	BOX DIMENSION WEIGHT	PACKAGING	PRICE
H36	W6 x D2,5 x H36 W2.36" x D0.98" x H14.17"	1 pcs. W44 x D6 x H2,5 1.70 kg	1 box 1 pcs.	250,00
H71	W6 x D2,5 x H71 cm W2.36" x D0.98" x H27.95"	1 pcs. W79 x D6 x H2,5 3.30 kg	1 box 1 pcs.	500,00

WALL SAFETY BRACKETS FOR SHELVING SYSTEM | SET OF 2

Powder coated steel and aluminium. Works with both shelf and tray. Can be used together with wooden wall panels or steel wall panels. Please follow the guidelines in our instruction manuals. It does not work with textile panels. wall screws and plugs are not incl. Max. 40 mm from the wall.

Stock item

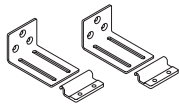

MATERIAL	COLOUR		
	Army	Charcoal	Light grey
Powder coated steel	•	•	•

VARIANT	DIMENSION	BOX DIMENSION WEIGHT	PACKAGING	PRICE
	W4 x D5,5 x H5 W1.57" x D2.17" x H1.97"	1 pcs. W4 x D5.5 x H5 12 kg	1 box 1 pcs.	250,00

FLOOR SAFETY BRACKETS FOR SHELVING SYSTEM | SET OF 2

Powder coated steel. Works with both shelf and tray. Please follow the guidelines in our instruction manuals. Floor screws and plugs are not incl.

Stock item

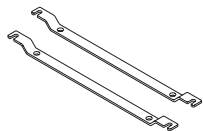

MATERIAL	COLOUR		
	Army	Charcoal	Light grey
Powder coated steel	•	•	•

VARIANT	DIMENSION	BOX DIMENSION WEIGHT	PACKAGING	PRICE
	W40 x D2 x H3 W15.75" x D0.79" x H1.18"	1 pcs. W40 x D2 x H3 0.7 kg	1 box 1 pcs.	500,00

22% rabatt ska dras av på angivna priser
OBS. Prislista inkl. moms

REPAIR KIT

Laquer
Sales QTY.: min. 10 pcs. mix

Stock item



MATERIAL	COLOUR		
	Army	Charcoal	Light grey
Laquer	•	•	•

VARIANT	DIMENSION	BOX DIMENSION WEIGHT	PACKAGING	PRICE
	W2 x D2 x H6,5 W0.79" x D0.79" x H2.56"	1 pcs. W2 x D2 x H6.5 0.1 kg	1 box 1 pcs.	150,00

WHEELS | SET OF 4

Ø55 mm. Max. height with wheels is 2 layers - 1 bottom and 1 top. Can be mounted on both shelf and tray bottom.
Set of 4 (2 wheels with brake and 2 wheels without).

Stock item

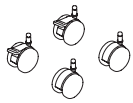

MATERIAL	COLOUR	
	Black	
Plastic	•	

VARIANT	DIMENSION	BOX DIMENSION WEIGHT	PACKAGING	PRICE
	W5,5 x D5,5 x H3,6 W2.17" x D2.17" x H1.42"	1 pcs. W18.5 x D16 x H4.5 0.4 kg	1 box 1 pcs.	500,00

SHELF BOOK DIVIDER | LEFT OR RIGHT

Book dividers in powder coated steel.

Stock item

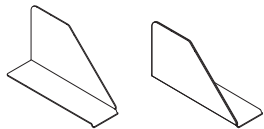

MATERIAL	COLOUR		
	Army	Charcoal	Light grey
Powder coated steel	•	•	•

VARIANT	DIMENSION	BOX DIMENSION WEIGHT	PACKAGING	PRICE
LEFT	W14 x D9 x H31,3 W5.51" x D3.54" x H12.32"	1 pcs. W35 x D20 x H10 0.7 kg	1 box 1 pcs.	400,00
RIGHT	W14 x D9 x H31,3 W5.51" x D3.54" x H12.32"	1 pcs. W35 x D20 x H10 0.7 kg	1 box 1 pcs.	400,00

22% rabatt ska dras av på angivna priser
OBS. Prislista inkl. moms

TROLLEY A | 1 DRAWER & TRAY TOP

Trolley in powder coated steel, die cast extruded aluminium. Incl. 4 x Ø55 mm wheels, 2 with brake.
Incl. Standard locking system - Häfele Symo Universal HS, unsorted numbers.

Stock item

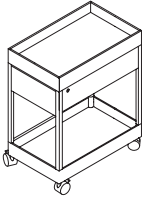

MATERIAL	COLOUR		
	Army	Charcoal	Light grey
Powder coated steel	•	•	•

VARIANT	DIMENSION	BOX DIMENSION WEIGHT	PACKAGING	PRICE
TROLLEY A	W34 x D55 x H67,5 W13.39" x D21.65" x H26.57"	1 pcs. W45 x D66 x H78 20 kg	1 box 1 pcs.	8.600,00

TROLLEY B | 3 DRAWER & TRAY TOP

Trolley in powder coated steel, die cast extruded aluminium. Incl. 4 x Ø55 mm wheels, 2 with brake.
Incl. Standard locking system - Häfele Symo Universal HS, unsorted numbers.

Stock item

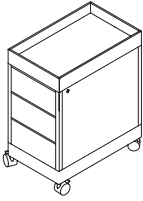

MATERIAL	COLOUR		
	Army	Charcoal	Light grey
Powder coated steel	•	•	•

VARIANT	DIMENSION	BOX DIMENSION WEIGHT	PACKAGING	PRICE
TROLLEY B	W34 x D55 x H67,5 W13.39" x D21.65" x H26.57"	1 pcs. W45 x D66 x H78 27 kg	1 box 1 pcs.	11.750,00

22% rabatt ska dras av på angivna priser
OBS. Prislista inkl. moms

TABLE | 4 LEGS

12 mm tabletop in MDF with linoleum or 10 mm tabletop in MDF with veneer.
Tabletop is placed inside the table frame. 4 legs incl. adjustable gliders.
Requires assembly.

Order produced

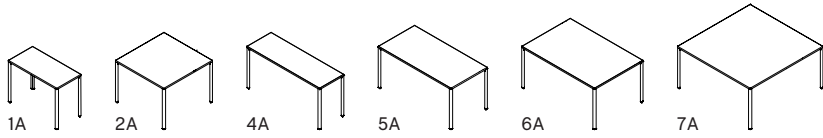

FRAME & LEGS	TABLETOP			
	Army powder coated aluminium	Cloud grey linoleum	Dark grey linoleum	Green linoleum
Charcoal powder coated aluminium	•	•	•	•
Light grey powder coated aluminium	•	•	•	•

VARIANT	DIMENSION	BOX DIMENSION WEIGHT	PACKAGING	PRICE
1A	L100 x W50 x H74 cm L39.37" x W19.69" x 29.13"	W163 x D42 x H7,5 cm 7,0 kg W120 x D70 x H2,5 cm 7,3 kg W75 x D27 x H8 cm 11 kg	3 box 1 pcs.	12.180,00
2A	L100 x W100 x H74 cm L39.37" x W39.37" x 29.13"	W160 x D42 x H16 cm 12 kg W120 x D120 x H2,5 cm 12,9 kg W75 x D27 x H8 cm 11 kg	3 box 1 pcs.	14.250,00
4A	L150 x W50 x H74 cm L59.06 x W19.69 x 29.13"	W42 x D163 x H15,5 cm 8,5 kg W163,5 x D63,5 x H2,5 cm 9,8 kg W75 x D27 x H8 cm 11 kg	3 box 1 pcs.	15.500,00
5A	L150 x W75 x H74 cm L59.06 x W29.53 x 29.13"	W160 x D42 x H16 cm 9 kg W163,5 x D88,5 x H2,5 cm 14,6 kg W75 x D27 x H8 cm 11 kg	3 box 1 pcs.	16.900,00
6A	L150 x W100 x H74 cm L59.06 x W39.37" x 29.13"	W160 x D42 x H16 cm 14 kg W163,5 x D113,5 x H2,5 cm 19,3 kg W75 x D27 x H8 cm 11 kg	3 box 1 pcs.	16.750,00
7A	L150 x W150 x H74 cm L59.06 x W59.06 x 29.13"	W160 x D42 x H16 cm 18 kg W163,5 x D163,5 x H2,5 cm 28,7 kg W75 x D27 x H8 cm 11 kg	3 box 1 pcs.	19.700,00

TABLE | 4 LEGS

12 mm tabletop in MDF with linoleum or 10 mm tabletop in MDF with veneer.
Tabletop is placed inside the table frame. 4 legs incl. adjustable gliders.
Requires assembly.

Order produced

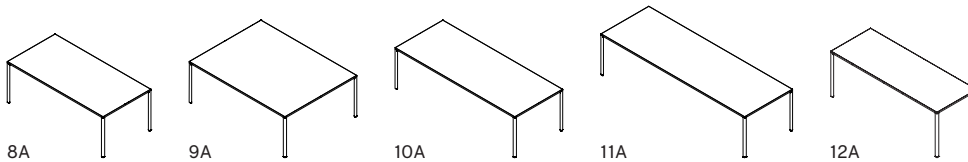

FRAME & LEGS	TABLETOP			
	Army powder coated aluminium	Cloud grey linoleum	Dark grey linoleum	Green linoleum
Charcoal powder coated aluminium	•	•	•	•
Light grey powder coated aluminium	•	•	•	•

VARIANT	DIMENSION	BOX DIMENSION WEIGHT	PACKAGING	PRICE
8A	L200 x W100 x H74 cm L78.74" x W39.37" x 29.13"	W210 x D42 x H16 cm 18 kg W214 x D114 x H4,5 cm 32 kg W75 x D27 x H8 cm 6 kg	3 box 1 pcs.	19.550,00
9A	L200 x W75 x H74 cm L78.74" x W29.53" x 29.13"	W210 x D42 x H16 cm 16 kg W213,5 x D88,5 x H2,5 cm 19,1kg W79 x D27 x H8 cm 11 kg	3 box 1 pcs.	22.500,00
10A	L250 x W100 x H74 cm L78.74" x W39.37" x 29.13"	W252 x D42 x H16 cm 22 kg W264 x D114 x H4,5 cm 38 kg W75 x D27 x H8 cm 11 kg	3 box 1 pcs.	25.950,00
11A	L300 x W100 x H74 cm L98.43" x W39.37" x 29.13"	W320 x D20 x H14,5 cm 20 kg W314 x D114 x H4,5 cm 41 kg W75 x D27 x H8 cm 6 kg	3 box 1 pcs.	27.850,00
12A	L200 x W75 x H74 cm L78.74" x W29.53" x 29.13"	W210 x D42 x H16 cm 16 kg W213,5 x D88,5 x H2,5 cm 19,1kg W79 x D27 x H8 cm 11 kg	3 box 1 pcs.	19.250,00

22% rabatt ska dras av på angivna priser
OBS. Prislista inkl. moms

TABLE INCL. SINGLE PLUG & PLAY | 4 LEGS

12 mm tabletop in MDF with linoleum or 10 mm tabletop in MDF with veneer. Incl. 2 x Single Plug & Play Center. Tabletop is placed inside the table frame. 4 legs incl. adjustable gliders. Requires assembly. STEP modules not included.

Order produced

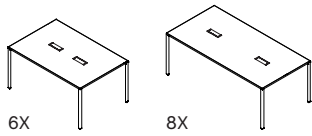

FRAME & LEGS		TABLETOP			
Army powder coated aluminium		Cloud grey linoleum	Dark grey linoleum	Green linoleum	Grey linoleum
Charcoal powder coated aluminium					Water-based lacquered oak veneer
Light grey powder coated aluminium					

VARIANT	DIMENSION	BOX DIMENSION WEIGHT	PACKAGING	PRICE
6X	L150 x W100 x H74 cm L59,06 x W39.37" x 29.13"	W160 x D42 x H16 cm 14 kg W163,5 x D113,5 x H2,5 cm 19,3 kg W75 x D27 x H8 cm 11 kg	3 box 1 pcs.	23.000,00
8X	L200 x W100 x H74 cm L78.74" x W39.37" x 29.13"	W210 x D42 x H16 cm 18 kg W214 x D114 x H4,5 cm 32 kg W75 x D27 x H8 cm 6 kg	3 box 1 pcs.	26.900,00

TABLE INCL. CABLE MANAGEMENT EDGE | 4 LEGS

12 mm tabletop in MDF with linoleum or 10 mm tabletop in MDF with veneer. Incl. 40 mm cable management cover. Tabletop is placed inside the table frame. 4 legs incl. adjustable gliders. Requires assembly. STEP modules not included.

Order produced

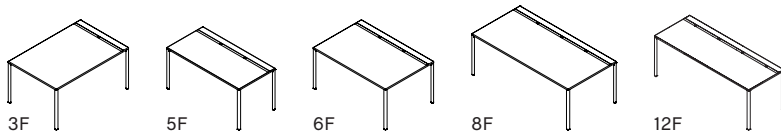

FRAME & LEGS		TABLETOP			
Army powder coated aluminium		Cloud grey linoleum	Dark grey linoleum	Green linoleum	Grey linoleum
Charcoal powder coated aluminium					Water-based lacquered oak veneer
Light grey powder coated aluminium					

VARIANT	DIMENSION	BOX DIMENSION WEIGHT	PACKAGING	PRICE
3F	L100 x W50 x H74 cm L39.37" x W19.69" x 29.13"	W160 x D42 x H16 cm 14 kg W164 x D114 x H4,5 cm 26 kg W75 x D27 x H8 cm 6 kg	3 box 1 pcs.	19.400,00
5F	L150 x W75 x H74 cm L59.06 x W29.53 x 29.13"	W160 x D42 x H16 cm 17 kg W75 x D27 x H8 cm 11 kg W164 x D89 x H4,5 cm 27 kg	3 box 1 pcs.	21.600,00
6F	L150 x W100 x H74 cm L59,06 x W39.37" x 29.13"	W160 x D42 x H16 cm 16 kg W75 x D27 x H8 cm 11 kg W164 x D114 x H4,5 cm 26 kg	3 box 1 pcs.	21.450,00
8F	L200 x W100 x H74 cm L78.74" x W39.37" x 29.13"	W202 x D42 x H14,5 cm 16 kg W75 x D27 x H8 cm 6 kg W214 x D114 x H4,5 cm 32 kg	3 box 1 pcs.	21.400,00
12F	L200 x W75 x H74 cm L78.74" x W29.53 x 29.13"	W210 x D42 x H16 cm 16 kg W213,5 x D88,5 x H2,5 cm 19,1kg W79 x D27 x H8 cm 11 kg	3 box 1 pcs.	25.000,00

22% rabatt ska dras av på angivna priser
OBS. Prislista inkl. moms

TABLE INCL. PLUG & PLAY CABLE MANAGEMENT EDGE | 4 LEGS

12 mm tabletop in MDF with linoleum or 10 mm tabletop in MDF with veneer. Incl. 80 mm plug & play cable management cover. Tabletop is placed inside the table frame. 4 legs incl. adjustable gliders. Requires assembly. STEP modules not included.

Order produced

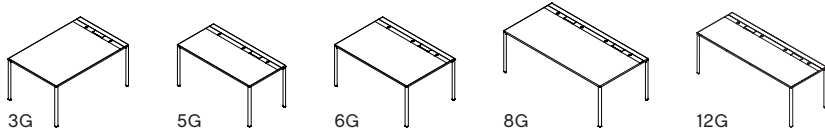

FRAME & LEGS	TABLETOP			
	Army powder coated aluminium	Cloud grey linoleum	Dark grey linoleum	Green linoleum
Charcoal powder coated aluminium	•	•	•	•
Light grey powder coated aluminium	•	•	•	•

VARIANT	DIMENSION	BOX DIMENSION WEIGHT	PACKAGING	PRICE
3G	L100 x W50 x H74 cm L39.37" x W19.69" x 29.13"	W160 x D42 x H16 cm 14 kg W164 x D114 x H4,5 cm 26 kg W75 x D27 x H8 cm 6 kg	3 box 1 pcs.	21.450,00
5G	L150 x W75 x H74 cm L59.06" x W29.53" x 29.13"	W160 x D42 x H16 cm 17 kg W75 x D27 x H8 cm 11 kg W164 x D89 x H4,5 cm 27 kg	3 box 1 pcs.	23.150,00
6G	L150 x W100 x H74 cm L59,06" x W39.37" x 29.13"	W160 x D42 x H16 cm 16 kg W75 x D27 x H8 cm 11 kg W164 x D114 x H4,5 cm 26 kg	3 box 1 pcs.	23.000,00
8G	L200 x W100 x H74 cm L78.74" x W39.37" x 29.13"	W202 x D42 x H14,5 cm 16 kg W75 x D27 x H8 cm 6 kg W214 x D114 x H4,5 cm 32 kg	3 box 1 pcs.	26.900,00
12G	L200 x W75 x H74 cm L78.74" x W29.53" x 29.13"	W210 x D42 x H16 cm 16 kg W213,5 x D88,5 x H2,5 cm 19,1kg W79 x D27 x H8 cm 11 kg	3 box 1 pcs.	26.600,00

TABLE INCL. CABLE MANAGEMENT EDGE 34 CM | 4 LEGS

12 mm tabletop in MDF with linoleum or 10 mm tabletop in MDF with veneer. Incl. 40 mm cable management cover. Tabletop is placed inside the table frame. 4 legs incl. adjustable gliders. Requires assembly. STEP modules not included.

Order produced

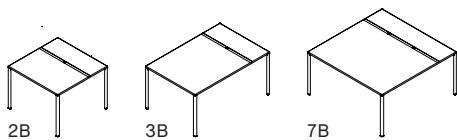

FRAME & LEGS	TABLETOP			
	Army powder coated aluminium	Cloud grey linoleum	Dark grey linoleum	Green linoleum
Charcoal powder coated aluminium	•	•	•	•
Light grey powder coated aluminium	•	•	•	•

VARIANT	DIMENSION	BOX DIMENSION WEIGHT	PACKAGING	PRICE
2B	L100 x W100 x H74 cm L39.37" x W39.37" x 29.13"	W160 x D42 x H16 cm 12 kg W114 x D114 x H4,5 cm 22 kg W75 x D27 x H8 cm 11 kg	3 box 1 pcs.	17.650,00
3B	L100 x W150 x H74 cm L39.37" x W59.06" x 29.13"	W160 x D42 x H16 cm 14 kg W164 x D114 x H4,5 cm 26 kg W75 x D27 x H8 cm 6 kg	3 box 1 pcs.	19.400,00
7B	L150 x W150 x H74 cm L59.06 x W59.06 x 29.13"	W160 x D42 x H16 cm 21 kg W164 x D89 x H9 cm 48 kg W75 x D27 x H8 cm 11 kg	3 box 1 pcs.	21.600,00

22% rabatt ska dras av på angivna priser
OBS. Prislista inkl. moms

TABLE INCL. PLUG & PLAY CABLE MANAGEMENT EDGE 34 CM | 4 LEGS

12 mm tabletop in MDF with linoleum or 10 mm tabletop in MDF with veneer. Incl. 80 mm plug & play cable management cover. Tabletop is placed inside the table frame. 4 legs incl. adjustable gliders. Requires assembly. STEP modules not included.

Order produced

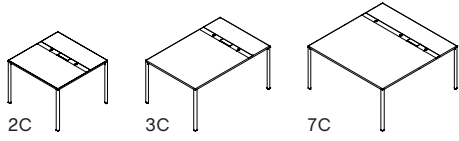

FRAME & LEGS	TABLETOP			
	Cloud grey linoleum	Dark grey linoleum	Green linoleum	Grey linoleum
Army powder coated aluminium	•	•	•	•
Charcoal powder coated aluminium	•	•	•	•
Light grey powder coated aluminium	•	•	•	•

VARIANT	DIMENSION	BOX DIMENSION WEIGHT	PACKAGING	PRICE
2C	L100 x W100 x H74 cm L39.37" x W39.37" x 29.13"	W160 x D42 x H16 cm 12 kg W114 x D114 x H4,5 cm 22 kg W75 x D27 x H8 cm 11 kg	3 box 1 pcs.	18.950,00
3C	L100 x W150 x H74 cm L39.37" x W59.06" x 29.13"	W160 x D42 x H16 cm 14 kg W164 x D114 x H4,5 cm 26 kg W75 x D27 x H8 cm 6 kg	3 box 1 pcs.	21.450,00
7C	L150 x W150 x H74 cm L59.06 x W59.06 x 29.13"	W160 x D42 x H16 cm 21 kg W164 x D89 x H9 cm 48 kg W75 x D27 x H8 cm 11 kg	3 box 1 pcs.	26.300,00

TABLE INCL. CABLE MANAGEMENT EDGE 34 CM | PREPARED FOR TOP TRAY DIVIDER | 4 LEGS

12 mm tabletop in MDF with linoleum or 10 mm tabletop in MDF with veneer. Incl. 40 mm cable management cover prepared for top divider edge. Tabletop is placed inside the table frame. 4 legs incl. adjustable gliders. Requires assembly. STEP modules, top tray and single profiles not included.

Order produced

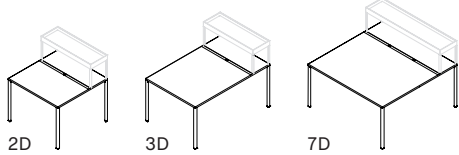

FRAME & LEGS	TABLETOP			
	Cloud grey linoleum	Dark grey linoleum	Green linoleum	Grey linoleum
Army powder coated aluminium	•	•	•	•
Charcoal powder coated aluminium	•	•	•	•
Light grey powder coated aluminium	•	•	•	•

VARIANT	DIMENSION	BOX DIMENSION WEIGHT	PACKAGING	PRICE
2D	L100 x W100 x H74 cm L39.37" x W39.37" x 29.13"	W160 x D42 x H16 cm 12 kg W114 x D114 x H4,5 cm 22 kg W75 x D27 x H8 cm 11 kg	3 box 1 pcs.	18.400,00
3D	L100 x W150 x H74 cm L39.37" x W59.06" x 29.13"	W160 x D42 x H16 cm 14 kg W164 x D114 x H4,5 cm 26 kg W75 x D27 x H8 cm 6 kg	3 box 1 pcs.	20.200,00
7D	L150 x W150 x H74 cm L59.06 x W59.06 x 29.13"	W160 x D42 x H16 cm 21 kg W164 x D89 x H9 cm 48 kg W75 x D27 x H8 cm 11 kg	3 box 1 pcs.	22.400,00

22% rabatt ska dras av på angivna priser

OBS. Prislista inkl. moms

TABLE INCL. PLUG & PLAY CABLE MANAGEMENT EDGE 34 CM | PREPARED FOR TOP TRAY DIVIDER | 4 LEGS

12 mm tabletop in MDF with linoleum or 10 mm tabletop in MDF with veneer. Incl. 80 mm plug & play cable management cover prepared for top divider edge. Tabletop is placed inside the table frame. 4 legs incl. adjustable gliders. Requires assembly. STEP modules, top tray and single profiles not included.

Order produced

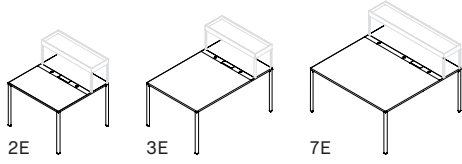

FRAME & LEGS		TABLETOP			
Army powder coated aluminium	•	Cloud grey linoleum	•	Dark grey linoleum	•
Charcoal powder coated aluminium	•	Green linoleum	•	Grey linoleum	•
Light grey powder coated aluminium	•	Water-based lacquered oak veneer	•		•

VARIANT	DIMENSION	BOX DIMENSION WEIGHT	PACKAGING	PRICE
2E	L100 x W100 x H74 cm L39.37" x W39.37" x 29.13"	W160 x D42 x H16 cm 12 kg W114 x D114 x H4,5 cm 22 kg W75 x D27 x H8 cm 11 kg	3 box 1 pcs.	19.700,00
3E	L100 x W150 x H74 cm L39.37" x W59.06" x 29.13"	W160 x D42 x H16 cm 14 kg W164 x D114 x H4,5 cm 26 kg W75 x D27 x H8 cm 6 kg	3 box 1 pcs.	22.200,00
7E	L150 x W150 x H74 cm L59.06 x W59.06 x 29.13"	W160 x D42 x H16 cm 21 kg W164 x D89 x H9 cm 48 kg W75 x D27 x H8 cm 11 kg	3 box 1 pcs.	27.100,00

TABLE INCL. CABLE MANAGEMENT | PREPARED FOR TOP TRAY DIVIDER AND TABLE SCREENS EDGE | 4 LEGS

12 mm tabletop in MDF with linoleum or 10 mm tabletop in MDF with veneer. Incl. 40 mm cable management cover and prepared for top divider and table screens edge. Tabletop is placed inside the table frame. 4 legs incl. adjustable gliders. Requires assembly. Table screens, STEP modules, top tray and single profiles not included.

Order produced

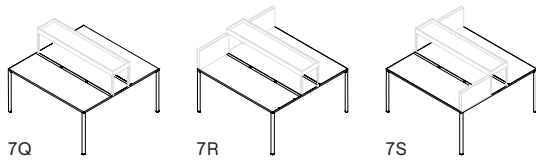

FRAME & LEGS		TABLETOP			
Army powder coated aluminium	•	Cloud grey linoleum	•	Dark grey linoleum	•
Charcoal powder coated aluminium	•	Green linoleum	•	Grey linoleum	•
Light grey powder coated aluminium	•	Water-based lacquered oak veneer	•		•

VARIANT	DIMENSION	BOX DIMENSION WEIGHT	PACKAGING	PRICE
7Q	L150 x W150 x H74 cm L59.06 x W59.06 x 29.13"	W160 x D42 x H16 cm 21 kg W164 x D89 x H9 cm 48 kg W75 x D27 x H8 cm 11 kg	3 box 1 pcs.	25.700,00
7R	L150 x W150 x H74 cm L59.06 x W59.06 x 29.13"	W160 x D42 x H16 cm 21 kg W164 x D89 x H9 cm 48 kg W75 x D27 x H8 cm 11 kg	3 box 1 pcs.	28.000,00
7S	L150 x W150 x H74 cm L59.06 x W59.06 x 29.13"	W160 x D42 x H16 cm 21 kg W164 x D89 x H9 cm 48 kg W75 x D27 x H8 cm 11 kg	3 box 1 pcs.	28.000,00

22% rabatt ska dras av på angivna priser

OBS. Prislista inkl. moms

TABLE INCL. PLUG & PLAY CABLE MANAGEMENT | PREPARED FOR TOP TRAY DIVIDER AND TABLE SCREENS EDGE | 4 LEGS

12 mm tabletop in MDF with linoleum or 10 mm tabletop in MDF with veneer. Incl. 80 mm plug & play cable management cover and prepared for top divider and table screens edge. Tabletop is placed inside the table frame. 4 legs incl. adjustable gliders. Requires assembly. Table screens, STEP modules, top tray and single profiles not included.

Order produced

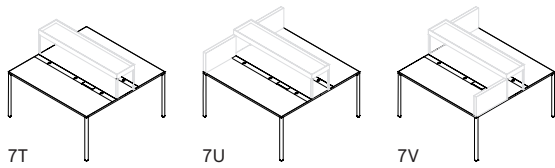

FRAME & LEGS		TABLETOP				
Army powder coated aluminium		Cloud grey linoleum	Dark grey linoleum	Green linoleum	Grey linoleum	Water-based lacquered oak veneer
Charcoal powder coated aluminium		•	•	•	•	
Light grey powder coated aluminium		•	•	•	•	

VARIANT	DIMENSION	BOX DIMENSION WEIGHT	PACKAGING	PRICE
7T	L150 x W150 x H74 cm L59.06 x W59.06 x 29.13"	W160 x D42 x H16 cm 21 kg W164 x D89 x H9 cm 48 kg W75 x D27 x H8 cm 11 kg	3 box 1 pcs.	27.250,00
7U	L150 x W150 x H74 cm L59.06 x W59.06 x 29.13"	W160 x D42 x H16 cm 21 kg W164 x D89 x H9 cm 48 kg W75 x D27 x H8 cm 11 kg	3 box 1 pcs.	29.550,00
7V	L150 x W150 x H74 cm L59.06 x W59.06 x 29.13"	W160 x D42 x H16 cm 21 kg W164 x D89 x H9 cm 48 kg W75 x D27 x H8 cm 11 kg	3 box 1 pcs.	29.550,00

TABLE INCL. CABLE MANAGEMENT CENTER OR PREPARED FOR TABLE SCREENS | 4 LEGS

12 mm tabletop in MDF with linoleum or 10 mm tabletop in MDF with veneer. Incl. 40 mm cable management cover or prepared for table screens. Tabletop is placed inside the table frame. 4 legs incl. adjustable gliders. Requires assembly. Table screens and STEP modules not included.

Order produced

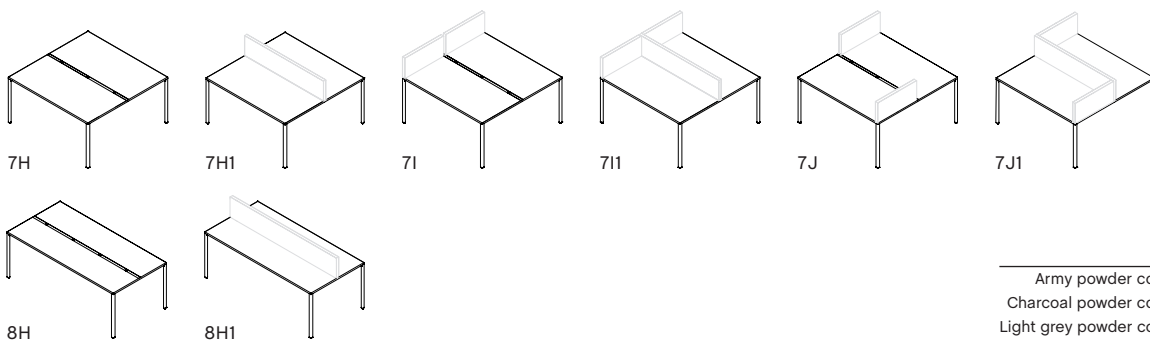

FRAME & LEGS		TABLETOP				
Army powder coated aluminium		Cloud grey linoleum	Dark grey linoleum	Green linoleum	Grey linoleum	Water-based lacquered oak veneer
Charcoal powder coated aluminium		•	•	•	•	
Light grey powder coated aluminium		•	•	•	•	

VARIANT	DIMENSION	BOX DIMENSION WEIGHT	PACKAGING	PRICE
7H	L150 x W150 x H74 cm L59.06 x W59.06 x 29.13"	W160 x D42 x H16 cm 21 kg W164 x D89 x H9 cm 48 kg W75 x D27 x H8 cm 11 kg	3 box 1 pcs.	21.600,00
7H1	L150 x W150 x H74 cm L59.06 x W59.06 x 29.13"	W160 x D42 x H16 cm 21 kg W164 x D89 x H9 cm 48 kg W75 x D27 x H8 cm 11 kg	3 box 1 pcs.	21.600,00
7I	L150 x W150 x H74 cm L59.06 x W59.06 x 29.13"	W160 x D42 x H16 cm 21 kg W164 x D89 x H9 cm 48 kg W75 x D27 x H8 cm 11 kg	3 box 1 pcs.	27.100,00
7I1	L150 x W150 x H74 cm L59.06 x W59.06 x 29.13"	W160 x D42 x H16 cm 21 kg W164 x D89 x H9 cm 48 kg W75 x D27 x H8 cm 11 kg	3 box 1 pcs.	27.100,00
7J	L150 x W150 x H74 cm L59.06 x W59.06 x 29.13"	W160 x D42 x H16 cm 21 kg W164 x D89 x H9 cm 48 kg W75 x D27 x H8 cm 11 kg	3 box 1 pcs.	27.100,00
7J1	L150 x W150 x H74 cm L59.06 x W59.06 x 29.13"	W160 x D42 x H16 cm 21 kg W164 x D89 x H9 cm 48 kg W75 x D27 x H8 cm 11 kg	3 box 1 pcs.	27.100,00
8H	L200 x W100 x H74 cm L78.74" x W39.37" x 29.13"	W75 x D27 x H8 cm 11 kg W202 x D42 x H14,5 cm 16 kg W214 x D114 x H4,5 cm 32 kg	3 box 1 pcs.	21.400,00
8H1	L200 x W100 x H74 cm L78.74" x W39.37" x 29.13"	W75 x D27 x H8 cm 11 kg W202 x D42 x H14,5 cm 16 kg W214 x D114 x H4,5 cm 32 kg	3 box 1 pcs.	21.400,00

22% rabatt ska dras av på angivna priser
OBS. Prislista inkl. moms

TABLE INCL. CABLE MANAGEMENT CENTER OR PREPARED FOR TABLE SCREENS | 4 LEGS

12 mm tabletop in MDF with linoleum or 10 mm tabletop in MDF with veneer. Incl. 40 mm cable management cover or prepared for table screens. Tabletop is placed inside the table frame. 4 legs incl. adjustable gliders. Requires assembly. Table screens and STEP modules not included.

Order produced

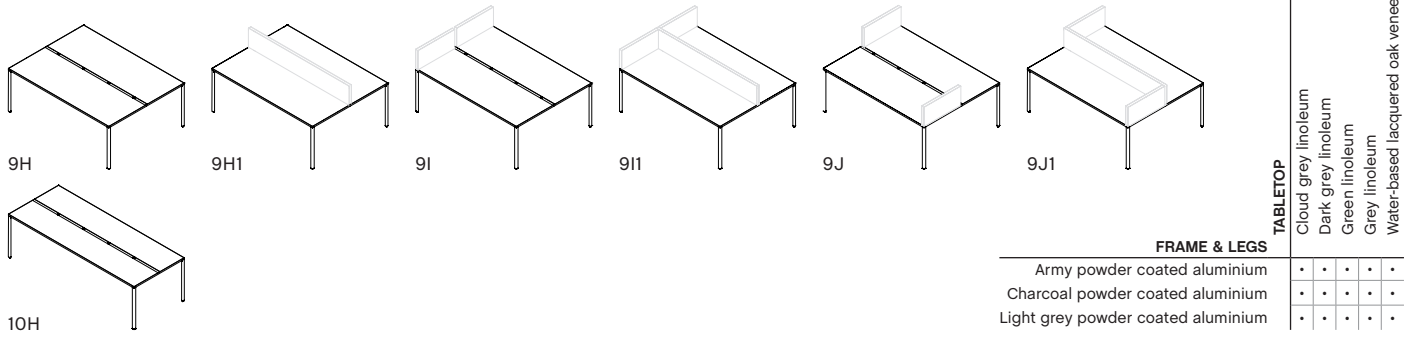

VARIANT	DIMENSION	BOX DIMENSION WEIGHT	PACKAGING	PRICE
9H	L200 x W150 x H74 cm L78.74" x W150 x H74 cm	W252 x D42 x H16 cm 22 kg W214 x D89 x H9 cm 38 kg W75 x D27 x H8 cm 6 kg	3 box 1 pcs.	24.400,00
9H1	L200 x W150 x H74 cm L78.74" x W150 x H74 cm	W252 x D42 x H16 cm 22 kg W214 x D89 x H9 cm 38 kg W75 x D27 x H8 cm 6 kg	3 box 1 pcs.	24.400,00
9I	L200 x W150 x H74 cm L78.74" x W150 x H74 cm	W252 x D42 x H16 cm 22 kg W214 x D89 x H9 cm 38 kg W75 x D27 x H8 cm 6 kg	3 box 1 pcs.	30.650,00
9I1	L200 x W150 x H74 cm L78.74" x W150 x H74 cm	W252 x D42 x H16 cm 22 kg W214 x D89 x H9 cm 38 kg W75 x D27 x H8 cm 6 kg	3 box 1 pcs.	30.650,00
9J	L200 x W150 x H74 cm L78.74" x W150 x H74 cm	W252 x D42 x H16 cm 22 kg W214 x D89 x H9 cm 38 kg W75 x D27 x H8 cm 6 kg	3 box 1 pcs.	30.650,00
9J1	L200 x W150 x H74 cm L78.74" x W150 x H74 cm	W252 x D42 x H16 cm 22 kg W214 x D89 x H9 cm 38 kg W75 x D27 x H8 cm 6 kg	3 box 1 pcs.	30.650,00
10H	L250 x W100 x H74 cm L98.43" x W39.37" x 29.13"	W252 x D42 x H16 cm 20 kg W264 x D114 x H4,5 cm 38 kg W75 x D27 x H8 cm 6 kg	3 box 1 pcs.	27.800,00

TABLE INCL. PLUG & PLAY CABLE MANAGEMENT CENTER OR PREPARED FOR TABLE SCREENS | 4 LEGS

12 mm tabletop in MDF with linoleum or 10 mm tabletop in MDF with veneer. Incl. 80 mm plug & play cable management cover or prepared for table screens. Tabletop is placed inside the table frame. 4 legs incl. adjustable gliders. Requires assembly. Table screens and STEP modules not included.

Order produced

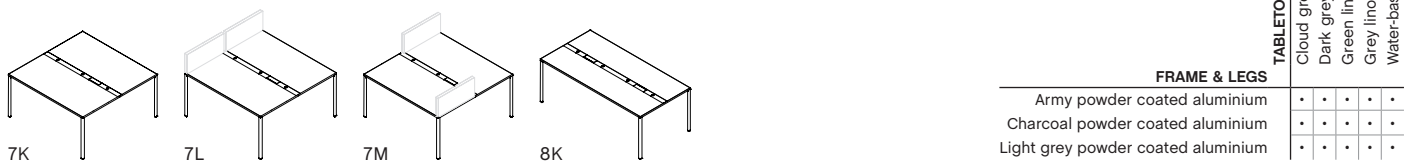

VARIANT	DIMENSION	BOX DIMENSION WEIGHT	PACKAGING	PRICE
7K	L150 x W150 x H74 cm L59.06 x W59.06 x 29.13"	W252 x D42 x H16 cm 22 kg W214 x D89 x H9 cm 38 kg W75 x D27 x H8 cm 6 kg	3 box 1 pcs.	26.300,00
7L	L150 x W150 x H74 cm L59.06 x W59.06 x 29.13"	W252 x D42 x H16 cm 22 kg W214 x D89 x H9 cm 38 kg W75 x D27 x H8 cm 6 kg	3 box 1 pcs.	28.650,00
7M	L150 x W150 x H74 cm L59.06 x W59.06 x 29.13"	W252 x D42 x H16 cm 22 kg W214 x D89 x H9 cm 38 kg W75 x D27 x H8 cm 6 kg	3 box 1 pcs.	28.650,00
8K	L250 x W100 x H74 cm L98.43" x W39.37" x 29.13"	W252 x D42 x H16 cm 20 kg W264 x D114 x H4,5 cm 38 kg W75 x D27 x H8 cm 6 kg	3 box 1 pcs.	26.900,00

22% rabatt ska dras av på angivna priser
OBS. Prislista inkl. moms

**TABLE INCL. PLUG & PLAY CABLE MANAGEMENT CENTER
 OR PREPARED FOR TABLE SCREENS | 4 LEGS**

12 mm tabletop in MDF with linoleum or 10 mm tabletop in MDF with veneer. Incl. 80 mm plug & play cable management cover or prepared for table screens. Tabletop is placed inside the table frame. 4 legs incl. adjustable gliders. Requires assembly. Table screens and STEP modules not included.

Order produced

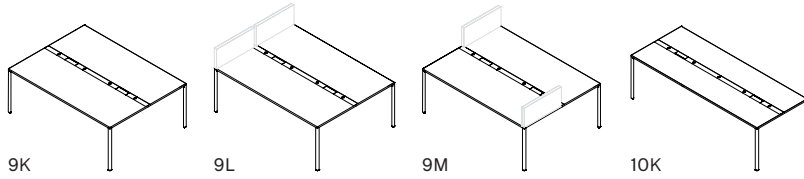

FRAME & LEGS		TABLETOP			
Army powder coated aluminium		Cloud grey linoleum			
Charcoal powder coated aluminium		Dark grey linoleum			
Light grey powder coated aluminium		Green linoleum			
		Grey linoleum			
		Water-based lacquered oak veneer			

VARIANT	DIMENSION	BOX DIMENSION WEIGHT	PACKAGING	PRICE
9K	L200 x W150 x H74 cm L78.74" x W150 x H74 cm	W202 x D42 x H14,5 cm 16 kg W75 x D27 x H8 cm 6 kg W214 x D114 x H4,5 cm 32 kg	3 box 1 pcs.	29.900,00
9L	L200 x W150 x H74 cm L78.74" x W150 x H74 cm	W202 x D42 x H14,5 cm 16 kg W75 x D27 x H8 cm 6 kg W214 x D114 x H4,5 cm 32 kg	3 box 1 pcs.	32.250,00
9M	L200 x W150 x H74 cm L78.74" x W150 x H74 cm	W160 x D42 x H16 cm 21 kg W164 x D89 x H9 cm 48 kg W75 x D27 x H8 cm 11 kg	3 box 1 pcs.	32.250,00
10K	L150 x W150 x H74 cm L59.06 x W59.06 x 29.13"	W202 x D42 x H14,5 cm 16 kg W75 x D27 x H8 cm 6 kg W214 x D114 x H4,5 cm 32 kg	3 box 1 pcs.	34.100,00

**TABLE INCL. DOUBLE PLUG & PLAY CABLE MANAGEMENT
 CENTER IN COMBINATION WITH TABLE SCREENS | 4 LEGS**

12 mm tabletop in MDF with linoleum or 10 mm tabletop in MDF with veneer. Incl. 80 mm plug & play cable management cover and prepared for table screens. Tabletop is placed inside the table frame. 4 legs incl. adjustable gliders. Requires assembly. Table screens and STEP modules not included.

Order produced

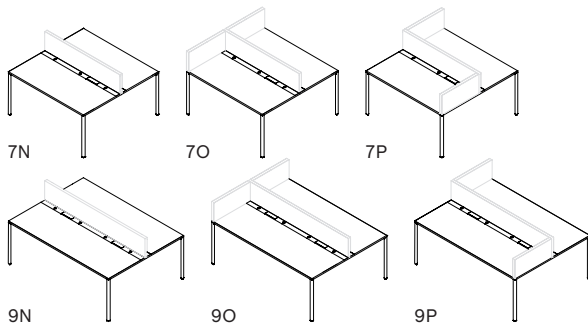

FRAME & LEGS		TABLETOP			
Army powder coated aluminium		Cloud grey linoleum			
Charcoal powder coated aluminium		Dark grey linoleum			
Light grey powder coated aluminium		Green linoleum			
		Grey linoleum			
		Water-based lacquered oak veneer			

VARIANT	DIMENSION	BOX DIMENSION WEIGHT	PACKAGING	PRICE
7N	L150 x W150 x H74 cm L59.06 x W59.06 x 29.13"	W160 x D42 x H16 cm 21 kg W164 x D89 x H9 cm 48 kg W75 x D27 x H8 cm 11 kg	3 box 1 pcs.	27.850,00
7O	L150 x W150 x H74 cm L59.06 x W59.06 x 29.13"	W160 x D42 x H16 cm 21 kg W164 x D89 x H9 cm 48 kg W75 x D27 x H8 cm 11 kg	3 box 1 pcs.	30.250,00
7P	L150 x W150 x H74 cm L59.06 x W59.06 x 29.13"	W160 x D42 x H16 cm 21 kg W164 x D89 x H9 cm 48 kg W75 x D27 x H8 cm 11 kg	3 box 1 pcs.	30.250,00
9N	L150 x W150 x H74 cm L59.06 x W59.06 x 29.13"	W202 x D42 x H14,5 cm 16 kg W75 x D27 x H8 cm 6 kg W214 x D114 x H4,5 cm 32 kg	3 box 1 pcs.	30.800,00
9O	L200 x W150 x H74 cm L78.74" x W150 x H74 cm	W252 x D42 x H16 cm 22 kg W214 x D89 x H9 cm 38 kg W75 x D27 x H8 cm 6 kg	3 box 1 pcs.	33.150,00
9P	L200 x W150 x H74 cm L78.74" x W150 x H74 cm	W252 x D42 x H16 cm 22 kg W214 x D89 x H9 cm 38 kg W75 x D27 x H8 cm 6 kg	3 box 1 pcs.	33.150,00

22% rabatt ska dras av på angivna priser
OBS. Prislista inkl. moms

TABLE SCREEN EDGE | 58 | 73

Wood structure with MDF panels, 3 mm foam layer upholstered with textile. Incl. integrated brackets for mounting on the frame. Table screen edge can be mounted on tables in width 150 cm. Table screen edge 58 to be used in combination with top tray dividers.

Order produced



VARIANT	DIMENSION	BOX DIMENSION WEIGHT	PACKAGING	FABRIC	PRICE
W58	W58 x D5 x H75 W22.83" x D1.97" x H29.53"	1 pcs. W58 x D5 x H33 3.6 kg	1 box 1 pcs.	Remix	4.550,00
				Surface By HAY	4.550,00
				Steelcut	5.000,00
				Steelcut Trio	5.000,00
Canvas	5.150,00				

VARIANT	DIMENSION	BOX DIMENSION WEIGHT	PACKAGING	FABRIC	PRICE
W73	W73 x D4 x H33 W28.74" x D1.57" x H12.99"	1 pcs. W73 x D4 x H33 4.3 kg	1 box 1 pcs.	Remix	4.550,00
				Surface By HAY	4.550,00
				Steelcut	5.000,00
				Steelcut Trio	5.000,00
Canvas	5.150,00				

TABLE SCREEN MIDDLE | 100 | 150 | 200

Wood structure with MDF panels, 3 mm foam layer upholstered with textile. Incl. integrated brackets for mounting into the frame. Table screen middle is mounted on the support bar.

Order produced



VARIANT	DIMENSION	BOX DIMENSION WEIGHT	PACKAGING	FABRIC	PRICE
W100	W100 x D4 x H33 W39.37" x D1.57" x H12.99"	1 pcs. W100 x D4 x H33 5.5 kg	1 box 1 pcs.	Remix	4.550,00
				Surface By HAY	4.550,00
				Steelcut	5.000,00
				Steelcut Trio	5.000,00
Canvas	5.150,00				

VARIANT	DIMENSION	BOX DIMENSION WEIGHT	PACKAGING	FABRIC	PRICE
W150	W150 x D4 x H33 W59.06" x D1.57" x H12.99"	1 pcs. W150 x D4 x H33 7.2 kg	1 box 1 pcs.	Remix	6.100,00
				Surface By HAY	6.100,00
				Steelcut	6.750,00
				Steelcut Trio	6.750,00
Canvas	6.900,00				

VARIANT	DIMENSION	BOX DIMENSION WEIGHT	PACKAGING	FABRIC	PRICE
W200	W200 x D4 x H33 W78.74" x D1.57" x H12.99"	1 pcs. W200 x D4 x H33 10.8 kg	1 box 1 pcs.	Remix	8.450,00
				Surface By HAY	8.450,00
				Steelcut	9.100,00
				Steelcut Trio	9.100,00
Canvas	9.250,00				

22% rabatt ska dras av på angivna priser OBS. Pristista inkl. moms

TABLE LEGS

Powder coated extruded aluminium. Incl. adjustable gliders.

Stock item

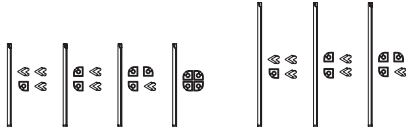

MATERIAL	COLOUR		
	Army	Charcoal	Light grey
Powder coated extruded aluminium	•	•	•

VARIANT	BOX DIMENSION WEIGHT	PACKAGING	PRICE
H74 SET OF 1	1 pcs. W79 x D27 x H8 7.5 kg	1 box 1 pcs.	2.500,00
H74 SET OF 2	1 pcs. W79 x D27 x H8 8.5 kg	1 box 1 pcs.	3.450,00
H74 SET OF 3	1 pcs. W79 x D27 x H8 10 kg	1 box 1 pcs.	4.400,00
H74 SET OF 4	1 pcs. W79 x D27 x H8 11 kg	1 box 1 pcs.	5.300,00
H110 SET OF 1	1 pcs. W115 x D27 x H8 11 kg	1 box 1 pcs.	2.660,00
H110 SET OF 2	1 pcs. W115 x D27 x H8 13 kg	1 box 1 pcs.	3.750,00
H110 SET OF 3	1 pcs. W115 x D27 x H8 15 kg	1 box 1 pcs.	4.850,00

DOUBLE TABLE LEGS

Powder coated extruded aluminium. Incl. adjustable gliders.

Stock item

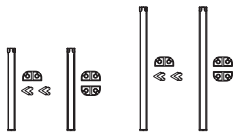

MATERIAL	COLOUR		
	Army	Charcoal	Light grey
Powder coated extruded aluminium	•	•	•

VARIANT	BOX DIMENSION WEIGHT	PACKAGING	PRICE
H74 SET OF 1	1 pcs. W79 x D27 x H8 8.5 kg	1 box 1 pcs.	3.450,00
H74 SET OF 2	1 pcs. W79 x D27 x H8 11 kg	1 box 1 pcs.	5.300,00
H110 SET OF 1	1 pcs. W115 x D27 x H8 13 kg	1 box 1 pcs.	3.750,00
H110 SET OF 2	1 pcs. W115 x D27 x H8 X kg	1 box 1 pcs.	5.950,00

22% rabatt ska dras av på angivna priser
OBS. Pristista inkl. moms

TABLE CONNECTORS

Powder coated steel

Stock item

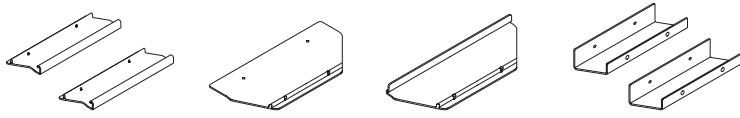

MATERIAL	COLOUR		
	Army	Charcoal	Light grey
Powder coated steel	•	•	•

VARIANT	BOX DIMENSION WEIGHT	PACKAGING	PRICE
FRONT SET OF 2	1 pcs. W26.5 x D15 x H7.5 0.5 kg	1 box 1 pcs.	300,00
END SHELF	1 pcs. W28 x D10 x H1.5 0.25 kg	1 box 1 pcs.	300,00
END TRAY	1 pcs. W28 x D13.5 x H1.5 0.25 kg	1 box 1 pcs.	300,00
WALL SET OF 2	1 pcs. W26 x D15.5 x H7.5 0.7 kg	1 box 1 pcs.	790,00

CABLE CLIP | SET OF 2

Black PP plastic. To be mounted in the frame channel underneath the table or in a support bar to hold cables. Max. 3 standard cables.

Stock item

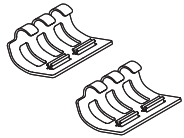

MATERIAL	COLOUR
	Black
PP Plastic	•

VARIANT	DIMENSION	BOX DIMENSION WEIGHT	PACKAGING	PRICE
SET OF 2	W6 x D4 x H3 W2.36" x D1.57" x H1.18"	1 pcs. W6.5 x D4.5 x H3.5 0.05 kg	1 box 1 pcs.	49,00

CABLE GUIDE FOR TABLE LEG | H74

ABS plastic. Recommended for maximum 3 standard cables.

Stock item

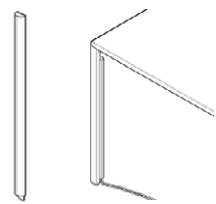

MATERIAL	COLOUR		
	Army	Charcoal	Light grey
ABS Plastic	•	•	•

VARIANT	DIMENSION	BOX DIMENSION WEIGHT	PACKAGING	PRICE
H74	W3,30 x D2,2 x H64 cm W1,3" x D0,87" x H25,2"	1 pcs. W3,30 x D2,2 x H64 cm 0,05 kg	1 box 1 pcs.	49,00

22% rabatt ska dras av på angivna priser
OBS. Prislista inkl. moms

HIGH TABLE HT-5 | H90 CM

12 mm tabletop in MDF with linoleum or 10 mm tabletop in MDF with veneer.
Tabletop is placed inside the table frame. 4 legs in two heights incl. adjustable gliders. STEP modules not included. Requires assembly.

Order produced



FRAME & LEGS	TABLETOP			
	Army powder coated aluminium	Cloud grey linoleum	Dark grey linoleum	Green linoleum
Charcoal powder coated aluminium	•	•	•	•
Light grey powder coated aluminium	•	•	•	•

VARIANT	DIMENSION	BOX DIMENSION WEIGHT	PACKAGING	PRICE
HT90-5A	L150 x W75 x H90 cm L59.06" x W29.53" x 35.43"	W163 x D88,5 x H2,5 cm 14,6 kg W160 X D85 X H8 cm 12 kg W115 x D27 x H8 cm 16 kg W163 x D42 x H16 cm 9 kg	4 box 1 pcs.	22.500,00
HT90-5F CABLEM. EDGE	L150 x W75 x H90 cm L59.06" x W29.53" x 35.43"	W163 x D88,5 x H2,5 cm 14,6 kg W160 X D85 X H8 cm 12 kg W115 x D27 x H8 cm 16 kg W163 x D42 x H16 cm 17 kg	4 box 1 pcs.	27.200,00
HT90-5G PLUG & PLAY CABLEM. EDGE	L150 x W75 x H90 cm L59.06" x W29.53" x 35.43"	W163 x D88,5 x H2,5 cm 14,6 kg W160 X D85 X H8 cm 12 kg W115 x D27 x H8 cm 16 kg W163 x D42 x H16 cm 12 kg	4 box 1 pcs.	28.750,00

HIGH TABLE HT-12 | H90 CM

12 mm tabletop in MDF with linoleum or 10 mm tabletop in MDF with veneer.
Tabletop is placed inside the table frame. 4 legs in two heights incl. adjustable gliders. STEP modules not included. Requires assembly.

Order produced

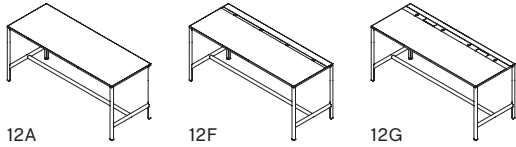

FRAME & LEGS	TABLETOP			
	Army powder coated aluminium	Cloud grey linoleum	Dark grey linoleum	Green linoleum
Charcoal powder coated aluminium	•	•	•	•
Light grey powder coated aluminium	•	•	•	•

VARIANT	DIMENSION	BOX DIMENSION WEIGHT	PACKAGING	PRICE
HT90-12A	L200 x W75 x H90 cm L78.74" x W29.53" x 35.43"	W213,5 x D88,5 x H2,5 cm 19,1 kg W210 x D85 x H8 cm 15 kg W115 x D27 x H8 cm 16 kg W210 x D42 x H16 cm 15 kg	4 box 1 pcs.	24.850,00
HT90-12F CABLEM. EDGE	L200 x W75 x H90 cm L78.74" x W29.53" x 35.43"	W213,5 x D88,5 x H2,5 cm 19,1 kg W210 x D85 x H8 cm 15 kg W115 x D27 x H8 cm 16 kg W210 x D42 x H16 cm 17 kg	4 box 1 pcs.	30.600,00
HT90-12G PLUG & PLAY CABLEM. EDGE	L200 x W75 x H90 cm L78.74" x W29.53" x 35.43"	W213,5 x D88,5 x H2,5 cm 19,1 kg W210 x D85 x H8 cm 15 kg W115 x D27 x H8 cm 16 kg W210 x D42 x H16 cm 17,5 kg	4 box 1 pcs.	32.200,00

22% rabatt ska dras av på angivna priser
OBS. Prislista inkl. moms

HIGH TABLE HT-6 | H90 CM

12 mm tabletop in MDF with linoleum or 10 mm tabletop in MDF with veneer.
Tabletop is placed inside the table frame. 4 legs in two heights incl. adjustable gliders. STEP modules not included. Requires assembly.

Order produced

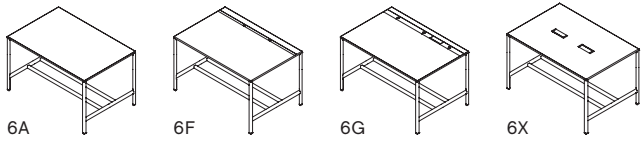

FRAME & LEGS	TABLETOP			
Army powder coated aluminium	Cloud grey linoleum	Dark grey linoleum	Green linoleum	Grey linoleum
Charcoal powder coated aluminium	•	•	•	•
Light grey powder coated aluminium	•	•	•	•
	Water-based lacquered oak veneer			

VARIANT	DIMENSION	BOX DIMENSION WEIGHT	PACKAGING	PRICE
HT90-6A	L150 x W100 x H90 cm L59.06" x W39.37" x 35.43"	W163 x D113,5 x H2,5 cm 19,3 kg W160 x D110 x H8 cm 13 kg W115 x D27 x H8 cm 16 kg W163 x D42 x H16 cm 14 kg	4 box 1 pcs.	22.350,00
HT90-6F CABLEM. EDGE	L150 x W100 x H90 cm L59.06" x W39.37" x 35.43"	W163 x D113,5 x H2,5 cm 19,3 kg W160 x D110 x H8 cm 13 kg W115 x D27 x H8 cm 16 kg W163 x D42 x H16 cm 16 kg	4 box 1 pcs.	27.050,00
HT90-6G PLUG & PLAY CABLEM. EDGE	L150 x W100 x H90 cm L59.06" x W39.37" x 35.43"	W163 x D113,5 x H2,5 cm 19,3 kg W160 x D110 x H8 cm 13 kg W115 x D27 x H8 cm 16 kg W163 x D42 x H16 cm 14,5 kg	4 box 1 pcs.	28.600,00
HT90-6X SINGLE PLUG & PLAY X 2 CENTER	L150 x W100 x H90 cm L59.06" x W39.37" x 35.43"	W163 x D113,5 x H2,5 cm 19,3 kg W160 x D110 x H8 cm 13 kg W115 x D27 x H8 cm 16 kg W163 x D42 x H16 cm 14 kg	4 box 1 pcs.	28.600,00

HIGH TABLE HT-3 | H90 CM

12 mm tabletop in MDF with linoleum or 10 mm tabletop in MDF with veneer.
Tabletop is placed inside the table frame. 4 legs in two heights incl. adjustable gliders. STEP modules, top tray and single profiles not included. Requires assembly.

Order produced

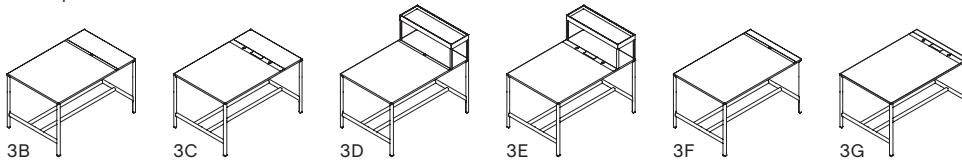

FRAME & LEGS	TABLETOP			
Army powder coated aluminium	Cloud grey linoleum	Dark grey linoleum	Green linoleum	Grey linoleum
Charcoal powder coated aluminium	•	•	•	•
Light grey powder coated aluminium	•	•	•	•
	Water-based lacquered oak veneer			

VARIANT	DIMENSION	BOX DIMENSION WEIGHT	PACKAGING	PRICE
HT90-3B CABLEM. EDGE 34 CM	L100 x W150 x H90 cm L39.37" x W59.06" x 35.43"	W163 x D113,5 x H2,5 cm 19,3 kg W160 x D110 x H8 cm 13 kg W115 x D27 x H8 cm 16 kg W163 x D42 x H16 cm 13 kg	4 box 1 pcs.	25.000,00
HT90-3C PLUG & PLAY CABLEM. EDGE 34 CM	L100 x W150 x H90 cm L39.37" x W59.06" x 35.43"	W163 x D113,5 x H2,5 cm 19,3 kg W160 x D110 x H8 cm 13 kg W115 x D27 x H8 cm 16 kg W163 x D42 x H16 cm 12 kg	4 box 1 pcs.	27.050,00
HT90-3D CABLEM. EDGE 34 CM + TRAY DIVIDER	L100 x W150 x H90 cm L39.37" x W59.06" x 35.43"	W163 x D113,5 x H2,5 cm 19,3 kg W160 x D110 x H8 cm 13 kg W115 x D27 x H8 cm 16 kg W163 x D42 x H16 cm 13 kg	4 box 1 pcs.	25.800,00
HT90-3E PLUG & PLAY CABLEM. EDGE 34 CM + TRAY DIVIDER	L100 x W150 x H90 cm L39.37" x W59.06" x 35.43"	W163 x D113,5 x H2,5 cm 19,3 kg W160 x D110 x H8 cm 13 kg W115 x D27 x H8 cm 16 kg W163 x D42 x H16 cm 12 kg	4 box 1 pcs.	27.800,00
HT90-3F CABLEM. EDGE	L100 x W150 x H90 cm L39.37" x W59.06" x 35.43"	W163 x D113,5 x H2,5 cm 19,3 kg W160 x D110 x H8 cm 13 kg W115 x D27 x H8 cm 16 kg W163 x D42 x H16 cm 13 kg	4 box 1 pcs.	25.000,00
HT90-3G PLUG & PLAY CABLEM. EDGE	L100 x W150 x H90 cm L39.37" x W59.06" x 35.43"	W163 x D113,5 x H2,5 cm 19,3 kg W160 x D110 x H8 cm 13 kg W115 x D27 x H8 cm 16 kg W163 x D42 x H16 cm 12 kg	4 box 1 pcs.	27.050,00

22% rabatt ska dras av på angivna priser
OBS. Prislista inkl. moms

HIGH TABLE HT-8 | H90 CM

12 mm tabletop in MDF with linoleum or 10 mm tabletop in MDF with veneer.
Tabletop is placed inside the table frame. 4 legs in two heights incl. adjustable gliders. STEP modules not included. Requires assembly.

Order produced

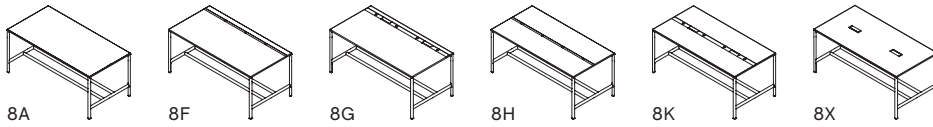

FRAME & LEGS	TABLETOP				
	Army powder coated aluminium	Cloud grey linoleum	Dark grey linoleum	Green linoleum	Grey linoleum
Charcoal powder coated aluminium	•	•	•	•	•
Light grey powder coated aluminium	•	•	•	•	•

VARIANT	DIMENSION	BOX DIMENSION WEIGHT	PACKAGING	PRICE
HT90-8A	L200 x W100 x H90 cm L78.74" x W39.37" x 35.43"	W213,5 x D113,5 x H2,5 cm 25,6 kg W210 x D110 x H8 cm 16 kg W115 x D27 x H8 cm 16 kg W213 x D42 x H16 cm 18 kg	4 box 1 pcs.	25.150,00
HT90-8F CABLEM. EDGE	L200 x W100 x H90 cm L78.74" x W39.37" x 35.43"	W213,5 x D113,5 x H2,5 cm 25,6 kg W210 x D110 x H8 cm 16 kg W115 x D27 x H8 cm 16 kg W213 x D42 x H16 cm 19,5 kg	4 box 1 pcs.	27.000,00
HT90-8G PLUG & PLAY CABLEM. EDGE	L200 x W100 x H90 cm L78.74" x W39.37" x 35.43"	W213,5 x D113,5 x H2,5 cm 25,6 kg W210 x D110 x H8 cm 16 kg W115 x D27 x H8 cm 16 kg W213 x D42 x H16 cm 19,5 kg	4 box 1 pcs.	32.500,00
HT90-8H CABLEM. CENTER	L200 x W100 x H90 cm L78.74" x W39.37" x 35.43"	W213,5 x D113,5 x H2,5 cm 25,6 kg W210 x D110 x H8 cm 16 kg W115 x D27 x H8 cm 16 kg W213 x D42 x H16 cm 16 kg	4 box 1 pcs.	27.000,00
HT90-8K PLUG & PLAY CABLEM. CENTER	L200 x W100 x H90 cm L78.74" x W39.37" x 35.43"	W213,5 x D113,5 x H2,5 cm 25,6 kg W210 x D110 x H8 cm 16 kg W115 x D27 x H8 cm 16 kg W213 x D42 x H16 cm 22 kg	4 box 1 pcs.	32.500,00
HT90-8X SINGLE PLUG & PLAY X 2 CENTER	L200 x W100 x H90 cm L78.74" x W39.37" x 35.43"	W213,5 x D113,5 x H2,5 cm 25,6 kg W210 x D110 x H8 cm 16 kg W115 x D27 x H8 cm 16 kg W213 x D42 x H16 cm 19 kg	4 box 1 pcs.	32.500,00

HIGH TABLE HT-5 | H105 CM

12 mm tabletop in MDF with linoleum or 10 mm tabletop in MDF with veneer.
Tabletop is placed inside the table frame. 4 legs in two heights incl. adjustable gliders. STEP modules not included. Requires assembly.

Order produced

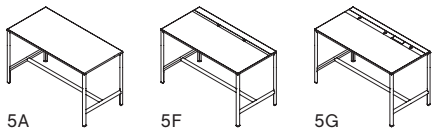

FRAME & LEGS	TABLETOP				
	Army powder coated aluminium	Cloud grey linoleum	Dark grey linoleum	Green linoleum	Grey linoleum
Charcoal powder coated aluminium	•	•	•	•	•
Light grey powder coated aluminium	•	•	•	•	•

VARIANT	DIMENSION	BOX DIMENSION WEIGHT	PACKAGING	PRICE
HT105-5A	L150 x W75 x H105 cm L59.06" x W29.53" x 41.34"	W163 x D88,5 x H2,5 cm 14,6 kg W160 x D85 x H8 cm 12 kg W115 x D27 x H8 cm 17 kg W213 x D42 x H16 cm 9 kg	4 box 1 pcs.	22.650,00
HT105-5F CABLEM. EDGE	L150 x W75 x H105 cm L59.06" x W29.53" x 41.34"	W163 x D88,5 x H2,5 cm 14,6 kg W160 x D85 x H8 cm 12 kg W115 x D27 x H8 cm 17 kg W213 x D42 x H16 cm 17 kg	4 box 1 pcs.	27.350,00
HT105-5G PLUG & PLAY CABLEM. EDGE	L150 x W75 x H105 cm L59.06" x W29.53" x 41.34"	W163 x D88,5 x H2,5 cm 14,6 kg W160 x D85 x H8 cm 12 kg W115 x D27 x H8 cm 17 kg W213 x D42 x H16 cm 12 kg	4 box 1 pcs.	28.900,00

22% rabatt ska dras av på angivna priser
OBS. Prislista inkl. moms

HIGH TABLE HT-12 | H105 CM

12 mm tabletop in MDF with linoleum or 10 mm tabletop in MDF with veneer. Tabletop is placed inside the table frame. 4 legs in two heights incl. adjustable gliders. STEP modules not included. Requires assembly.

Order produced

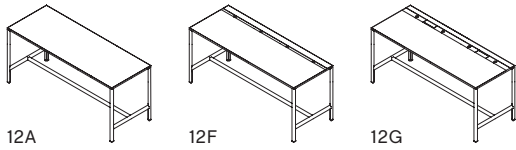

FRAME & LEGS	TABLETOP			
	Army powder coated aluminium	Cloud grey linoleum	Dark grey linoleum	Green linoleum
Charcoal powder coated aluminium	•	•	•	•
Light grey powder coated aluminium	•	•	•	•

VARIANT	DIMENSION	BOX DIMENSION WEIGHT	PACKAGING	PRICE
HT105-12A	L200 x W75 x H105 cm L78.74" x W29.53" x 41.34"	W213,5 x D88,5 x H2,5 cm 19,1 kg W210 x D85 x H8 cm 15 kg W115 x D27 x H8 cm 16 kg W210 x D42 x H16 cm 16 kg	4 box 1 pcs.	25.000,00
HT105-12F CABLEM. EDGE	L200 x W75 x H105 cm L78.74" x W29.53" x 41.34"	W213,5 x D88,5 x H2,5 cm 19,1 kg W210 x D85 x H8 cm 15 kg W115 x D27 x H8 cm 16 kg W210 x D42 x H16 cm 17 kg	4 box 1 pcs.	30.750,00
HT105-12G PLUG & PLAY CABLEM. EDGE	L200 x W75 x H105 cm L78.74" x W29.53" x 41.34"	W213,5 x D88,5 x H2,5 cm 19,1 kg W210 x D85 x H8 cm 15 kg W115 x D27 x H8 cm 16,17,5 kg	4 box 1 pcs.	32.350,00

HIGH TABLE HT-6 | H105 CM

12 mm tabletop in MDF with linoleum or 10 mm tabletop in MDF with veneer. Tabletop is placed inside the table frame. 4 legs in two heights incl. adjustable gliders. STEP modules not included. Requires assembly.

Order produced

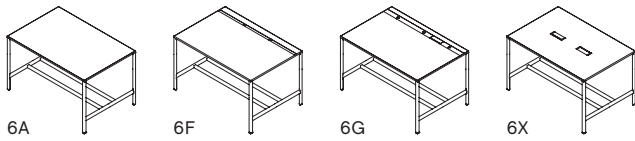

FRAME & LEGS	TABLETOP			
	Army powder coated aluminium	Cloud grey linoleum	Dark grey linoleum	Green linoleum
Charcoal powder coated aluminium	•	•	•	•
Light grey powder coated aluminium	•	•	•	•

VARIANT	DIMENSION	BOX DIMENSION WEIGHT	PACKAGING	PRICE
HT105-6A	L150 x W100 x H105 cm L59.06" x W39.37" x 41.34"	W163 x D113,5 x H2,5 cm 19,3 kg W160 x D110 x H8 cm 13 kg W115 x D27 x H8 cm 16 kg W163 x D42 x H16 cm 19,3 kg	4 box 1 pcs.	22.500,00
HT105-6F CABLEM. EDGE	L150 x W100 x H105 cm L59.06" x W39.37" x 41.34"	W163 x D113,5 x H2,5 cm 19,3 kg W160 x D110 x H8 cm 13 kg W115 x D27 x H8 cm 16 kg W163 x D42 x H16 cm 16 kg	4 box 1 pcs.	27.200,00
HT105-6G PLUG & PLAY CABLEM. EDGE	L150 x W100 x H105 cm L59.06" x W39.37" x 41.34"	W163 x D113,5 x H2,5 cm 19,3 kg W160 x D110 x H8 cm 13 kg W115 x D27 x H8 cm 16 kg W163 x D42 x H16 cm 14,5 kg	4 box 1 pcs.	28.750,00
HT105-6X SINGLE PLUG & PLAY X 2 CENTER	L150 x W100 x H105 cm L59.06" x W39.37" x 41.34"	W163 x D113,5 x H2,5 cm 19,3 kg W160 x D110 x H8 cm 13 kg W115 x D27 x H8 cm 16 kg W163 x D42 x H16 cm 14 kg	4 box 1 pcs.	28.750,00

22% rabatt ska dras av på angivna priser
OBS. Prislista inkl. moms

HIGH TABLE HT-3 | H105 CM

12 mm tabletop in MDF with linoleum or 10 mm tabletop in MDF with veneer.
Tabletop is placed inside the table frame. 4 legs in two heights incl. adjustable
gliders. STEP modules, top tray and single profiles not included. Requires assembly.

Order produced

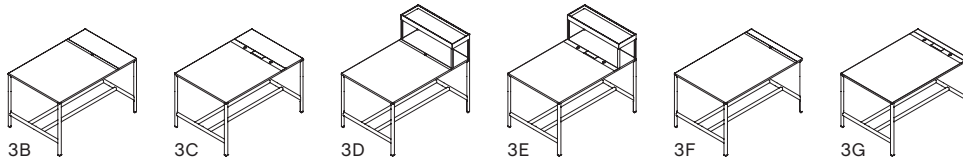

FRAME & LEGS	TABLETOP			
	Army powder coated aluminium	Cloud grey linoleum	Dark grey linoleum	Green linoleum
Charcoal powder coated aluminium	•	•	•	•
Light grey powder coated aluminium	•	•	•	•

VARIANT	DIMENSION	BOX DIMENSION WEIGHT	PACKAGING	PRICE
HT105-3B CABLEM. EDGE 34 CM	L100 x W150 x H105 cm L39.37" x W59.06" x 41.34"	W163 x D113,5 x H2,5 cm 19,3 kg W160 x D110 x H8 cm 13 kg W115 x D27 x H8 cm 16 kg W163 x D42 x H16 cm 13 kg	4 box 1 pcs.	25.150,00
HT105-3C PLUG & PLAY CABLEM. EDGE 34 CM	L100 x W150 x H105 cm L39.37" x W59.06" x 41.34"	W163 x D113,5 x H2,5 cm 19,3 kg W160 x D110 x H8 cm 13 kg W115 x D27 x H8 cm 16 kg W163 x D42 x H16 cm 12 kg	4 box 1 pcs.	27.200,00
HT105-3D CABLEM. EDGE 34 CM + TRAY DIVIDER	L100 x W150 x H105 cm L39.37" x W59.06" x 41.34"	W163 x D113,5 x H2,5 cm 19,3 kg W160 x D110 x H8 cm 13 kg W115 x D27 x H8 cm 16 kg W163 x D42 x H16 cm 13 kg	4 box 1 pcs.	25.950,00
HT105-3E PLUG & PLAY CABLEM. EDGE 34 CM + TRAY DIVIDER	L100 x W150 x H105 cm L39.37" x W59.06" x 41.34"	W163 x D113,5 x H2,5 cm 19,3 kg W160 x D110 x H8 cm 13 kg W115 x D27 x H8 cm 16 kg W163 x D42 x H16 cm 12 kg	4 box 1 pcs.	27.950,00
HT105-3F CABLEM. EDGE	L100 x W150 x H105 cm L39.37" x W59.06" x 41.34"	W163 x D113,5 x H2,5 cm 19,3 kg W160 x D110 x H8 cm 13 kg W115 x D27 x H8 cm 16 kg W163 x D42 x H16 cm 13 kg	4 box 1 pcs.	25.150,00
HT105-3G PLUG & PLAY CABLEM. EDGE	L100 x W150 x H105 cm L39.37" x W59.06" x 41.34"	W163 x D113,5 x H2,5 cm 19,3 kg W160 x D110 x H8 cm 13 kg W115 x D27 x H8 cm 16 kg W163 x D42 x H16 cm 12 kg	4 box 1 pcs.	27.200,00

22% rabatt ska dras av på angivna priser
OBS. Prislista inkl. moms

HIGH TABLE HT-8 | H105 CM

12 mm tabletop in MDF with linoleum or 10 mm tabletop in MDF with veneer. Tabletop is placed inside the table frame. 4 legs in two heights incl. adjustable gliders. STEP modules not included. Requires assembly.

Order produced

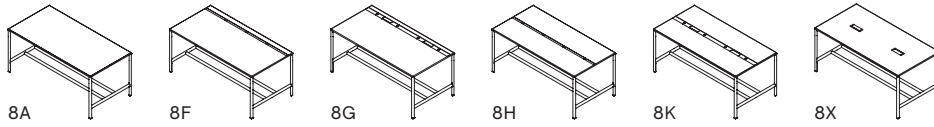

FRAME & LEGS	TABLETOP			
	Army powder coated aluminium	Cloud grey linoleum	Dark grey linoleum	Green linoleum
Charcoal powder coated aluminium	•	•	•	•
Light grey powder coated aluminium	•	•	•	•

VARIANT	DIMENSION	BOX DIMENSION WEIGHT	PACKAGING	PRICE
HT105-8A	L200 x W100 x H105 cm L78.74" x W39.37" x 41.34"	W213,5 x D113,5 x H2,5 cm 25,6 kg W210 x D110 x H8 cm 16 kg W115 x D27 x H8 cm 16 kg W213 x D42 x H16 cm 18 kg	4 box 1 pcs.	25.300,00
HT105-8F CABLEM. EDGE	L200 x W100 x H105 cm L78.74" x W39.37" x 41.34"	W213,5 x D113,5 x H2,5 cm 25,6 kg W210 x D110 x H8 cm 16 kg W115 x D27 x H8 cm 16 kg W213 x D42 x H16 cm 19,5 kg	4 box 1 pcs.	27.150,00
HT105-8G PLUG & PLAY CABLEM. EDGE	L200 x W100 x H105 cm L78.74" x W39.37" x 41.34"	W213,5 x D113,5 x H2,5 cm 25,6 kg W210 x D110 x H8 cm 16 kg W115 x D27 x H8 cm 16 kg W213 x D42 x H16 cm 19,5 kg	4 box 1 pcs.	32.650,00
HT105-8H CABLEM. CENTER	L200 x W100 x H105 cm L78.74" x W39.37" x 41.34"	W213,5 x D113,5 x H2,5 cm 25,6 kg W210 x D110 x H8 cm 16 kg W115 x D27 x H8 cm 16 kg W213 x D42 x H16 cm 16 kg	4 box 1 pcs.	27.150,00
HT105-8K PLUG & PLAY CABLEM. CENTER	L200 x W100 x H105 cm L78.74" x W39.37" x 41.34"	W213,5 x D113,5 x H2,5 cm 25,6 kg W210 x D110 x H8 cm 16 kg W115 x D27 x H8 cm 16 kg W213 x D42 x H16 cm 22 kg	4 box 1 pcs.	32.650,00
HT105-8X SINGLE PLUG & PLAY X 2 CENTER	L200 x W100 x H105 cm L78.74" x W39.37" x 41.34"	W213,5 x D113,5 x H2,5 cm 25,6 kg W210 x D110 x H8 cm 16 kg W115 x D27 x H8 cm 16 kg W213 x D42 x H16 cm 19 kg	4 box 1 pcs.	32.650,00

22% rabatt ska dras av på angivna priser
OBS. Prislista inkl. moms

CABLE TRAY | 35

Powder coated steel.

Stock item

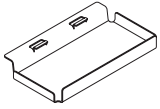

MATERIAL	COLOUR
Powder coated steel	Charcoal

VARIANT	DIMENSION	BOX DIMENSION WEIGHT	PACKAGING	PRICE
W35	W35 x D21 x H4,2 W13.78" x D8.27" x H1.65"	1 pcs. W38 x D23 x H6 1 kg	1 box 1 pcs.	500,00

CABLE TRAY FOR STEP MODULE | 35

Powder coated steel. Prepared for STEP Module.

Stock item

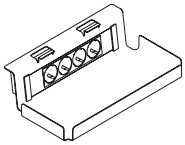

MATERIAL	COLOUR
Powder coated steel	Army Charcoal Light grey

VARIANT	DIMENSION	BOX DIMENSION WEIGHT	PACKAGING	PRICE
W35	W35 x D21 x H7 W13.78" x D8.27" x H2.76"	1 pcs. W38 x D23 x H9 1.2 kg	1 box 1 pcs.	630,00

22% rabatt ska dras av på angivna priser
OBS. Prislista inkl. moms

STEP MODULES FOR CABLE MANAGEMENT

STEP BASE in plastic and STEP ALU in aluminium. NO STEP module power strip profile with 3 or 4 outlets. Customer outlets CAT6 or HDMI are sold separately. The custom module fits two customer outlets. The STEP Module fits into NO support bar or cable tray prepared for STEP module.

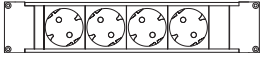
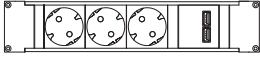
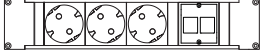

Stock item

	COLOUR
	Charcoal
	MATERIAL
	Powder coated steel

CEE/GE++ PLUG TYPE F	VARIANT	DIMENSION	BOX DIMENSION WEIGHT	PACKAGING	PRICE
	4 OUTLETS	W30 x D5,5 x H4,5 W11.81" x D2.17" x H1.77"	1 pcs. W32 x D7.5 x H6.5 0.35 kg1 box 1 pcs.	1 pcs.	790,00
	3 OUTLETS + 1 DOUBLE USB	W30 x D5,5 x H4,5 W11.81" x D2.17" x H1.77"	1 pcs. W32 x D7.5 x H6.5 0.35 kg1 box 1 pcs.	1 pcs.	1.250,00
	3 OUTLETS + 1 CUSTOMER MODULE W/2 OUTLET	W30 x D5,5 x H4,5 W11.81" x D2.17" x H1.77"	1 pcs. W32 x D7.5 x H6.5 0.35 kg1 box 1 pcs.	1 pcs.	870,00

PLUG TYPE F (CEE GE++)

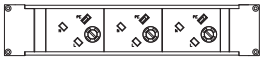
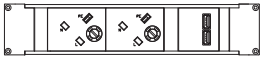
AD, AF, AL, AM, AN (CW, SX, BQ), AS, AT, AW, AZ, BA, BG, BT, BY, CV, DE, DK, DZ, EE, EG, ES, ET, FI, FO, GE, GL, GN, GR, HR, HU, ID, IS, IR, IT, JO, KG, KP, KR, KZ, LA, LR, LT, LU, LV, LY, MC, MD, ME, MF, MK, MM, MO, MZ, NC, NE, NL, NO, PT, RO, RS, RU, SE, SI, SM, SR, ST, TD, TH, TJ, TL, TM, TR, UA, UY, VN

UK++ PLUG TYPE G	VARIANT	DIMENSION	BOX DIMENSION WEIGHT	PACKAGING	PRICE
	3 OUTLES	W30 x D5,5 x H4,5 W11.81" x D2.17" x H1.77"	1 pcs. W32 x D7.5 x H6.5 0.35 kg1 box 1 pcs.	1 pcs.	790,00
	2 OUTLETS + 1 DOUBLE USB	W30 x D5,5 x H4,5 W11.81" x D2.17" x H1.77"	1 pcs. W32 x D7.5 x H6.5 0.35 kg1 box 1 pcs.	1 pcs.	1.250,00
	2 OUTLETS + 1 CUSTOMER MODULE W/2 OUTLET	W30 x D5,5 x H4,5 W11.81" x D2.17" x H1.77"	1 pcs. W32 x D7.5 x H6.5 0.35 kg1 box 1 pcs.	1 pcs.	870,00

PLUG TYPE G (UK++)

AE, BD, BH, BN, BT, BW, BZ, CY, DM, FK, GB, GD, GH, GI, GM, GY, HK, IE, IM, IQ, JO, KE, KH, KN, KW, LB, LC, LK, MM, MO, MT, MU, MV, MW, MY, NG, OM, PK, QA, SA, SB, SC, SG, SL, TZ, UG, VC, VU, YE, ZM, ZW

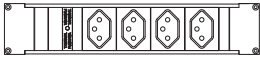
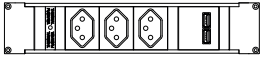
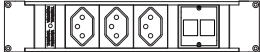
CH++ PLUG TYPE J	VARIANT	DIMENSION	BOX DIMENSION WEIGHT	PACKAGING	PRICE
	4 OUTLETS	W30 x D5,5 x H4,5 W11.81" x D2.17" x H1.77"	1 pcs. W32 x D7.5 x H6.5 0.35 kg1 box 1 pcs.	1 pcs.	790,00
	3 OUTLETS + 1 DOUBLE USB	W30 x D5,5 x H4,5 W11.81" x D2.17" x H1.77"	1 pcs. W32 x D7.5 x H6.5 0.35 kg1 box 1 pcs.	1 pcs.	1.250,00
	3 OUTLETS + 1 CUSTOMER MODULE W/2 OUTLET	W30 x D5,5 x H4,5 W11.81" x D2.17" x H1.77"	1 pcs. W32 x D7.5 x H6.5 0.35 kg1 box 1 pcs.	1 pcs.	870,00

PLUG TYPE J (CH++)

CH, JO, LI, MG, MV, RW

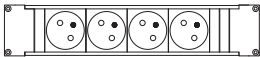
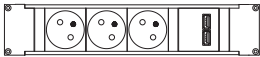
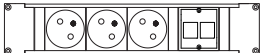
FR++ PLUG TYPE E	VARIANT	DIMENSION	BOX DIMENSION WEIGHT	PACKAGING	PRICE
	4 OUTLETS	W30 x D5,5 x H4,5 W11.81" x D2.17" x H1.77"	1 pcs. W32 x D7.5 x H6.5 0.35 kg1 box 1 pcs.	1 pcs.	790,00
	3 OUTLETS + 1 DOUBLE USB	W30 x D5,5 x H4,5 W11.81" x D2.17" x H1.77"	1 pcs. W32 x D7.5 x H6.5 0.35 kg1 box 1 pcs.	1 pcs.	1.250,00
	3 OUTLETS + 1 CUSTOMER MODULE W/2 OUTLET	W30 x D5,5 x H4,5 W11.81" x D2.17" x H1.77"	1 pcs. W32 x D7.5 x H6.5 0.35 kg1 box 1 pcs.	1 pcs.	870,00

PLUG TYPE E (FR++)

BE, BF, BI, BJ, CD, CF, CG, CI, CM, CZ, DK, DJ, ET, FO, FR, GF, GL, GP, GQ, KM, LA, LR, MA, MC, MG, ML, MN, MQ, NE, PL, RE, SK, SN, SY, TD, TL, TN, VC

22% rabatt ska dras av på angivna priser
OBS. Prislista inkl. moms

STEP MODULES FOR CABLE MANAGEMENT

STEP BASE in plastic and STEP ALU in aluminium. NO STEP module power strip profile with 3 or 4 outlets. Customer outlets CAT6 or HDMI are sold separately. The custom module fits two customer outlets. The STEP Module fits into NO support bar or cable tray prepared for STEP module.

Stock item

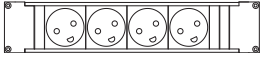
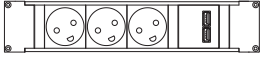
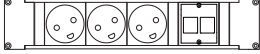
DK++ PLUG TYPE K	VARIANT	DIMENSION	BOX DIMENSION WEIGHT	PACKAGING	PRICE
	4 OUTLETS	W30 x D5,5 x H4,5 W11.81" x D2.17" x H1.77"	1 pcs. W32 x D7.5 x H6.5 0.35 kg1 box 1 pcs.		790,00
	3 OUTLETS + 1 DOUBLE USB	W30 x D5,5 x H4,5 W11.81" x D2.17" x H1.77"	1 pcs. W32 x D7.5 x H6.5 0.35 kg1 box 1 pcs.		1.250,00
	3 OUTLETS + 1 CUSTOMER MODULE W/2 OUTLET	W30 x D5,5 x H4,5 W11.81" x D2.17" x H1.77"	1 pcs. W32 x D7.5 x H6.5 0.35 kg1 box 1 pcs.		870,00

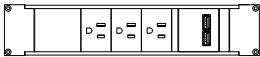
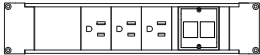

PLUG TYPE K (DK++)

BD, DK, FO, GL, GN, MG, MV, SN, VC

US++ PLUG TYPE A	VARIANT	DIMENSION	BOX DIMENSION WEIGHT	PACKAGING	PRICE
	4 OUTLETS	W30 x D5,5 x H4,5 W11.81" x D2.17" x H1.77"	1 pcs. W32 x D7.5 x H6.5 0.35 kg1 box 1 pcs.		790,00
	3 OUTLETS + 1 DOUBLE USB	W30 x D5,5 x H4,5 W11.81" x D2.17" x H1.77"	1 pcs. W32 x D7.5 x H6.5 0.35 kg1 box 1 pcs.		1.250,00
	3 OUTLETS + 1 CUSTOMER MODULE W/2 OUTLET	W30 x D5,5 x H4,5 W11.81" x D2.17" x H1.77"	1 pcs. W32 x D7.5 x H6.5 0.35 kg1 box 1 pcs.		870,00

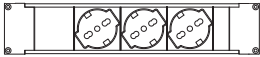
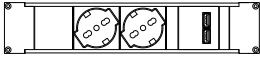

PLUG TYPE A (US++)

AG, AI, AN (CW, SX, BQ), AS, AW, BB, BM, BO, BS, BZ, CA, CN, CO, CR, CU, DO, EC, FM, GT, GU, GY, HN, HT, JM, JP, KH, KN, KP, KY, LA, LB, LR, SV, MS, MV, MX, MY, NE, NI, PA, PE, PH, PR, PW, TC, TH, TT, TW, US, VC, VE, VG, VI, VN, YE

IT++ PLUG TYPE L	VARIANT	DIMENSION	BOX DIMENSION WEIGHT	PACKAGING	PRICE
	3 OUTLETS	W30 x D5,5 x H4,5 W11.81" x D2.17" x H1.77"	1 pcs. W32 x D7.5 x H6.5 0.35 kg1 box 1 pcs.		790,00
	2 OUTLETS + 1 DOUBLE USB	W30 x D5,5 x H4,5 W11.81" x D2.17" x H1.77"	1 pcs. W32 x D7.5 x H6.5 0.35 kg1 box 1 pcs.		1.250,00
	2 OUTLETS + 1 CUSTOMER MODULE W/2 OUTLET	W30 x D5,5 x H4,5 W11.81" x D2.17" x H1.77"	1 pcs. W32 x D7.5 x H6.5 0.35 kg1 box 1 pcs.		870,00

PLUG TYPE L (IT++)

CL, ER, ET, IT, MV, SM, SY, UY

ALL COUNTRIES	VARIANT	DIMENSION	BOX DIMENSION WEIGHT	PACKAGING	PRICE
	CUSTOMER OUTLET CAT6	W2,5 x D5,5 x H4,5 W0.98" x D2.17" x H1.77"	1 pcs. W4.5 x D7.5 x H6.5 0.1 kg 1 box 1 pcs.		630,00
	CUSTOMER OUTLET HDMI	W2,5 x D5,5 x H4,5 W0.98" x D2.17" x H1.77"	1 pcs. W4.5 x D7.5 x H6.5 0.1 kg 1 box 1 pcs.		630,00

22% rabatt ska dras av på angivna priser
OBS. Pristlista inkl. moms

STEP MODULE EXTENSION CABLE

L200 cm

Stock item

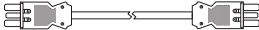
EXTENSION CABLE	VARIANT	DIMENSION	BOX DIMENSION WEIGHT	PACKAGING	PRICE
	ALL COUNTRIES	W25 x D5 x H5 W9.84" x D1.97" x H1.97"	1 pcs. W27 x D7 x H7 0.5 kg	1 box 1 pcs.	300,00

STEP MODULES SUPPLY CABLES

L500 cm

Stock item

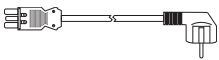
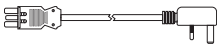
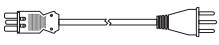
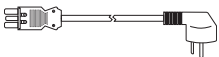
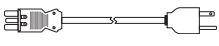
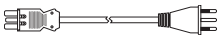
EXTENSION CABLE	VARIANT	DIMENSION	BOX DIMENSION WEIGHT	PACKAGING	PRICE
	TYPE E (FR++) / TYPE F (CEE/GE++)	W25 x D5 x H5 W9.84" x D1.97" x H1.97"	1 pcs. W27 x D7 x H7 0.5 kg	1 box 1 pcs.	439,00
	TYPE G (UK++)	W25 x D5 x H5 W9.84" x D1.97" x H1.97"	1 pcs. W27 x D7 x H7 0.5 kg	1 box 1 pcs.	439,00
	TYPE J (CH++)	W25 x D5 x H5 W9.84" x D1.97" x H1.97"	1 pcs. W27 x D7 x H7 0.5 kg	1 box 1 pcs.	439,00
	TYPE K (DK++)	W25 x D5 x H5 W9.84" x D1.97" x H1.97"	1 pcs. W27 x D7 x H7 0.5 kg	1 box 1 pcs.	439,00
	TYPE A (US++)	W25 x D5 x H5 W9.84" x D1.97" x H1.97"	1 pcs. W27 x D7 x H7 0.5 kg	1 box 1 pcs.	1.400,00
	TYPE L (IT++)	W25 x D5 x H5 W9.84" x D1.97" x H1.97"	1 pcs. W27 x D7 x H7 0.5 kg	1 box 1 pcs.	439,00

22% rabatt ska dras av på angivna priser
OBS. Prislista inkl. moms

COVER FOR CABLE MANAGEMENT W. PEN HOLDER | MODULE SIZE 50 CM

Powder coated aluminium

Stock item

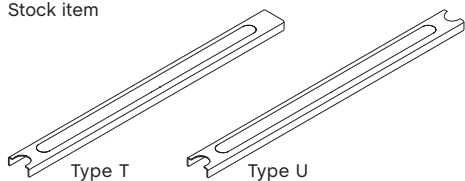

MATERIAL	COLOUR		
	Army	Charcoal	Light grey
Powder coated aluminium	•	•	•

VARIANT	DIMENSION	BOX DIMENSION WEIGHT	PACKAGING	PRICE
END - TYPE T	W50 x D4 x H1 W19.69" x D1.57" x H0.39"	1 pcs. W52 x D42 x H3 0.4 kg	1 box 1 pcs.	130,00
MIDDLE - TYPE U	W50 x D4 x H1 W19.69" x D1.57" x H0.39"	1 pcs. W52 x D42 x H3 0.41 kg	1 box 1 pcs.	130,00

COVER FOR CABLE MANAGEMENT | MODULE SIZE 25 CM

Powder coated aluminium

Stock item

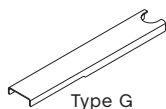

MATERIAL	COLOUR		
	Army	Charcoal	Light grey
Powder coated aluminium	•	•	•

VARIANT	DIMENSION	BOX DIMENSION WEIGHT	PACKAGING	PRICE
END - TYPE G	W25 x D4 x H1 W9.84" x D1.57" x H0.39"	1 pcs. W27 x D42 x H3 0.1 kg	1 box 1 pcs.	219,00

COVER FOR CABLE MANAGEMENT | MODULE SIZE 50 CM

Powder coated aluminium

Stock item

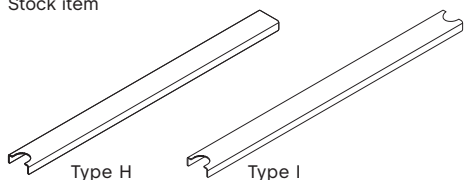

MATERIAL	COLOUR		
	Army	Charcoal	Light grey
Powder coated aluminium	•	•	•

VARIANT	DIMENSION	BOX DIMENSION WEIGHT	PACKAGING	PRICE
END - TYPE H	W50 x D4 x H1 W19.69" x D1.57" x H0.39"	1 pcs. W52 x D42 x H3 0.18 kg	1 box 1 pcs.	219,00
MIDDLE - TYPE I	W50 x D4 x H1 W19.69" x D1.57" x H0.39"	1 pcs. W52 x D42 x H3 0.6 kg	1 box 1 pcs.	219,00

COVER FOR PLUG AND PLAY | DOUBLE P&P CABLE MANAGEMENT | MODULE SIZE 25 CM

Powder coated aluminium

Stock item

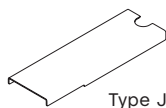

MATERIAL	COLOUR		
	Army	Charcoal	Light grey
Powder coated aluminium	•	•	•

VARIANT	DIMENSION	BOX DIMENSION WEIGHT	PACKAGING	PRICE
END - TYPE J	W25 x D8 x H1 W9.84" x D3.15" x H0.39"	1 pcs. W27 x D82 x H3 0.2 kg	1 box 1 pcs.	299,00

22% rabatt ska dras av på angivna priser
OBS. Prislista inkl. moms

**COVER FOR PLUG AND PLAY | DOUBLE P&P CABLE MANAGEMENT |
 MODULE SIZE 50 CM**

Powder coated aluminium

Stock item

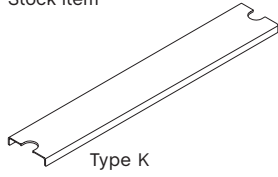

MATERIAL	COLOUR		
	Army	Charcoal	Light grey
Powder coated aluminium	•	•	•

VARIANT	DIMENSION	BOX DIMENSION WEIGHT	PACKAGING	PRICE
MIDDLE - TYPE K	W50 x D8 x H1 W19.69" x D3.15" x H0.39"	1 pcs. W52 x D82 x H3 0.4 kg	1 box 1 pcs.	369,00

**FLIP COVER FOR PLUG AND PLAY | DOUBLE P&P CABLE MANAGEMENT |
 MODULE SIZE 50 CM | MIDDLE**

Powder coated aluminium

Stock item

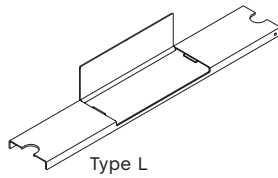

MATERIAL	COLOUR		
	Army	Charcoal	Light grey
Powder coated aluminium	•	•	•

VARIANT	DIMENSION	BOX DIMENSION WEIGHT	PACKAGING	PRICE
MIDDLE - TYPE L	W50 x D8 x H1 W19.69" x D3.15" x H0.39"	1 pcs. W52 x D82 x H3 0.4 kg	1 box 1 pcs.	630,00

22% rabatt ska dras av på angivna priser
OBS. Pristista inkl. moms

NO COMBINATION 101

ITEM LIST

- 1 x NO Shelf Bottom 100 cm
- 1 x NO Tray Top 100 cm
- 1 x NO Single Profile | Set of 4
- 1 x NO Wheels 34 mm Black | Set of 4

Stock item

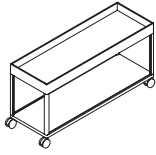

MATERIAL	COLOUR			
	Army	Charcoal	Light grey	Red
Powder coated aluminium	•	•	•	•

VARIANT

W100

DIMENSION

W100 x D34 x H49,9 cm
W39.37" x D13.39" x H19.65"

PRICE

5.380,00

NO COMBINATION 102

ITEM LIST

- 1 x NO Tray Top 150 cm
- 1 x NO Shelf Bottom 150 cm
- 1 x NO Single Profile | Set of 4
- 1 x NO Wheels 34 mm Black | Set of 4

Stock item

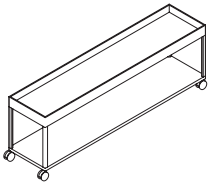

MATERIAL	COLOUR			
	Army	Charcoal	Light grey	Red
Powder coated aluminium	•	•	•	•

VARIANT

W150

DIMENSION

W150 x D34 x H49,9 cm
W59.06" x D13.39" x H19.65"

PRICE

7.090,00

NO COMBINATION 103

ITEM LIST

- 2 x NO Shelf Bottom 100 cm
- 2 x NO Tray Top 100 cm
- 1 x NO Single Profile | Set of 4
- 1 x NO Double Profile | Set of 2
- 2 x NO Wheels 34 mm Black | Set of 4

Stock item

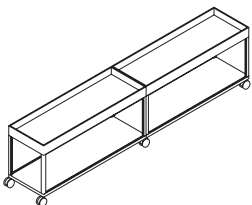

MATERIAL	COLOUR			
	Army	Charcoal	Light grey	Red
Powder coated aluminium	•	•	•	•

VARIANT

W200

DIMENSION

W200 x D34 x H49,9 cm
W78.74" x D13.39" x H19.65"

PRICE

10.760,00

22% rabatt ska dras av på angivna priser
OBS. Prislista inkl. moms

NO BENCH COMBINATION 100

ITEM LIST

- 1 x NO Shelf Top 100 cm
- 1 x NO Shelf Bottom 100 cm
- 1 x NO Single Profile | Set of 4
- 1 x NO Benchtop 100 cm

Order produced

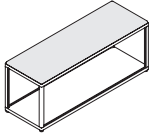

MATERIAL	COLOUR			
	Army	Charcoal	Light grey	Red
Powder coated aluminium	•	•	•	•

VARIANT	DIMENSION	FABRIC	PRICE
W100	W100 x D34 x H41,7 cm W39.37" x D13.39" x H16.42"	Remix	7.080,00
		Surface By HAY	7.080,00
		Steelcut	7.230,00
		Steelcut Trio	7.230,00
		Canvas	7.390,00
		Sierra black leather	7.530,00
		Sense cognac leather	8.650,00

NO BENCH COMBINATION 150

ITEM LIST

- 1 x NO Shelf Top 150 cm
- 1 x NO Shelf Bottom 150 cm
- 1 x NO Single Profile | Set of 4
- 1 x NO Benchtop 150 cm

Order produced

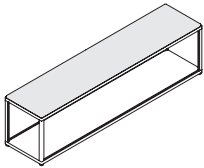

MATERIAL	COLOUR			
	Army	Charcoal	Light grey	Red
Powder coated aluminium	•	•	•	•

VARIANT	DIMENSION	FABRIC	PRICE
W150	W150 x D34 x H41,7 cm W59.06" x D13.39" x H16.42"	Remix	9.960,00
		Surface By HAY	9.960,00
		Steelcut	10.190,00
		Steelcut Trio	10.190,00
		Canvas	10.440,00
		Sierra black leather	10.660,00
		Sense cognac leather	12.090,00

22% rabatt ska dras av på angivna priser
OBS. Prislista inkl. moms

NO COMBINATION 201

ITEM LIST

- 1 x NO Shelf Top 100 cm
 - 1 x NO Shelf Middle 100 cm
 - 1 x NO Shelf Bottom 100 cm
 - 1 x NO Single Profile | Set of 4
 - 2 x NO Steel shelf 100 cm | Incl. pin 4 pcs. for adjustable side panels | Powder coated steel
 - 2 x NO Steel side panel double height 34 cm for adjustable shelf | Powder coated steel
 - 1 x NO Steel wall back panel double height 100 cm | Powder coated steel
 - 1 x NO Single Profile for double height | Set of 4
 - 1 x NO Steel sliding door double height 100 cm | Incl. handle, powder coated steel
- Please remember to specify wall- or floor safety brackets when ordering this combination.

Order produced

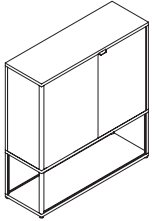

MATERIAL	COLOUR		
	Army	Charcoal	Light grey
Powder coated aluminium	•	•	•

VARIANT	DIMENSION	PRICE
W. WALL SAFETY BRACKET	W100 x D34 x H109,3 cm W39.37" x D13.39" x H43.03"	16.410,00
W. FLOOR SAFETY BRACKET	W100 x D34 x H109,3 cm W39.37" x D13.39" x H43.03"	16.660,00

NO COMBINATION 202

ITEM LIST

- 1 x NO Shelf Top 150 cm
- 1 x NO Shelf Middle 150 cm
- 1 x NO Shelf Bottom 150 cm
- 2 x NO Single Profile | Set of 4

Stock item

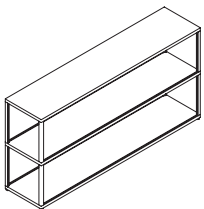

MATERIAL	COLOUR			
	Army	Charcoal	Light grey	Red
Powder coated aluminium	•	•	•	•

VARIANT	DIMENSION	PRICE
W150	W150 x D34 cm x H74 cm W59.06" x D13.39" x H29.13"	10.130,00

22% rabatt ska dras av på angivna priser
OBS. Pristista inkl. moms

NO COMBINATION 203

ITEM LIST

- 2 x NO Shelf Middle 100 cm
- 2 x NO Shelf Bottom 100 cm
- 2 x NO Tray Top 100 cm
- 2 x NO Single Profile | Set of 4
- 2 x NO Double Profile | Set of 2
- 4 x NO Steel side panel 34 cm | Powder coated steel
- 2 x NO Steel back panel 100 cm | Powder coated steel
- 2 x NO Steel sliding door 100 cm | Incl. handle, powder coated steel

Order produced

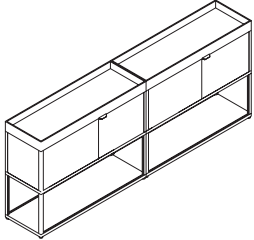

MATERIAL	COLOUR		
	Army	Charcoal	Light grey
Powder coated aluminium	•	•	•

VARIANT	DIMENSION	PRICE
W200	W200 x D34 x H79,7 cm W78.74" x D13.39" x H31.38"	22.880,00

NO COMBINATION 204

ITEM LIST

- 1 x NO Shelf Middle 100 cm
 - 1 x NO Shelf Bottom 100 cm
 - 1 x NO Tray Top 100 cm
 - 1 x NO Single Profile | Set of 4
 - 2 x NO Steel side panel double height 34 cm | For adjustable shelf powder coated steel
 - 1 x NO Steel back panel double height 100 cm | Powder coated steel
 - 1 x NO Single Profile for double height | Set of 4
 - 2 x NO Steel shelf 100 cm | Incl. pin 4 pcs. for adjustable side panels powder coated steel
 - 1 x NO Steel sliding door double height 100 cm | Incl. handle powder coated steel
- Please remember to specify wall- or floor safety brackets when ordering this combination.

Order produced

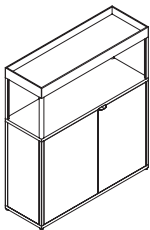

MATERIAL	COLOUR		
	Army	Charcoal	Light grey
Powder coated aluminium	•	•	•

VARIANT	DIMENSION	PRICE
W. WALL SAFETY BRACKET	W100 x D34 x H115 cm W39.37" x D13.39" x H45.28"	16.560,00
W. FLOOR SAFETY BRACKET	W100 x D34 x H115 cm W39.37" x D13.39" x H45.28"	16.810,00

22% rabatt ska dras av på angivna priser
OBS. Prislista inkl. moms

NO COMBINATION 205

ITEM LIST

- 1 x NO Shelf Top 100 cm
 - 1 x NO Shelf Middle 100 cm
 - 1 x NO Shelf Bottom 100 cm
 - 1 x NO High drawer incl. Mounting set 100 cm
 - 2 x NO Steel Side panel 34 cm
 - 1 x NO Steel Back panel 100 cm
 - 2 x NO Single profile | Set of 4
- Please remember to specify wall- or floor safety brackets when ordering this combination.

Order produced

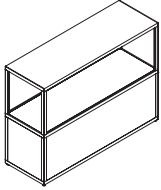

MATERIAL	COLOUR		
	Army	Charcoal	Light grey
Powder coated aluminium	•	•	•

VARIANT	DIMENSION	PRICE
W. WALL SAFETY BRACKET	W100 x D34 cm x H74 cm W39,37" x D13.39" x H29.13"	14.790,00
W. FLOOR SAFETY BRACKET	W100 x D34 cm x H74 cm W39,37" x D13.39" x H29.13"	16.830,00

NO COMBINATION 301

ITEM LIST

- 1 x NO Shelf Top 100 cm
 - 2 x NO Shelf Middle 100 cm
 - 1 x NO Shelf Bottom 100 cm
 - 3 x NO Single Profile | Set of 4
- Please remember to specify wall- or floor safety brackets when ordering this combination.

Stock item

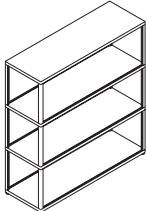

MATERIAL	COLOUR			
	Army	Charcoal	Light grey	Red
Powder coated aluminium	•	•	•	•

VARIANT	DIMENSION	PRICE
W. WALL SAFETY BRACKET	W100 x D34 x H109,3 cm W39.37" x D13.39" x H43.03"	10.200,00
W. FLOOR SAFETY BRACKET	W100 x D34 x H109,3 cm W39.37" x D13.39" x H43.03"	10.450,00

22% rabatt ska dras av på angivna priser
OBS. Prislista inkl. moms

NO COMBINATION 303

ITEM LIST

- 2 x NO Shelf Middle 100 cm
- 1 x NO Shelf Bottom 100 cm
- 1 x NO Tray Top 100 cm
- 3 x NO Single Profile | Set of 4

Please remember to specify wall- or floor safety brackets when ordering this combination.

Stock item

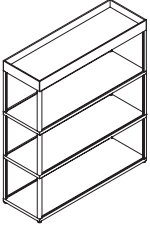

MATERIAL	COLOUR			
	Army	Charcoal	Light grey	Red
Powder coated aluminium	•	•	•	•

VARIANT	DIMENSION	PRICE
W. WALL SAFETY BRACKET	W100 x D34 x H115 cm W39.37" x D13.39" x H45.28"	10.350,00
W. FLOOR SAFETY BRACKET	W100 x D34 x H115 cm W39.37" x D13.39" x H45.28"	10.600,00

NO COMBINATION 401

ITEM LIST

- 1 x NO Wooden panel and door set incl. handle 100 cm
- 1 x NO Shelf Top 100 cm
- 3 x NO Shelf Middle 100 cm
- 1 x NO Shelf Bottom 100 cm
- 4 x NO Single Profile | Set of 4

Please remember to specify floor safety brackets when ordering this combination.

Order produced

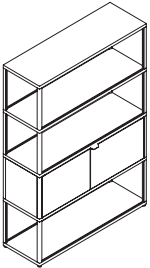

MATERIAL	COLOUR			
	Army	Charcoal	Light grey	Red
Powder coated aluminium	•	•	•	•

VARIANT	DIMENSION	PRICE
W. WALL SAFETY BRACKET	W100 x D34 x H144,6 cm W39.37" x D13.39" x H56.93"	15.940,00
W. FLOOR SAFETY BRACKET	W100 x D34 x H144,6 cm W39.37" x D13.39" x H56.93"	16.190,00

22% rabatt ska dras av på angivna priser
OBS. Prislista inkl. moms

NO COMBINATION 501

ITEM LIST

- 1 x NO Shelf Top 100 cm
- 4 x NO Shelf Middle 100 cm
- 1 x NO Shelf Bottom 100 cm
- 5 x NO Single Profile | Set of 4

Please remember to specify wall- or floor safety brackets when ordering this combination.

Stock item

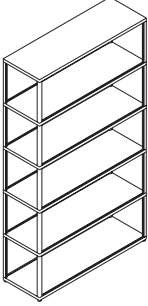

MATERIAL	COLOUR		
	Army	Charcoal	Light grey
Powder coated aluminium	•	•	•

VARIANT	DIMENSION	PRICE
W. WALL SAFETY BRACKET	W100 x D34 x H179,9 cm W39.37" x D13.39" x H70.83	15.420,00
W. FLOOR SAFETY BRACKET	W100 x D34 x H179,9 cm W39.37" x D13.39" x H70.83	15.670,00

NO COMBINATION 502

ITEM LIST

- 1 x NO Shelf Top 100 cm
 - 4 x NO Shelf Middle 100 cm
 - 1 x NO Shelf Bottom 100 cm
 - 5 x NO Single Profile | Set of 4
 - 2 x NO Steel side panel 34 cm | Powder coated steel
 - 1 x NO Steel back panel 100 cm | Powder coated steel
 - 1 x NO Steel sliding door 100 cm | Incl. handle powder coated steel
- Please remember to specify wall- or floor safety brackets when ordering this combination.

Order produced

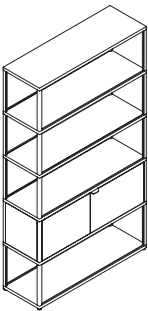

MATERIAL	COLOUR		
	Army	Charcoal	Light grey
Powder coated aluminium	•	•	•

VARIANT	DIMENSION	PRICE
W. WALL SAFETY BRACKET	W100 x D34 cm x H179,9 cm W39.37" x D13.39" x H70,83"	19.370,00
W. FLOOR SAFETY BRACKET	W100 x D34 cm x H179,9 cm W39.37" x D13.39" x H70,83"	19.620,00

22% rabatt ska dras av på angivna priser
OBS. Pristista inkl. moms

NO COMBINATION 701

ITEM LIST

- 1 x NO Shelf Top 100 cm
- 6 x NO Shelf Middle 100 cm
- 1 x NO Shelf Bottom 100 cm
- 7 x NO Single Profile | Set of 4

Please remember to specify wall- or floor safety brackets when ordering this combination.

Stock item

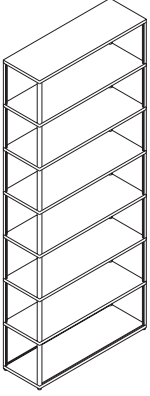

MATERIAL	COLOUR			
	Army	Charcoal	Light grey	Red
Powder coated aluminium	•	•	•	•

VARIANT	DIMENSION	PRICE
W. WALL SAFETY BRACKET	W100 x D34 x H250,5 cm W39.37" x D13.39" x H98.62"	20.640,00
W. FLOOR SAFETY BRACKET	W100 x D34 x H250,5 cm W39.37" x D13.39" x H98.62"	20.890,00

NO COMBINATION 702

ITEM LIST

- 1 x NO Shelf Top 150 cm
 - 6 x NO Shelf Middle 150 cm
 - 1 x NO Shelf Bottom 150 cm
 - 7 x NO Single Profile | Set of 4
 - 4 x NO Steel side panel 34 cm | Powder coated steel
 - 2 x NO Steel back panel 150 cm | Powder coated steel
 - 2 x NO Steel sliding door 150 cm | Incl. handle, powder coated steel
- Please remember to specify wall- or floor safety brackets when ordering this combination.

Order produced

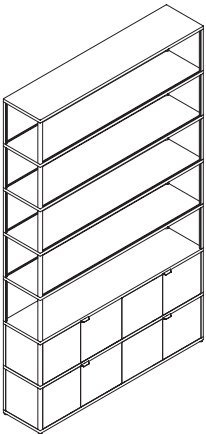

MATERIAL	COLOUR			
	Army	Charcoal	Light grey	Red
Powder coated aluminium	•	•	•	•

VARIANT	DIMENSION	PRICE
W. WALL SAFETY BRACKET	W150 x D34 x H250,5 cm W59.06" x D13.39" x H98.62"	39.460,00
W. FLOOR SAFETY BRACKET	W150 x D34 x H250,5 cm W59.06" x D13.39" x H98.62"	39.710,00

22% rabatt ska dras av på angivna priser
OBS. Prislista inkl. moms

NO TABLE COMBINATION 401

ITEM LIST

- 1 x NO Legs H74 Army | Set of 2 w. 2 flat knots
 - 1 x NO Table Connector Front 20 cm | Set of 2
 - 1 x NO Shelf Top 100 cm
 - 3 x NO Shelf Middle 100 cm
 - 1 x NO Shelf Bottom 100 cm
 - 3 x NO Single Profile | Set of 4
 - 2 x NO Steel side panel double height 34 cm | For adjustable shelf | Powder coated steel
 - 1 x NO Steel table back panel double height 100 cm | Powder coated steel
 - 1 x NO Single Profile for double height | Set of 4
 - 2 x NO Steel shelf 100 cm | Incl. pin 4 pcs. for adjustable side panels, powder coated steel
 - 1 x NO Steel sliding door double height 100 cm | Incl. handle, powder coated steel
 - 1 x NO Frame L100 x W100 F2
 - 1 x NO Tabletop 100x100 L994 x W994 B
- Please remember to specify wall- or floor safety brackets when ordering this combination.

Order produced

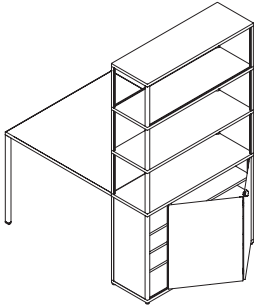

MATERIAL	COLOUR		
	Army	Charcoal	Light grey
Powder coated aluminium	•	•	•

VARIANT

W. FLOOR SAFETY
BRACKET

DIMENSION

W100 x D134 x H179,9 cm
W39.37" x D52.76" x H70.83"

PRICE

34.730,00

COLOURS & MATERIALS

SHELVING SYSTEM & TABLE FRAME

Powder-coated
aluminium & steel



ARMY

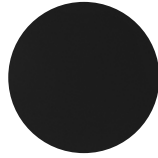

CHARCOAL



LIGHT GREY

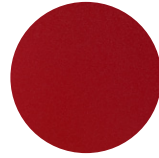

RED

*Not available for table
frame and steel

TABLETOPS

Linoleum



GREEN

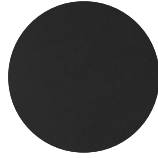

DARK GREY



GREY



CLOUD GREY

Veneer



WATER-BASED
LACQUERED OAK

WOODEN PANELS AND DOORS

Veneer



UNTREATED
OAK VENEER



UNTREATED
ASH VENEER

TEXTILE PANELS, TABLE SCREENS AND BENCHTOP

All textile colours
available from
each of the selected
collections

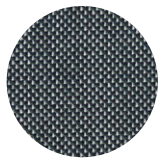

SURFACE
BY HAY

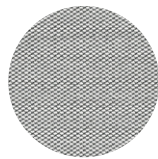

STEELCUT TRIO

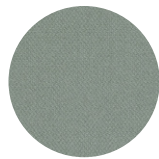

STEELCUT

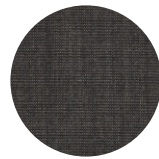

CANVAS

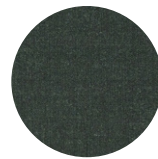

REMIX



LEATHER SENSE
COGNAC
(Benchtop only)



LEATHER SIERRA
BLACK S11001
(Benchtop only)