

24% rabatt ska dras av på angivna priser



Statligt ramavtal - Möbler och inredning

Delområde: Arbetsplats och förvaring

Dnr 23.3.-8004-18:056

Produktlista nr: 2

Arper

2023



24% rabatt ska dras av på angivna priser

Kontaktuppgifter

Lokala kontor och utställningar:

Stockholm

Regeringsgatan 66
103 88 Stockholm

Peter Almgren
076-533 50 43
peter.almgren@senab.com

Göteborg

Fiskhamnsgatan 6C
414 58 Göteborg

Anna Wennberg
076-533 51 44
anna.wennberg@senab.com

Malmö

Fersens väg 3
211 42 Malmö

Magdalena Andersson
076-535 75 87
magdalena.andersson@senab.com

Uppsala

Stationsgatan 32 C
753 40 Uppsala

Linnéa Hempel
076-195 39 86
linnea.hempel@senab.com

Helsingborg

Järnvägsgatan 57
252 18 Helsingborg

Christopher Lundin
076-533 50 02
christopher.lundin@senab.com

Umeå

Storgatan 41
903 25 Umeå

Patrik Karlsson
070 654 0066
patrik.karlsson@senab.com

Gävle

Nygatan 28
803 11 Gävle

Cecilia Sjöblom
076-501 10 93
cecilia.sjoblom@senab.com

Hedemora

Åsgatan 68
776 30 Hedemora

Michael Andersson
076-501 10 95
michael.andersson@senab.com

Edsbyn

Karls väg 2
828 25 Edsbyn

Ronny Fagerhov
070-224 67 44
ronny.fagerhov@senab.com

Jönköping

Västra Storgatan 19A
553 15 Jönköping

Pia Heldt
076-533 51 57
pia.heldt@senab.com

Sundsvall

Storgatan 4
852 30 Sundsvall

Jonas Westerlund
076-502 02 04
jonas.westerlund@senab.com

24% rabatt ska dras av på angivna priser

2023

PRICE LIST

Price list Sweden – SEK

arper

24% rabatt ska dras av på angivna priser

24% rabatt ska dras av på angivna priser

Product Certification



greenguard.org



geca.org.au



environdec.com



fsc.org

environment@arper.com

24% rabatt ska dras av på angivna priser

24% rabatt ska dras av på angivna priser

PANELS

24% rabatt ska dras av på angivna priser

Panels

Panels Arper Grade	Supplier	Collection	Upholstery Code	Program
A	Camira	Era	ER	Graded In
A	Camira	Phoenix	PH	Carded In
A	FiDiVi.	Jet	JE	Carded In
A	Gabriel	Fighter	FH	Graded In
B	Camira	Urban	UP	Carded In
B	Camira	Xtreme	XP	Graded In
B	Gabriel	Atlantic	AT	Graded In
B	Gabriel	Medley	MY	Graded In
B	Gabriel	Step	S1	Graded In
B	Gabriel	Step Melange	SM	Graded In
B	Kvadrat	Field 2	FI	Carded In
B	Kvadrat	Revive 1	R1	Carded In
C	Camira	Main Line Flax	MF	Carded In
C	Camira	Synergy	SN	Carded In
C	Gabriel	Fame	FA	Graded In
C	Kvadrat	Floyd	F1	Carded In
C	Kvadrat	Remix 3	RX	Carded In
D	Gabriel	Crisp	CR	Graded In
D	Kvadrat	Canvas 2	CV	Carded In
D	Kvadrat	Clara 2	CL	Graded In
D	Maharam	Messenger	MS	Carded In
E	Camira	Blazer	BL	Graded In
E	Kvadrat	Re-wool	RW	Carded In
F	Kvadrat	Fiord 2	FD	Carded In
F	Kvadrat	Tonus 4	T3	Carded In
G	Kvadrat	Divina 3	DV	Carded In
G	Kvadrat	Divina MD	DI	Carded In
G	Kvadrat	Divina Melange 3	DM	Carded In
G	Kvadrat	Jaali	JA	Carded In
G	Kvadrat	Savanna	SA	Graded In
G	Kvadrat	Steelcut 3	SE	Carded In
G	Kvadrat	Steelcut Trio 3	ST	Carded In
G (*)	Kvadrat	Hallingdal 65	HA	Carded In
I	Kvadrat	Balder 3	B1	Carded In
I	Kvadrat	Tonica 2	TN	Graded In
J	Kvadrat	Vidar 4	VD	Carded In
COM		COM	COM	

(*) The Hallingdal 65 fabric is suitable only for Parentesit Wall Collection

24% rabatt ska dras av på angivna priser

PARAVAN

Design by
Lievore Altherr
2018

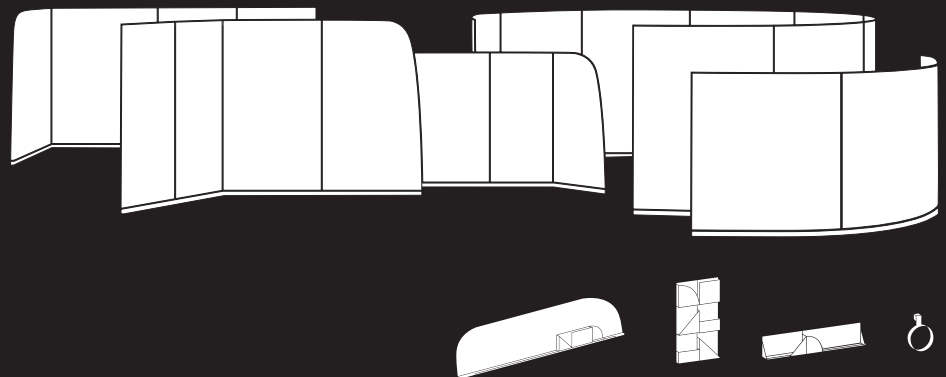

24% rabatt ska dras av på angivna priser

Paravan

Collection overview

(For more information please refer to User's Manual downloadable from our website)

Panels available in two heights — h 132,5 cm / 167,5 cm

Rectangular panels

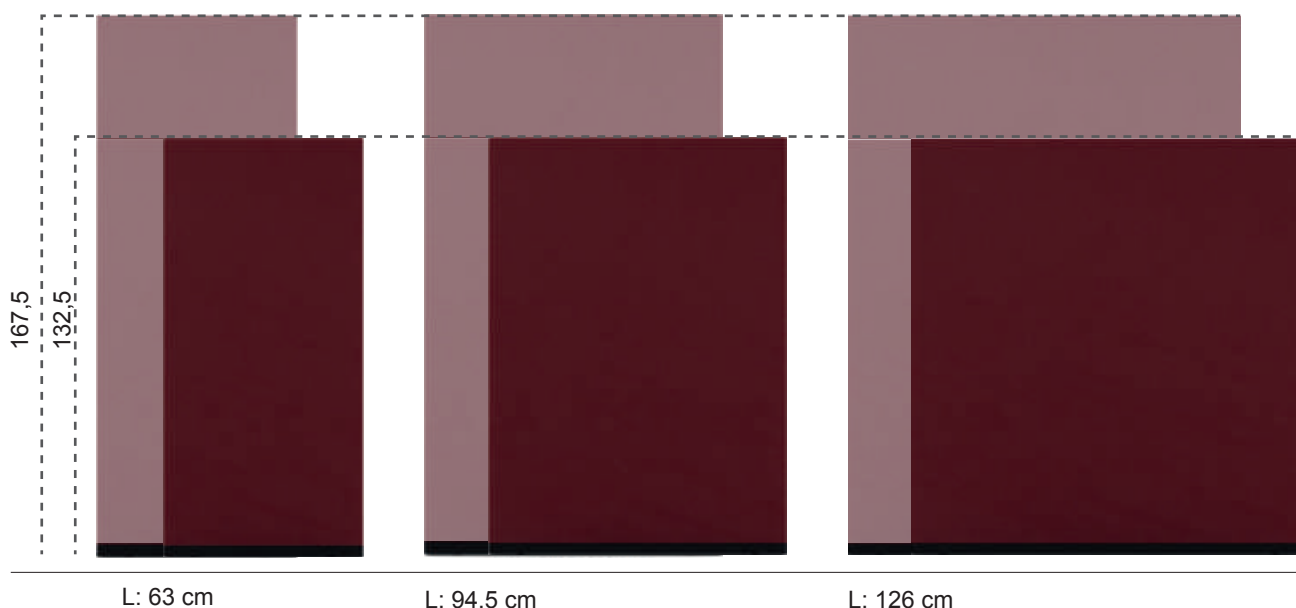

Rectangular panels with a curved profile

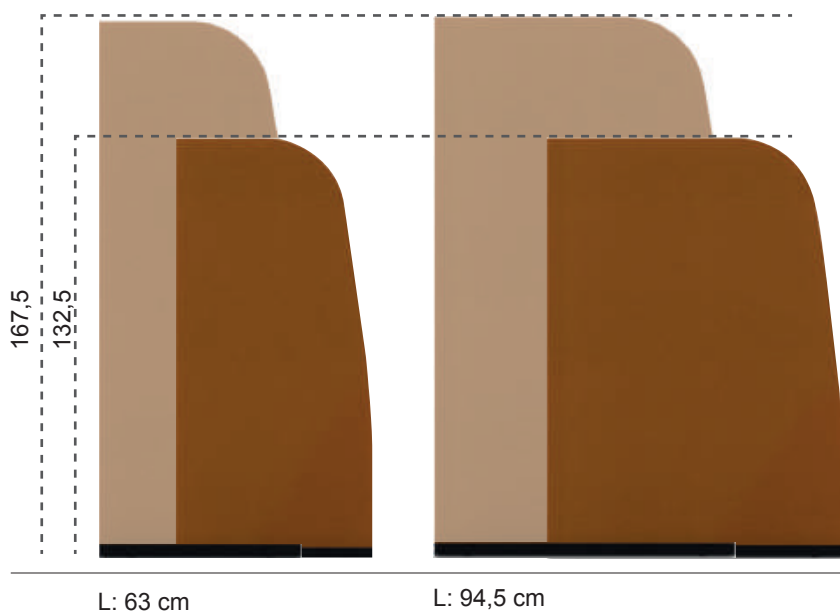

90° angular panels

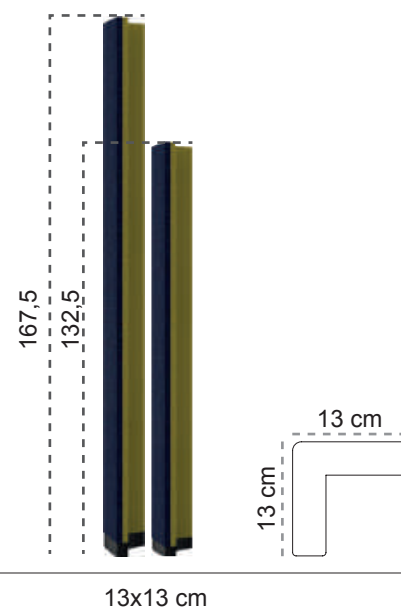

24% rabatt ska dras av på angivna priser

Paravan

Curved panel

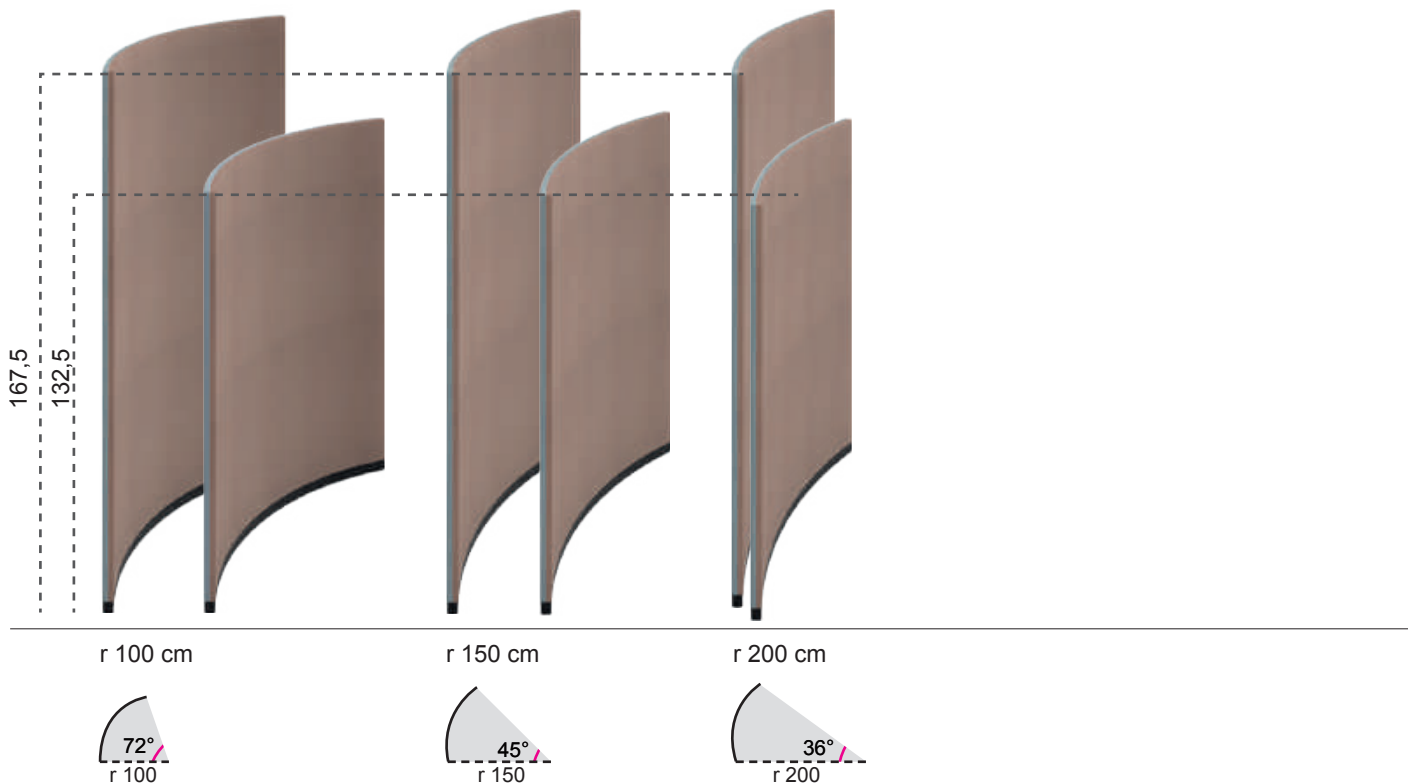

Cabinet — frame available in two heights — h 132,5 cm / 167,5 cm

The frame must be positioned between two panels of the same height and completed with accessories such as shelves and/or coat racks.

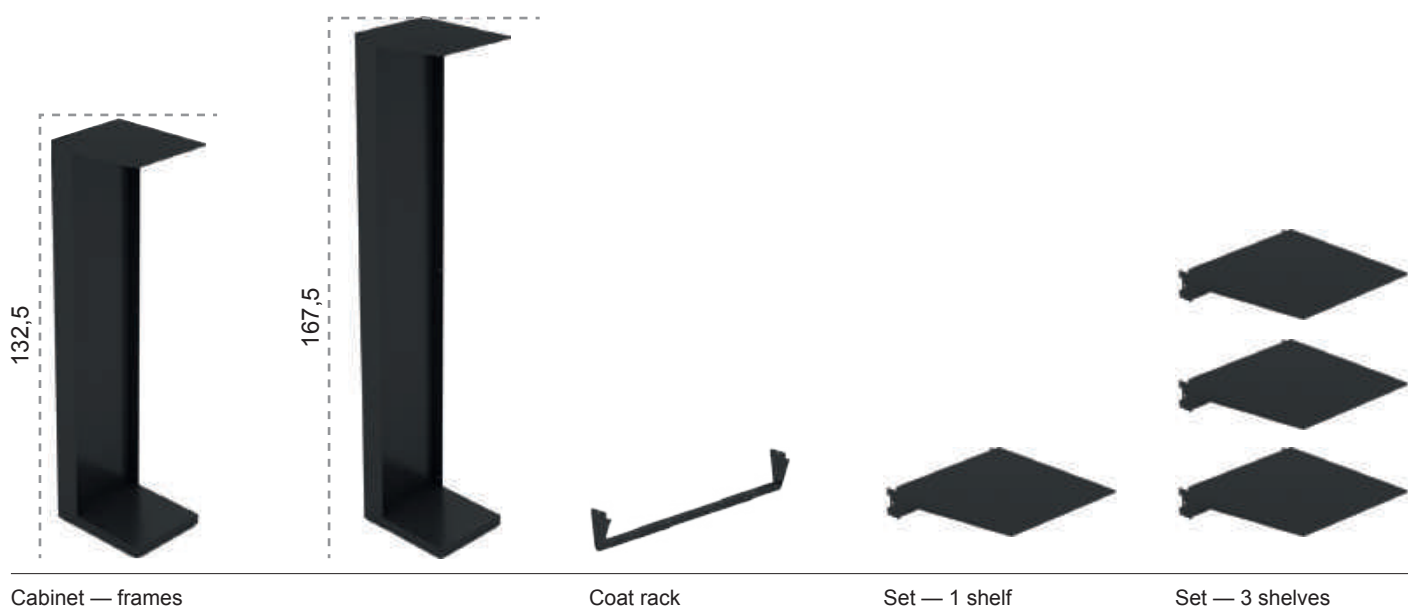

arper

24% rabatt ska dras av på angivna priser

Paravan

Desk panels



Desk panel
— L 98 cm



Desk panel
— L 159 cm



Desk panel
— L 179 cm

24% rabatt ska dras av på angivna priser

Paravan

Two-colour options for all panel versions

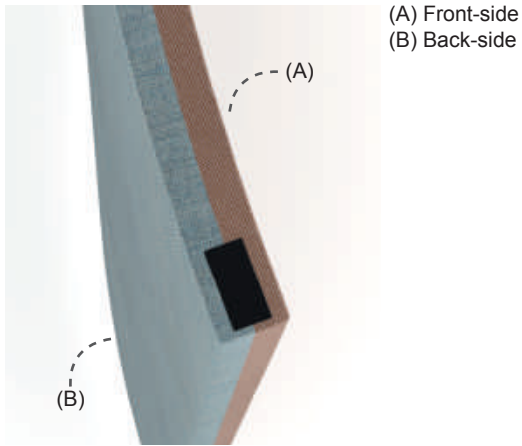

Two-colour arrangement detail

Rectangular panels

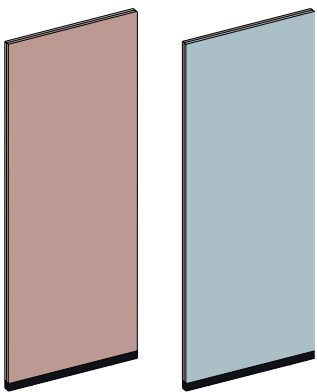

(A) Front-side (B) Back-side

Rectangular panels with a curved profile

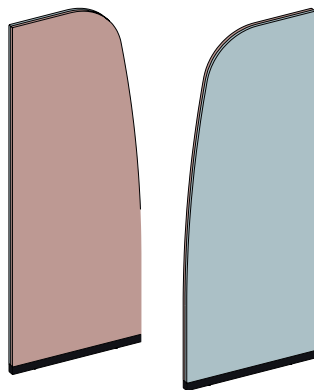

(A) Front-side (B) Back-side

90° angular panels

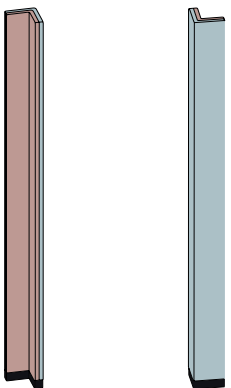

(A) Front-side (B) Back-side

Curved panel

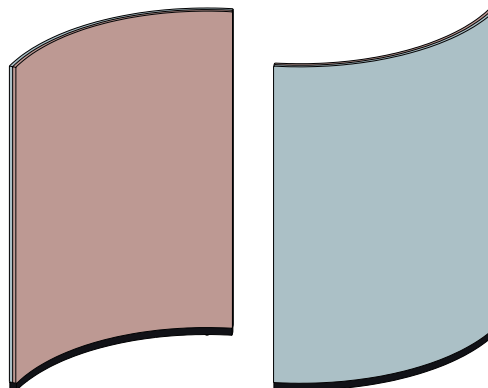

(A) Front-side (B) Back-side

24% rabatt ska dras av på angivna priser

Paravan

Connection systems

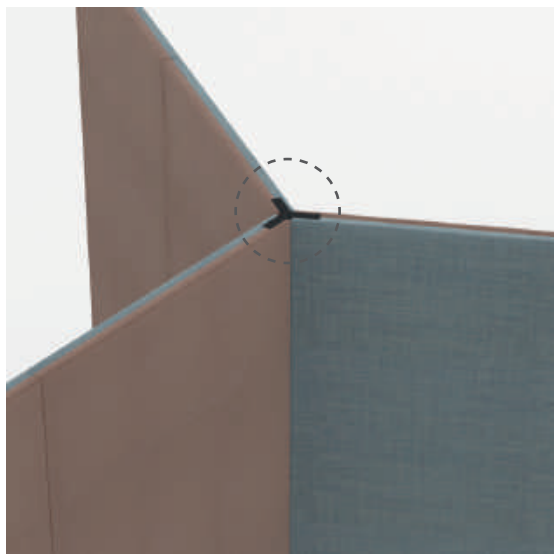

- Connection element with fastening kit for panels:
- 2-way linear link for 180° arrangements, Art. 6423
 - 2-way link for 90° arrangements, "L"-shaped Art. 6424
 - 2-way link for 135° arrangements, "V"-shaped Art. 6425
 - 3-way link for 90° arrangements, "T"-shaped Art. 6426
 - 3-way link for 120° arrangements, "Y"-shaped Art. 6427
 - 4-way link for 90° arrangements, "X"-shaped Art. 6428
 - Link for circular compositions Art. 6431

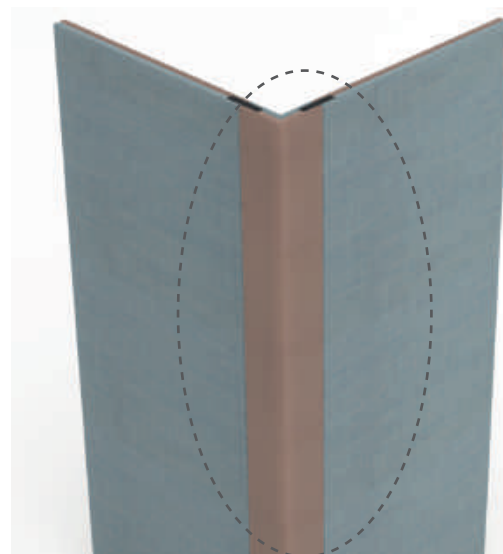

- "Connection element for 90° angular panels:
- 90° angular panels h 132,5 cm Art. 6416
 - 90° angular panels h 167,5 cm Art. 6417



- Connection system for Cabinet:
- Cabinet (frame) h 132,5 Art. 6418
 - Cabinet (frame) h 167,5 Art. 6419

**Tackable when configured
with proper textile**



24% rabatt ska dras av på angivna priser

Paravan Mood



Whiteboard

Magazine holder
— two types

Slim-line shell —
two types

Organizer

Mirror

Hook

Paravan Mood accessories are the only options for which Arper guarantees combination with Paravan's panels.



24% rabatt ska dras av på angivna priser

Paravan

Composition examples

Linear composition

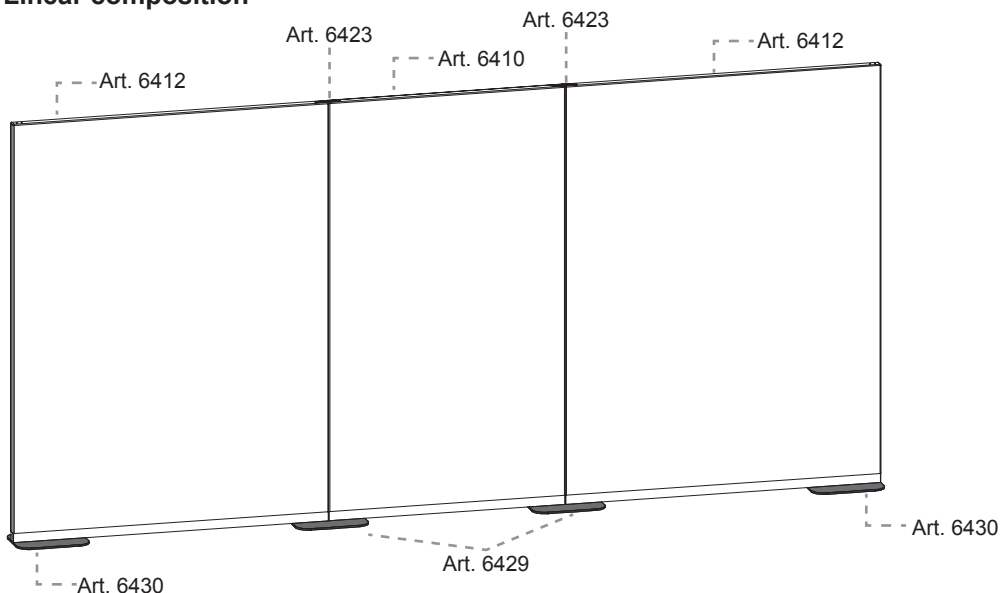

- 2 x Art. 6412 – Rectangular panel, h 167,5 cm width 126 cm
- 1 x Art. 6410 – Rectangular panel, h 167,5 cm width 94,5 cm
- 2 x Art. 6423 – 2-way linear link for 180° arrangements
- 2 x Art. 6430 – Single standard fixing plate
- 2 x Art. 6429 – Connection fixing plate

120° arrangement composition

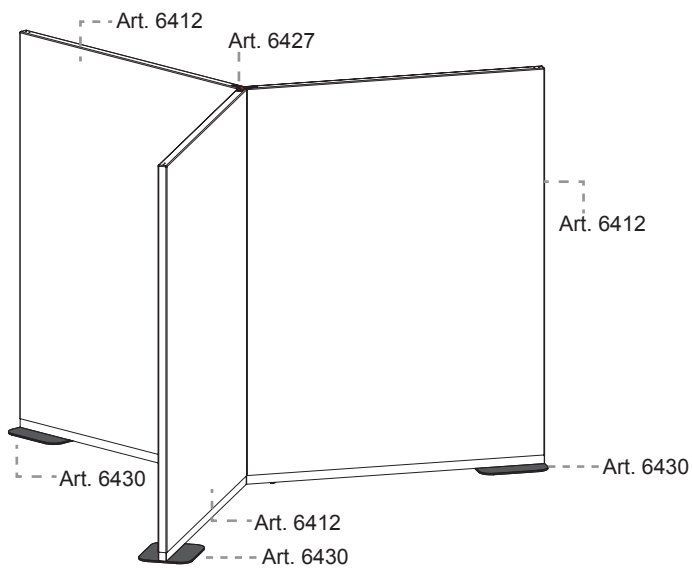

- 3 x Art. 6412 – Rectangular panel h 167,5 cm width 126 cm
- 1 x Art. 6427 – 3-way link for 120° arrangements, "Y"-shaped
- 3 x Art. 6430 – Single standard fixing plate

24% rabatt ska dras av på angivna priser

Paravan

135° arrangement composition

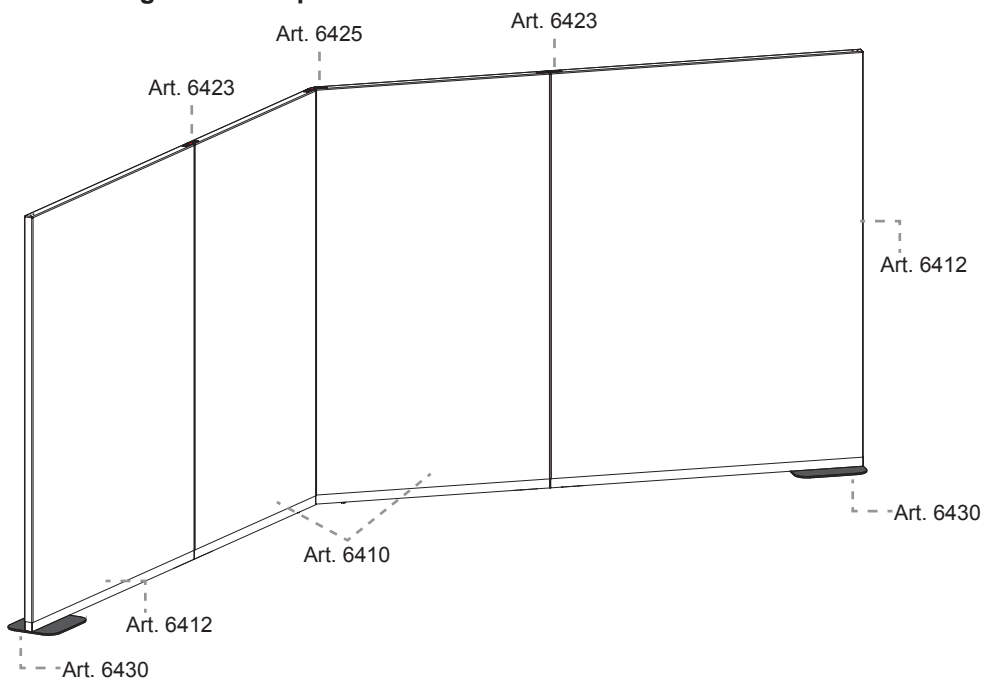

- 2 x Art. 6412 – Rectangular panel h 167,5 cm, width 126 cm
- 2 x Art. 6410 – Rectangular panel h 167,5 cm, width 94,5 cm
- 2 x Art. 6423 – 2-way linear link for 180° arrangements
- 1 x Art. 6425 – 2-way link for 135° arrangements, “V”-shaped
- 2 x Art. 6430 – Single standard fixing plate

4-way composition

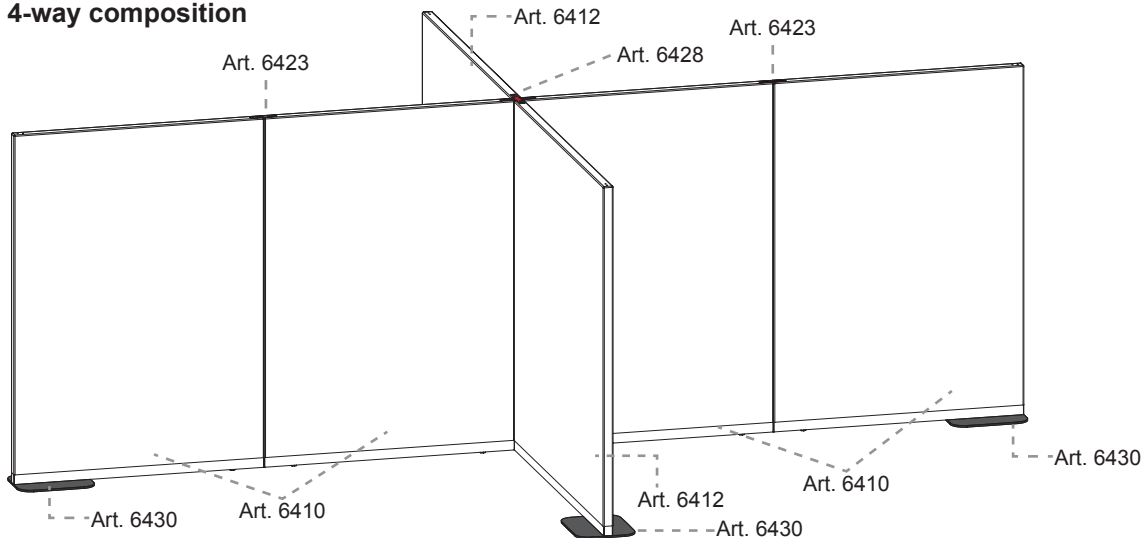

- 2 x Art. 6412 – Rectangular panel h 167,5 cm, width 126 cm
- 4 x Art. 6410 – Rectangular panel h 167,5 cm, width 126 cm
- 1 x Art. 6428 – 4-way link for 90° arrangements, X-shaped
- 4 x Art. 6430 – Single standard fixing plate
- 2 x Art. 6423 – 2-way linear link for 180° arrangements

24% rabatt ska dras av på angivna priser

Paravan

Circular composition

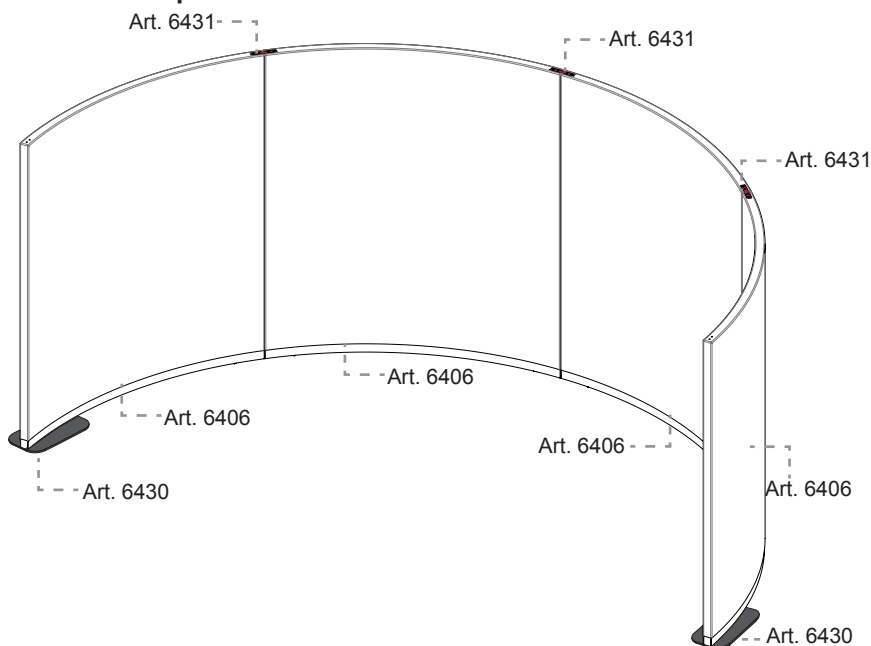

- 4 x Art. 6406 – Curved panel h 132,5 cm, radius 150 cm, width 114,5 cm
- 3 x Art. 6431 – Link for circular composition

Linear-circular composition

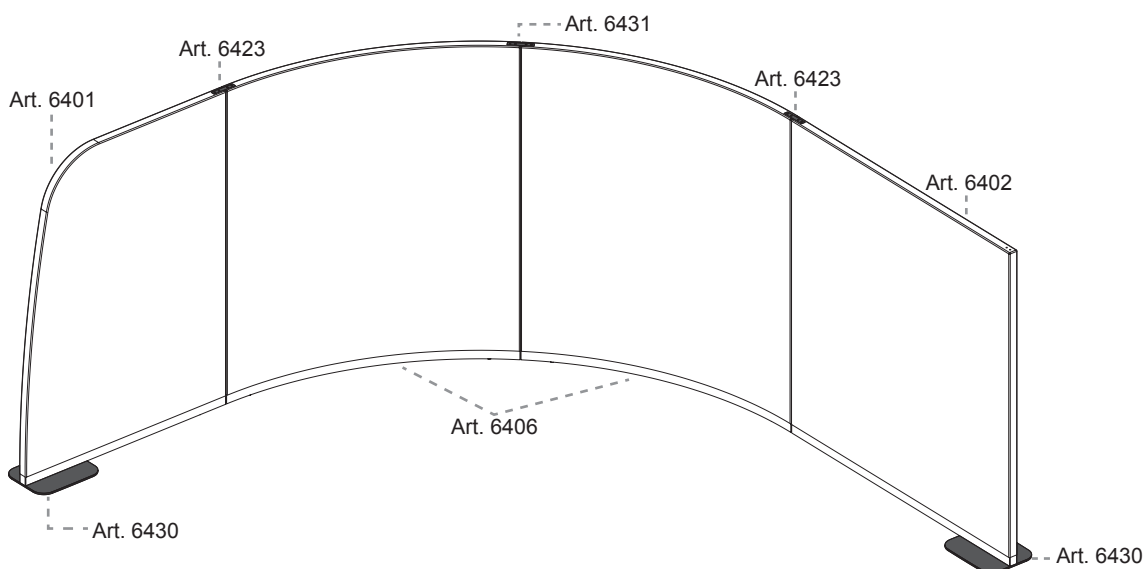

- 2 x Art. 6406 – Curved panel h 132,5 cm, radius 150 cm, width 114,5 cm
- 1 x Art. 6401 – Rectangular panel with 1 curved profile h 132,5 cm width 63 cm
- 1 x Art. 6402 – Rectangular panel h 132,5 cm width 94,5 cm
- 1 x Art. 6431 – Link for circular composition
- 2 x Art. 6430 – Single standard fixing plate
- 2 x Art. 6423 – 2-way linear link for 180° arrangements

24% rabatt ska dras av på angivna priser

Paravan

Double L-shape composition

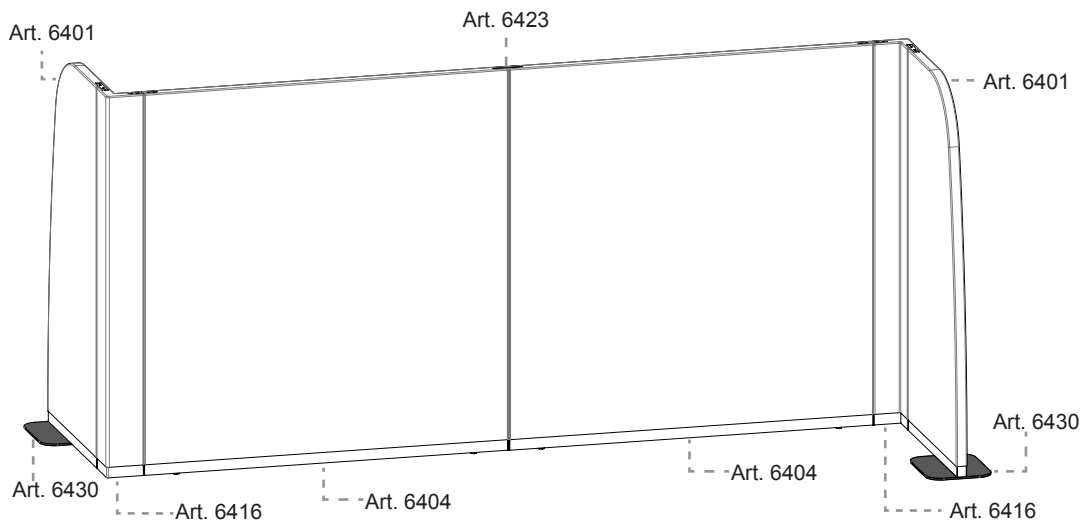

- 2 x Art. 6404 – Rectangular panel h 132,5 cm width 126 cm
- 2 x Art. 6401 – Rectangular panel with 1 curved profile h 132,5 cm width 63 cm
- 2 x Art. 6416 – 90° angular panel h 132,5 cm
- 1 x Art. 6423 – 2-way linear link for 180° arrangements
- 2 x Art. 6430 – Single standard fixing plate

Double U-shape composition

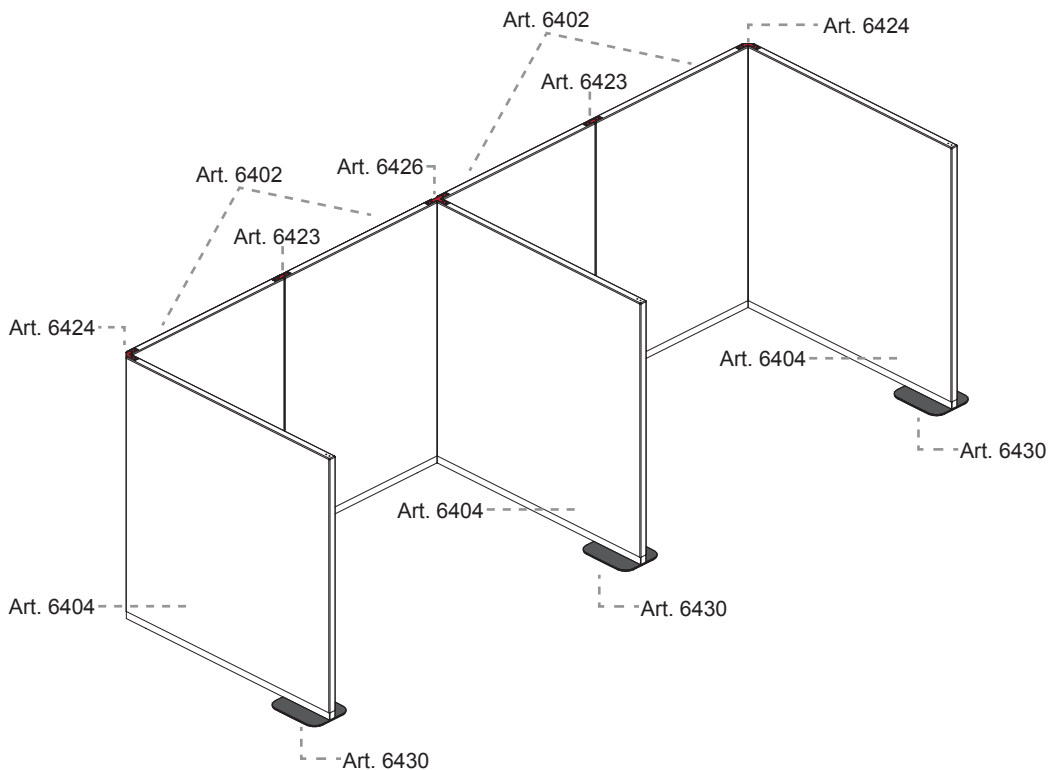

- 4 x Art. 6402 – Rectangular panel h 132,5 cm, width 94.5 cm
- 3 x Art. 6404 – Rectangular panel h 132,5 cm, width 126 cm
- 3 x Art. 6430 – Single standard fixing plate
- 2 x Art. 6423 – 2-way linear link for 180° arrangements
- 2 x Art. 6424 – 2-way link for 90° arrangements, L-shaped
- 1 x Art. 6426 – 3-way link for 90° arrangements, T-shaped

24% rabatt ska dras av på angivna priser

Paravan

Linear composition with Cabinet

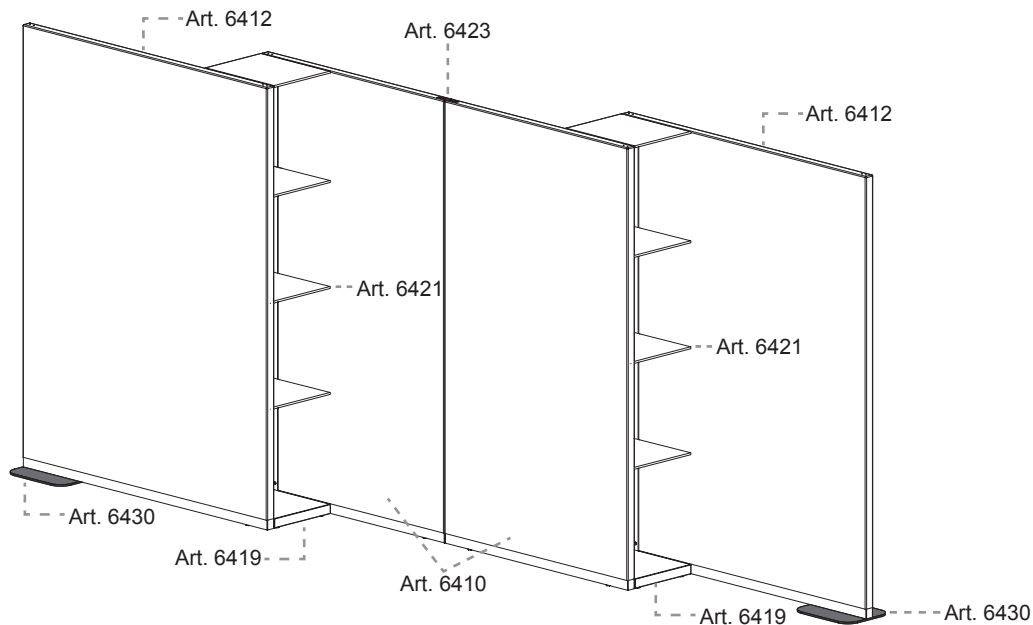

- 2 x Art. 6412 – Rectangular panel, h 167,5 cm width 126 cm
- 2 x Art. 6410 – Rectangular panel, h 167,5 cm width 94.5 cm
- 2 x Art. 6419 – Cabinet frame h 167,5 cm
- 2 x Art. 6421 – Kit 3 shelves
- 1 x Art. 6423 – 2-way linear link for 180° arrangements
- 2 x Art. 6430 – Single standard fixing plate

Composition examples

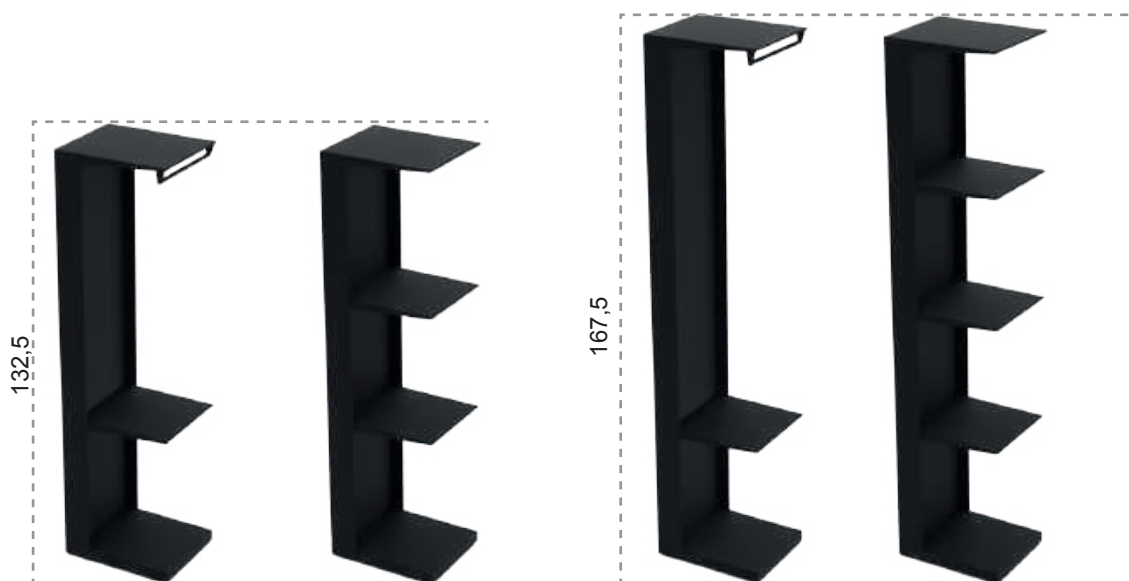

Cabinet h 132,5 cm with
— no.1 set of 3 shelves
— no. 1 Coat rack

Cabinet h 132,5 cm with
— no. 2 sets of 1 shelf

Cabinet 167,5 cm with
— no.1 set of 1 shelf
— coat rack

Cabinet 167,5 cm with
— no.1 set of 3 shelves

24% rabatt ska dras av på angivna priser

Paravan

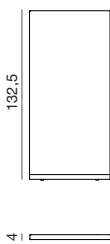

Design by Lievore Altherr, 2018

132.5 cm high rectangular panel available in three widths – 63, 94.5 and 126 cm – and upholstered in one colour fabric. The acoustic panel is available with a two colour upholstery upon request and with a surcharge. The base is in black aluminium. Fixing plate and linking elements are supplied separately for the creation of modular compositions.

Accessories:

2-way link Art. 6423

3-way link Art. 6427

Hook Art. 6438

Side XL-plates Art. 6449

Whiteboard Art. 6432

2-way link Art. 6424

4-way link Art. 6428

Magazine holder Art. 6433

Single standard fixing plate Art. 6430

2-way link Art. 6425

Cabinet H132,5 cm Art. 6418

Magazine holder Art. 6434

Slim-line shelf L 63 cm Art. 6435

3-way link Art. 6426

Connection fixing plate Art. 6429

Mirror Art. 6437

Slim-line shelf L 94.5 cm Art. 6436

SEK ART. 6400	A	B COM	C	D	E	F	G	H	I	J	K	L	M
L 63 cm	6880	7266	7652	8038	8424	8810	9196	9582	9968	10354	10740	11126	11512
SEK ART. 6402	A	B COM	C	D	E	F	G	H	I	J	K	L	M
L 94,5 cm	8412	9173	9934	10695	11456	12217	12978	13739	14500	15261	16022	16783	17544
SEK ART. 6404	A	B COM	C	D	E	F	G	H	I	J	K	L	M
L 126 cm	9625	10518	11411	12304	13197	14090	14983	15876	16769	17662	18555	19448	20341
Upholstered with a single material in two colors	+ 254		qty min. 2 pcs										

SHIPMENT DETAILS	TECHNICAL SPECIFICATIONS	RESISTANCE TEST
Art. 6400 1 pz = 1 - kg 13,65/ m² 0,068 Art. 6402 1 pz = 1 - kg 18,46/ m² 0,101 Art. 6404 1 pz = 1 - kg 23,4/ m² 0,133	Art.6400 H 140 cm. COM Meterage m 1.57 *Classe 1, 2, 1IM: fire retardant version available with surcharge and eventual minimum batch Art.6402 H 140 cm. COM Meterage m 3.01 *Classe 1, 2, 1IM: fire retardant version available with surcharge and eventual minimum batch Art.6404 H 140 cm. COM Meterage m 3.01 *Classe 1, 2, 1IM: fire retardant version available with surcharge and eventual minimum batch	
FIRE RETARDANT TEST • FIRE RETARDANT VERSION WITH SURCHARGE * Classe 1 Omologazione Italia Field Kvadrat.		

Frame Base



V39
matt

24% rabatt ska dras av på angivna priser

Paravan

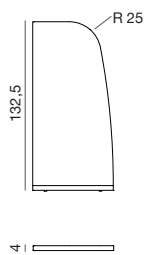

Design by Lievore Altherr, 2018

132.5 cm high rectangular panel with a curved profile, to be used to start or finish the composition, available in two widths – 63 and 94.5 cm – and upholstered in one colour fabric. The acoustic panel is available with a two colour upholstery upon request and with a surcharge. The base is in black aluminium. Fixing plate and linking elements are supplied separately for the creation of modular compositions.

Accessories:

2-way link Art. 6423
3-way link Art. 6427
Hook Art. 6438
Side XL-plates Art. 6449
Whiteboard Art. 6432

2-way link Art. 6424
4-way link Art. 6428
Magazine holder Art. 6433
Single standard fixing plate Art. 6430

2-way link Art. 6425
Cabinet H132,5 cm Art. 6418
Magazine holder Art. 6434
Slim-line shelf L 63 cm Art. 6435

3-way link Art. 6426
Connection fixing plate Art. 6429
Mirror Art. 6437
Slim-line shelf L 94.5 cm Art. 6436

SEK ART. 6401	A	B COM	C	D	E	F	G	H	I	J	K	L	M
L 63 cm	6880	7266	7652	8038	8424	8810	9196	9582	9968	10354	10740	11126	11512
SEK ART. 6403	A	B COM	C	D	E	F	G	H	I	J	K	L	M
L 94,5 cm	8412	9173	9934	10695	11456	12217	12978	13739	14500	15261	16022	16783	17544
Upholstered with a single material in two colors	+ 254 qty min. 2 pcs												

SHIPMENT DETAILS	TECHNICAL SPECIFICATIONS	RESISTANCE TEST
Art. 6401 1 pz = 1 - kg 13/ m² 0,068 Art. 6403 1 pz = 1 - kg 16,9/ m² 0,101	Art.6401 H 140 cm. COM Meterage m 1.57 *Classe 1, 2, 1IM: fire retardant version available with surcharge and eventual minimum batch Art.6403 H 140 cm. COM Meterage m 3.01 *Classe 1, 2, 1IM: fire retardant version available with surcharge and eventual minimum batch	
FIRE RETARDANT TEST • FIRE RETARDANT VERSION WITH SURCHARGE * Classe 1 Omologazione Italia Field Kvadrat.		

Frame Base



V39
matt

24% rabatt ska dras av på angivna priser

Paravan

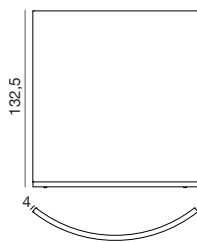

Design by Lievore Altherr, 2018

132.5 cm high curved panel available in three radius options – 100, 150 and 200 cm – and upholstered in one colour fabric. The acoustic panel is available with a two colour upholstery upon request and with a surcharge. The base is in black aluminium. Fixing plate and linking elements are supplied separately for the creation of modular compositions.

Accessories:

Connection fixing plate Art. 6429
Magazine holder Art. 6434

Hook Art. 6438
Mirror Art. 6437

Link for circular composition Art. 6431 Magazine holder Art. 6433
Single standard fixing plate Art. 6430

SEK ART. 6405	A	B COM	C	D	E	F	G	H	I	J	K	L	M
r 100 cm - 72 °	11080	11841	12602	13363	14124	14885	15646	16407	17168	17929	18690	19451	20212
SEK ART. 6406	A	B COM	C	D	E	F	G	H	I	J	K	L	M
r 150 cm - 45 °	11080	11841	12602	13363	14124	14885	15646	16407	17168	17929	18690	19451	20212
SEK ART. 6407	A	B COM	C	D	E	F	G	H	I	J	K	L	M
r 200 cm - 36 °	11080	11841	12602	13363	14124	14885	15646	16407	17168	17929	18690	19451	20212
Upholstered with a single material in two colors	+ 254		qty min. 2 pcs										

SHIPMENT DETAILS	TECHNICAL SPECIFICATIONS	RESISTANCE TEST
Art. 6405 1 pz = 1 - kg 24,7/ m² 0,621 Art. 6406 1 pz = 1 - kg 20,8/ m² 0,621 Art. 6407 1 pz = 1 - kg 18,2/ m² 0,621	Art.6405 H 140 cm. COM Meterage m 3.05 *Classe 1, 2, 1IM: fire retardant version available with surcharge and eventual minimum batch Art.6406 H 140 cm. COM Meterage m 3.05 *Classe 1, 2, 1IM: fire retardant version available with surcharge and eventual minimum batch Art.6407 H 140 cm. COM Meterage m 3.05 *Classe 1, 2, 1IM: fire retardant version available with surcharge and eventual minimum batch	
FIRE RETARDANT TEST • FIRE RETARDANT VERSION WITH SURCHARGE * Classe 1 Omologazione Italia Field Kvadrat.		

Frame Base



V39
matt

24% rabatt ska dras av på angivna priser

Paravan



Design by Lievore Altherr, 2018

90° angular panel, 132.5 cm high. Panel sides are 13 cm wide. Upholstered in one colour fabric. The panel is also available in two colour upholstery and with a surcharge. The base is in black aluminium.

SEK ART. 6416	A	B COM	C	D	E	F	G	H	I	J	K	L	M	
Upholstered with a single material in just one color	3440	3892	4344	4796	5248	5700	6152	6604	7056	7508	7960	8412	8864	
Upholstered with a single material in two colors	+ 254 qty min. 2 pcs													

SHIPMENT DETAILS	TECHNICAL SPECIFICATIONS	RESISTANCE TEST
Art. 6416 1 pz = 1  - kg 6,5/ m² 0,033	Art.6416 H 140 cm. COM Meterage m 1.53 *Classe 1, 2, 1IM: fire retardant version available with surcharge and eventual minimum batch	
FIRE RETARDANT TEST • FIRE RETARDANT VERSION WITH SURCHARGE * Classe 1 Omologazione Italia Field Kvadrat.		

Frame Base



V39
matt

24% rabatt ska dras av på angivna priser

Paravan

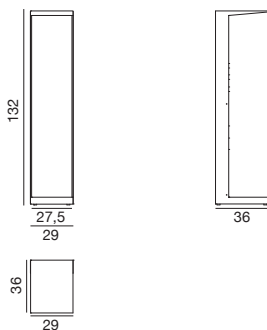

Design by Lievore Altherr, 2018

132 cm high metal storage unit, to be positioned between two panels of the same height and to be completed with accessories such as shelves and coat racks.

Accessories:

Coat rack Art. 6422

Set - 1 shelf Art. 6420

Set - 3 shelves Art. 6421

SEK ART. 6418	-	
Cabinet — frame h 132,5	6758	

SHIPMENT DETAILS	TECHNICAL SPECIFICATIONS	RESISTANCE TEST
Art. 6418 1 pz = 1  - kg 29,07/ m³ 0,201		
FIRE RETARDANT TEST		

Frame Base



V39
matt

24% rabatt ska dras av på angivna priser

Paravan

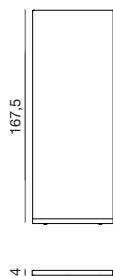

Design by Lievore Altherr, 2018

167.5 cm high rectangular panel available in three widths – 63, 94.5 and 126 cm – and upholstered in one colour fabric. The acoustic panel is available with a two colour upholstery upon request and with a surcharge. The base is in black aluminium. Fixing plate and linking elements are supplied separately for the creation of modular compositions.

Accessories:

2-way link Art. 6423

3-way link Art. 6427

Hook Art. 6438

Side XL-plates Art. 6449

Whiteboard Art. 6432

2-way link Art. 6424

4-way link Art. 6428

Magazine holder Art. 6433

Single standard fixing plate Art. 6430

2-way link Art. 6425

Cabinet H167,5 cm Art. 6419

Magazine holder Art. 6434

Slim-line shelf L 63 cm Art. 6435

3-way link Art. 6426

Connection fixing plate Art. 6429

Mirror Art. 6437

Slim-line shelf L 94.5 cm Art. 6436

SEK ART. 6408	A	B COM	C	D	E	F	G	H	I	J	K	L	M
L 63 cm	8147	8533	8919	9305	9691	10077	10463	10849	11235	11621	12007	12393	12779
SEK ART. 6410	A	B COM	C	D	E	F	G	H	I	J	K	L	M
L 94,5 cm	9934	10695	11456	12217	12978	13739	14500	15261	16022	16783	17544	18305	19066
SEK ART. 6412	A	B COM	C	D	E	F	G	H	I	J	K	L	M
L 126 cm	11080	11973	12866	13759	14652	15545	16438	17331	18224	19117	20010	20903	21796
Upholstered with a single material in two colors	+ 386		qty min. 2 pcs										

SHIPMENT DETAILS	TECHNICAL SPECIFICATIONS	RESISTANCE TEST
Art. 6408 1 pz = 1 - kg 16,25/ m² 0,086 Art. 6410 1 pz = 1 - kg 22,1/ m² 0,126 Art. 6412 1 pz = 1 - kg 27,3/ m² 0,167	Art.6408 H 140 cm. COM Meterage m 1.93 *Classe 1, 2, 1IM: fire retardant version available with surcharge and eventual minimum batch Art.6410 H 140 cm. COM Meterage m 3.81 *Classe 1, 2, 1IM: fire retardant version available with surcharge and eventual minimum batch Art.6412 H 140 cm. COM Meterage m 3.81 *Classe 1, 2, 1IM: fire retardant version available with surcharge and eventual minimum batch	
FIRE RETARDANT TEST • FIRE RETARDANT VERSION WITH SURCHARGE * Classe 1 Omologazione Italia Field Kvadrat.		

Frame Base



V39
matt

24% rabatt ska dras av på angivna priser

Paravan

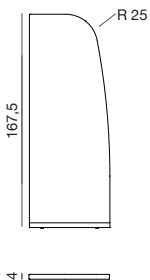

Design by Lievore Altherr, 2018

167.5 cm high rectangular panel with a curved profile, to be used to start or finish the composition, available in two widths – 63 and 94.5 cm – and upholstered in one colour fabric. The acoustic panel is available with a two colour upholstery upon request and with a surcharge. The base is in black aluminium. Fixing plate and connection elements are supplied separately for the creation of modular compositions.

Accessories:

2-way link Art. 6423

3-way link Art. 6427

Hook Art. 6438

Side XL-plates Art. 6449

Whiteboard Art. 6432

2-way link Art. 6424

4-way link Art. 6428

Magazine holder Art. 6433

Single standard fixing plate Art. 6430

2-way link Art. 6425

Cabinet H167,5 cm Art. 6419

Magazine holder Art. 6434

Slim-line shelf L 63 cm Art. 6435

3-way link Art. 6426

Connection fixing plate Art. 6429

Mirror Art. 6437

Slim-line shelf L 94.5 cm Art. 6436

SEK ART. 6409	A	B COM	C	D	E	F	G	H	I	J	K	L	M
L 63 cm	8147	8533	8919	9305	9691	10077	10463	10849	11235	11621	12007	12393	12779
SEK ART. 6411	A	B COM	C	D	E	F	G	H	I	J	K	L	M
L 94,5 cm	9934	10695	11456	12217	12978	13739	14500	15261	16022	16783	17544	18305	19066
Upholstered with a single material in two colors	+ 386 qty min. 2 pcs												

SHIPMENT DETAILS	TECHNICAL SPECIFICATIONS	RESISTANCE TEST
Art. 6409 1 pz = 1 - kg 15,6/ m² 0,086 Art. 6411 1 pz = 1 - kg 20,8/ m² 0,126	Art.6409 H 140 cm. COM Meterage m 1.93 *Classe 1, 2, 1IM: fire retardant version available with surcharge and eventual minimum batch Art.6411 H 140 cm. COM Meterage m 3.81 *Classe 1, 2, 1IM: fire retardant version available with surcharge and eventual minimum batch	
FIRE RETARDANT TEST • FIRE RETARDANT VERSION WITH SURCHARGE * Classe 1 Omologazione Italia Field Kvadrat.		

Frame Base



V39
matt

24% rabatt ska dras av på angivna priser

Paravan

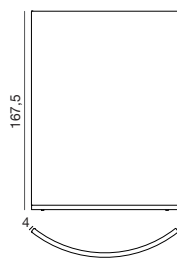

Design by Lievore Altherr, 2018

167.5 cm high curved rectangular panel available in three radius options – 100, 150 and 200 cm – and upholstered in one colour fabric. The acoustic panel is available with a two colour upholstery upon request and with a surcharge. The base is in black aluminium. Fixing plate and linking elements are supplied separately for the creation of modular compositions.

Accessories:

Connection fixing plate Art. 6429
Magazine holder Art. 6434

Hook Art. 6438
Mirror Art. 6437

Link for circular composition Art. 6431 Magazine holder Art. 6433
Single standard fixing plate Art. 6430

SEK ART. 6413	A	B COM	C	D	E	F	G	H	I	J	K	L	M
r 100 cm - 72 °	12480	13494	14508	15522	16536	17550	18564	19578	20592	21606	22620	23634	24648
SEK ART. 6414	A	B COM	C	D	E	F	G	H	I	J	K	L	M
r 150 cm - 45°	12480	13494	14508	15522	16536	17550	18564	19578	20592	21606	22620	23634	24648
SEK ART. 6415	A	B COM	C	D	E	F	G	H	I	J	K	L	M
r 200 cm - 36°	12480	13494	14508	15522	16536	17550	18564	19578	20592	21606	22620	23634	24648
Upholstered with a single material in two colors	+ 386		qty min. 2 pcs										

SHIPMENT DETAILS	TECHNICAL SPECIFICATIONS	RESISTANCE TEST
Art. 6413 1 pz = 1 - kg 29,9/ m² 0,769 Art. 6414 1 pz = 1 - kg 27,3/ m² 0,769 Art. 6415 1 pz = 1 - kg 23,4/ m² 0,769	Art.6413 H 140 cm. COM Meterage m 3.81 *Classe 1, 2, 1IM: fire retardant version available with surcharge and eventual minimum batch Art.6414 H 140 cm. COM Meterage m 3.81 *Classe 1, 2, 1IM: fire retardant version available with surcharge and eventual minimum batch Art.6415 H 140 cm. COM Meterage m 3.81 *Classe 1, 2, 1IM: fire retardant version available with surcharge and eventual minimum batch	
FIRE RETARDANT TEST • FIRE RETARDANT VERSION WITH SURCHARGE * Classe 1 Omologazione Italia Field Kvadrat.		

Frame Base



V39
matt

24% rabatt ska dras av på angivna priser

Paravan

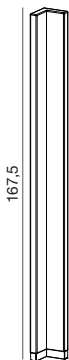

Design by Lievore Altherr, 2018

90° angular panel, 167.5 cm high. Panel sides are 13 cm wide. Upholstered in one colour fabric. The panel is also available in a two colour version with a surcharge. The base is in black aluminium.

SEK ART. 6417	A	B COM	C	D	E	F	G	H	I	J	K	L	M
Upholstered with a single material in just one color	3958	4410	4862	5314	5766	6218	6670	7122	7574	8026	8478	8930	9382
Upholstered with a single material in two colors	+ 386 qty min. 2 pcs												

SHIPMENT DETAILS	TECHNICAL SPECIFICATIONS	RESISTANCE TEST
Art. 6417 1 pz = 1  - kg 10,4/ m² 0,041	Art.6417 H 140 cm. COM Meterage m 1.93 *Classe 1, 2, 1IM: fire retardant version available with surcharge and eventual minimum batch	
FIRE RETARDANT TEST		
• FIRE RETARDANT VERSION WITH SURCHARGE * Classe 1 Omologazione Italia Field Kvadrat.		

Frame Base



V39
matt

24% rabatt ska dras av på angivna priser

Paravan

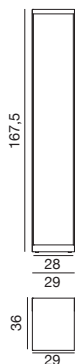

Design by Lievore Altherr, 2018

167.5 cm high metal storage unit to be positioned between two panels of the same height and to be completed with accessories such as shelves and coat racks.

Accessories:
Coat rack Art. 6422

Set - 1 shelf Art. 6420

Set - 3 shelves Art. 6421

SEK ART. 6419	-	
Cabinet — frame h 167,5	7773	

SHIPMENT DETAILS	TECHNICAL SPECIFICATIONS	RESISTANCE TEST
Art. 6419 1 pz = 1  - kg 36,4/ m ³ 0,253		
FIRE RETARDANT TEST		

Frame Base





V39
matt





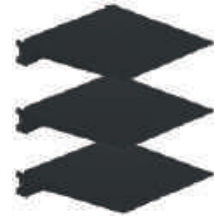

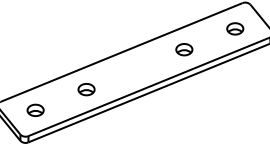
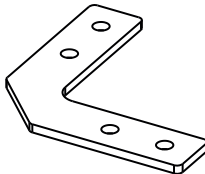
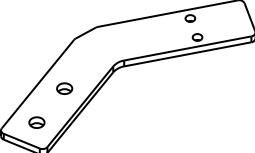
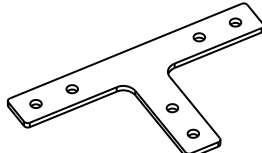
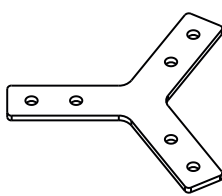
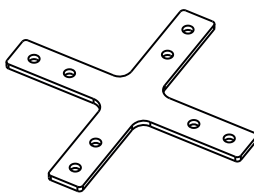
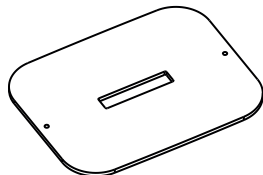
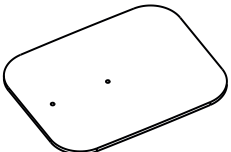
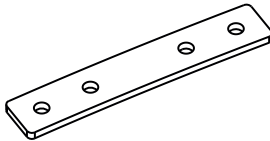
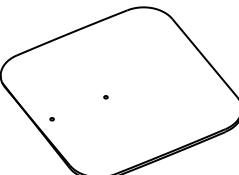
24% rabatt ska dras av på angivna priser







Accessories

Design by Lievore Altherr, 2018

<p>SEK ART. 6420</p>  <p>Set - 1 shelf</p> <p>1058</p>	<p>SEK ART. 6421</p>  <p>Set - 3 shelves</p> <p>2426</p>	<p>SEK ART. 6422</p>  <p>28,5 cm (11 1/4")</p> <p>Coat rack</p> <p>650</p>	<p>SEK ART. 6423</p>  <p>2-way linear link for 180° arrangements</p> <p>232</p>	<p>SEK ART. 6424</p>  <p>2-way link for 90° arrangements, "L"-shaped</p> <p>232</p>
<p>SEK ART. 6425</p>  <p>2-way link for 135° arrangements, "V"-shaped</p> <p>232</p>	<p>SEK ART. 6426</p>  <p>3-way link for 90° arrangements, "T"-shaped</p> <p>265</p>	<p>SEK ART. 6427</p>  <p>3-way link for 120° arrangements, "Y"-shaped</p> <p>265</p>	<p>SEK ART. 6428</p>  <p>4-way link for 90° arrangements, "X"-shaped</p> <p>309</p>	<p>SEK ART. 6429</p>  <p>Connection fixing plate</p> <p>606</p>
<p>SEK ART. 6430</p>  <p>Single standard fixing plate 29x22,5 cm</p> <p>606</p>	<p>SEK ART. 6431</p>  <p>Link for circular compositions</p> <p>232</p>	<p>SEK ART. 6449</p>  <p>Set of side fixing XL-plates 29x34,5 cm</p> <p>1224</p>		

SHIPMENT DETAILS

Art. 6420 1 pz = 1  - kg 2,6/ m³ 0,015
 Art. 6422 1 pz = 1  - kg 0,5/ m³ 0,001
 Art. 6424 1 pz = 1  - kg 0,5/ m³ 0,004
 Art. 6426 1 pz = 1  - kg 0,5/ m³ 0,004
 Art. 6428 1 pz = 1  - kg 0,5/ m³ 0,004
 Art. 6430 1 pz = 1  - kg 3,9/ m³ 0,004

Art. 6421 1 pz = 1  - kg 7,8/ m³ 0,031
 Art. 6423 1 pz = 1  - kg 0,5/ m³ 0,004
 Art. 6425 1 pz = 1  - kg 0,5/ m³ 0,004
 Art. 6427 1 pz = 1  - kg 0,5/ m³ 0,004
 Art. 6429 1 pz = 1  - kg 3,9/ m³ 0,004
 Art. 6431 1 pz = 1  - kg 0,5/ m³ 0,004

TECHNICAL SPECIFICATIONS

FIRE RETARDANT TEST

24% rabatt ska dras av på angivna priser

Paravan Desk Panel

Design by Lievore Altherr, 2019

Desk panel available in three widths (98, 159 and 179 cm) and upholstered in fabric. The panel is also available at an additional cost with a two-tone Upholstery. The base is made of powder-coated sheet steel.

Accessories:
Organizer Art. 6442

ART. 6439

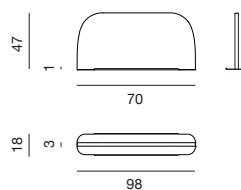

ART. 6440

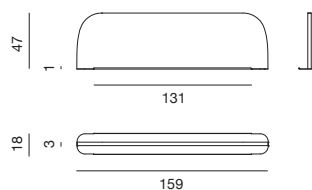
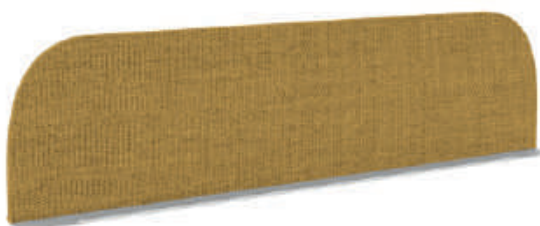

ART. 6441

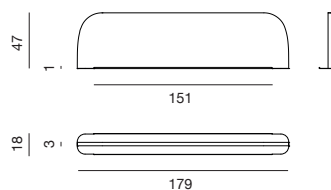

SHIPMENT DETAILS	TECHNICAL SPECIFICATIONS	RESISTANCE TEST
<p>Art. 6439 1 pz = 1 - kg 9/ m³ 0,04</p> <p>Art. 6440 1 pz = 1 - kg 14/ m³ 0,064</p> <p>Art. 6441 1 pz = 1 - kg 17/ m³ 0,071</p>	<p>Art.6439 H 140 cm. COM Meterage m 1.18 *Classe 1, 2, 11M: fire retardant version available with surcharge and eventual minimum batch</p> <p>Art.6440 H 140 cm. COM Meterage m 1.85 *Classe 1, 2, 11M: fire retardant version available with surcharge and eventual minimum batch</p> <p>Art.6441 H 140 cm. COM Meterage m 2.07 *Classe 1, 2, 11M: fire retardant version available with surcharge and eventual minimum batch</p>	

24% rabatt ska dras av på angivna priser

Paravan Desk Panel

Design by Lievore Altherr, 2019

SEK ART. 6439	A	B COM	C COL	D	E	F	G	H	I	J	K	L	M
Desk Panel L cm 98	2833	3175	3517	3859	4201	4543	4885	5227	5569	5911	6253	6595	6937
Upholstered with a single material in two colors	+ 254 qty min. 2 pcs												
SEK ART. 6440	A	B COM	C COL	D	E	F	G	H	I	J	K	L	M
Desk Panel L cm 159	4013	4542	5071	5600	6129	6658	7187	7716	8245	8774	9303	9832	10361
Upholstered with a single material in two colors	+ 254 qty min. 2 pcs												
SEK ART. 6441	A	B COM	C COL	D	E	F	G	H	I	J	K	L	M
Desk Panel L cm 179	4531	5126	5721	6316	6911	7506	8101	8696	9291	9886	10481	11076	11671
Upholstered with a single material in two colors	+ 254 qty min. 2 pcs												
FIRE RETARDANT TEST													
• FIRE RETARDANT VERSION WITH SURCHARGE * Classe 1 Omologazione Italia Field Kvadrat.													

Frame Base



V24
matt

V44
matt

24% rabatt ska dras av på angivna priser

Paravan Mood

Design by Lievore Altherr, 2019

Whiteboard in steel sheet powder-coated with writable paint (Item 6432) and including kit for fixing to the Paravan panels. The board can be completed with the magnetic pen holder (Item 6448). The board can also be fixed to the wall using the specific optional kit.

Accessories:
Pen holder Art. 6448

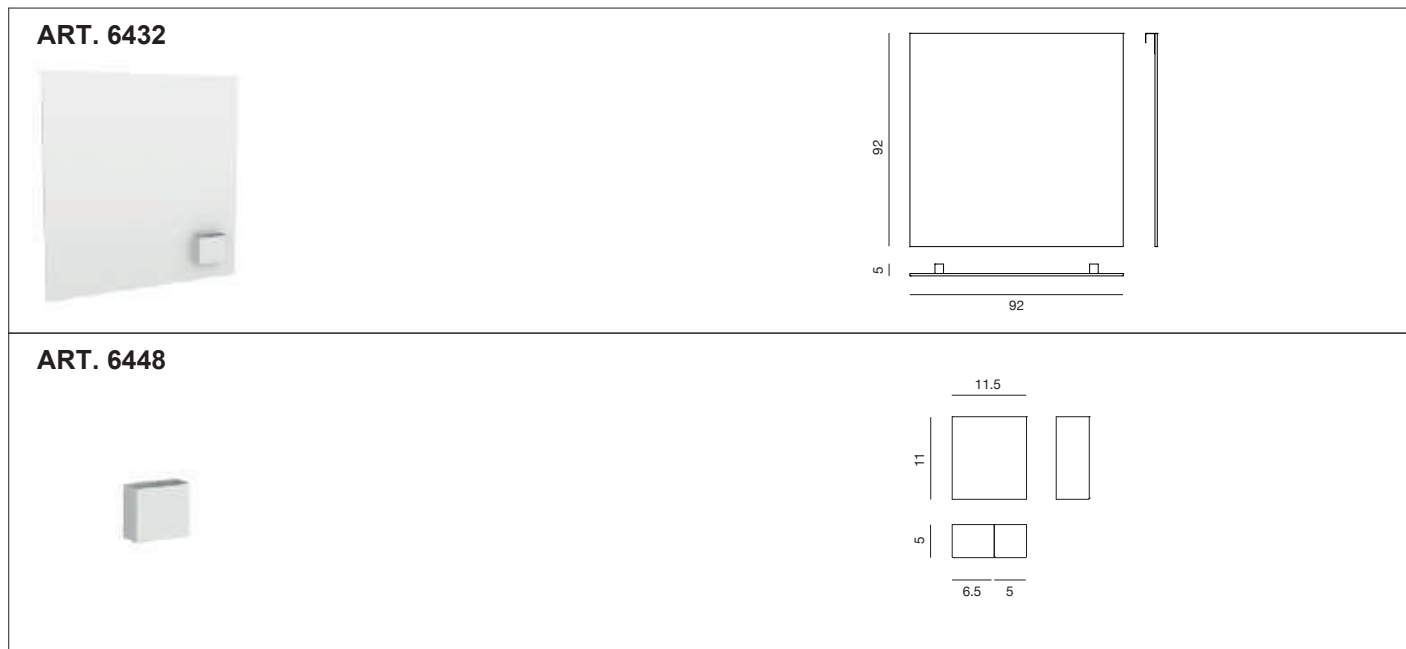

SEK ART. 6432	-	
Whiteboard	1929	
SEK ART. 6448	-	
Pen holder	805	

SHIPMENT DETAILS	TECHNICAL SPECIFICATIONS	RESISTANCE TEST
Art. 6432 1 pz = 1 - kg 9,5/ m² 0,07 Art. 6448 1 pz = 1 - kg 1,5/ m² 0,002		

Frame Base



24% rabatt ska dras av på angivna priser

Paravan Mood

Design by Lievore Altherr, 2019

Magazine holder in powder-coated steel sheet available in two versions and including kit for fixing to the Paravan panels. Magazine racks can also be fixed to the wall using the specific optional kit.

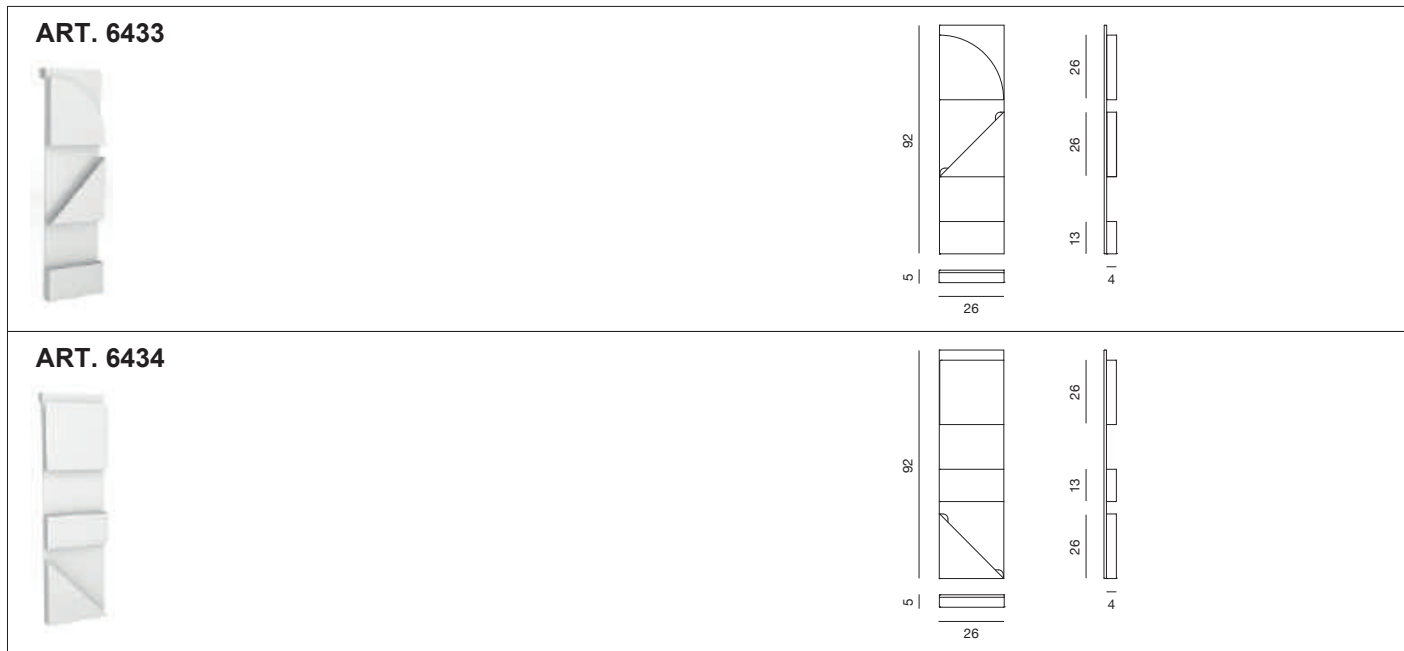

SEK ART. 6433	-	
Magazine holder	2304	
SEK ART. 6434	-	
Magazine holder	2304	

SHIPMENT DETAILS	TECHNICAL SPECIFICATIONS	RESISTANCE TEST
Art. 6433 1 pz = 1 - kg 4,5/ m² 0,019 Art. 6434 1 pz = 1 - kg 4,5/ m² 0,044		

Frame Base



24% rabatt ska dras av på angivna priser

Paravan Mood

Design by Lievore Altherr, 2019

Shelf in powder-coated sheet steel available in two widths, 63 cm (Item 6435) and 94.5 cm (Item 6436) and including kit for fixing to the Paravan panels. The shelves can also be fixed to the wall using the specific optional kit.

ART. 6435

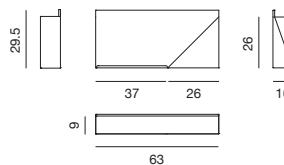

ART. 6436

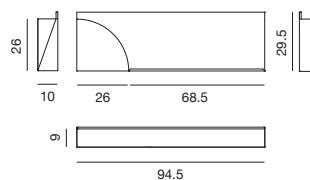

SEK ART. 6435	-	
Slim-line shelf L cm 63	1158	
SEK ART. 6436	-	
Slim-line shelf L cm 94,5	1411	

SHIPMENT DETAILS	TECHNICAL SPECIFICATIONS	RESISTANCE TEST
Art. 6435 1 pz = 1 - kg 4/ m ² 0,029 Art. 6436 1 pz = 1 - kg 6/ m ² 0,043		

Frame Base



24% rabatt ska dras av på angivna priser





Paravan Mood

Design by Lievore Altherr, 2019

Mirror (Item 6437) and Pair of hooks (Item 6438) in powder-coated steel sheet to be fixed to the Paravan panels.



SEK ART. 6437	-	
Mirror	992	
SEK ART. 6438	-	
Hook (2 pieces)	474	

SHIPMENT DETAILS	TECHNICAL SPECIFICATIONS	RESISTANCE TEST
<p>Art. 6437 1 pz = 1  - kg 2/ m³ 0,007</p> <p>Art. 6438 1 pz = 1  - kg 1,5/ m³ 0,004 2 pz = 1  - kg 2/ m³ 0,004 5 pz = 1  - kg 3/ m³ 0,004</p>		

Frame Base



24% rabatt ska dras av på angivna priser

Paravan Mood

Design by Lievore Altherr, 2019

Organizer in powder-coated sheet steel. It can be placed on the base of the desk panels or directly on tables and desks.

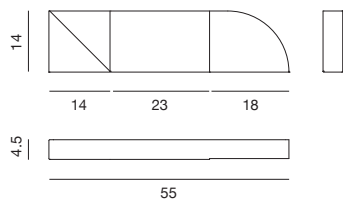

SEK ART. 6442	-	
Organizer	1125	

SHIPMENT DETAILS	TECHNICAL SPECIFICATIONS	RESISTANCE TEST
Art.6442 1 pz = 1  - kg 2,5/ m² 0,005		
FIRE RETARDANT TEST		

Frame Base



24% rabatt ska dras av på angivna priser

Accessories



Design by Lievore Altherr

SEK ART. 6443



Wall-mount kit

353

SHIPMENT DETAILS	TECHNICAL SPECIFICATIONS	RESISTANCE TEST
Art. 6443 1 pz = 1  - kg 1,5/ m ² 0,004 2 pz = 1  - kg 1,5/ m ² 0,004		
FIRE RETARDANT TEST		

24% rabatt ska dras av på angivna priser

24% rabatt ska dras av på angivna priser

PARENTESIT

Design by
Lievore Altherr Molina
2015

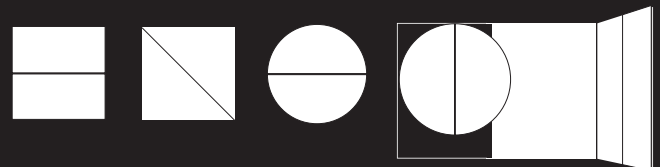

24% rabatt ska dras av på angivna priser

Parentesit

Collection overview

Wall Panel



Square version
one colour or two colours
version, with horizontal insert



Square version
one color or two colors version,
with diagonal insert



Round version
one color or two colors version,
with central insert

Freestanding

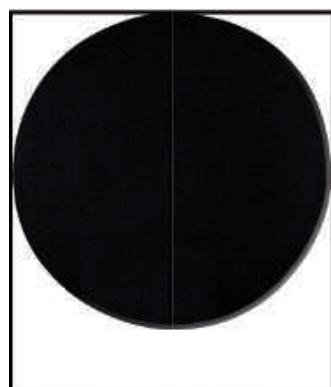

Freestanding module made up of
a round panel upholstered in one
color fabric on a matt black metal
base.

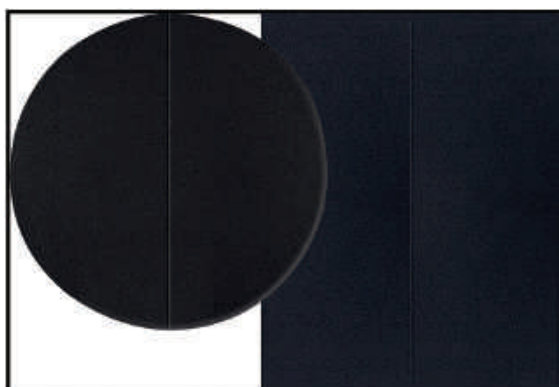

Freestanding module made up of a round and a square
panel upholstered in one color fabric, with the choice of
a different color for one panel, and resting on a matt black
metal base.

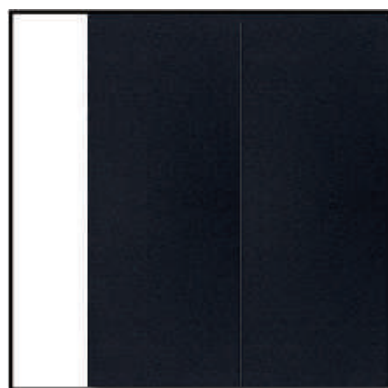

Freestanding module made up of a square panel
upholstered in one color fabric on a matt black base.

24% rabatt ska dras av på angivna priser

Parentesit Wall Panel

The primary forms of Parentesit can be arranged to articulate graphic patterns adaptable to any environment.

The positions of the panels can further be assembled into different orientation options that extend the geometric visual language into compositions of parallel, perpendicular, or diagonal lines. All orientations of Parentesit can be determined in the installation process and, with only few tools required, can mount onto any wall surface. Minimal in form, minimal in effort.

The central aesthetic profile is available in the following colours:

- V12 (White Matt)
- V39 (Black Matt)

Warranty: 2 years

The Parentesit Wall Panel is available with three options for embedded functionality.

- 1 Sound Absorbing:
an acoustic panel version is made from certified sound absorbing materials for when quiet space is needed.
- 2 Light:
a switch-operated, built-in light-enabled version enhances visual impact.
- 3 Audio + Light:
light-and-audio-enabled version with dimmer switch is manageable via dedicated app.dedicata (downloadable from App Store and Google Play).

Composition examples

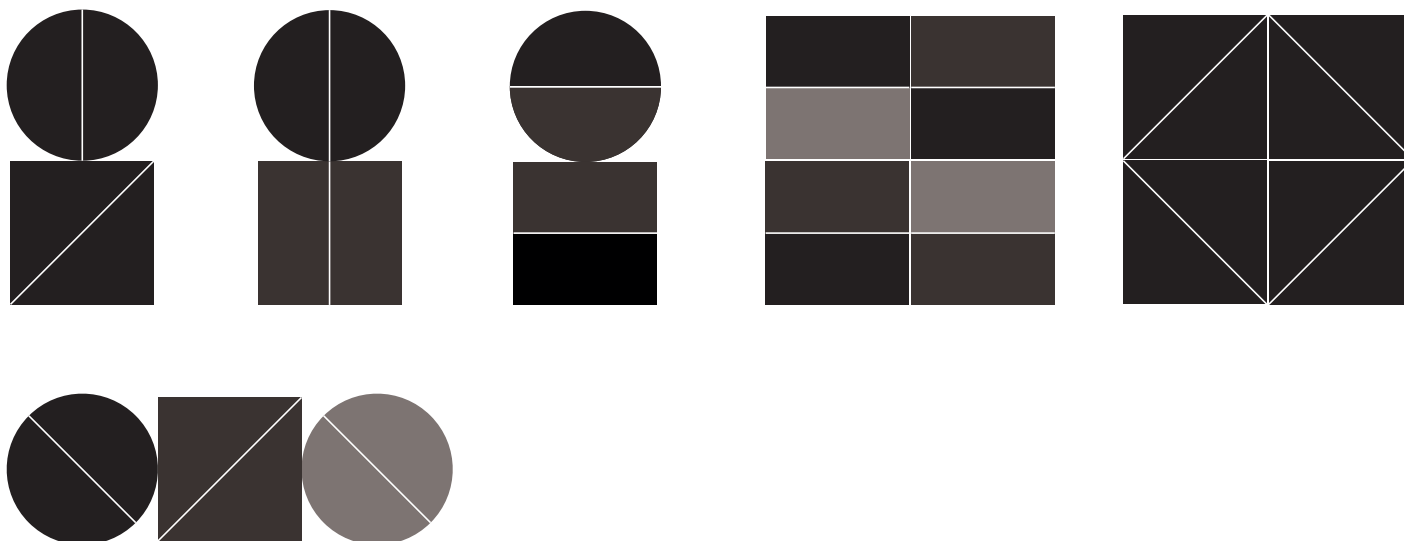

24% rabatt ska dras av på angivna priser

Parentesit Wall Panel

The sound absorbing Parentesit Wall Panel is made from an internal panel that has been tested and certified for its superior performance in absorbing ambient sound. In the testing process, to maximize the effectiveness of the sound absorbing Parentesit Wall Panel, upholstery options are available in fabrics that help to muffle sound, giving additional protection against environmental noise and increased opportunity for quiet, uninterrupted work.

1 The internal panel was tested in a controlled echo chamber according to the UNI EN ISO 354 standard. The results shown here indicate absorption coefficients for every frequency tested, demonstrating the efficacy of Parentesit to reduce noise under a broad range of frequencies.

2 According to the industry standard used to classify sound absorbing material, ISO 11654, the values of sound absorbing coefficients are expressed by α . This table shows the sound absorbing curves classified in classes from A to E, where A is the best.

Note: The sound absorbing characteristics are lost if it is upholstered with non breathable materials.

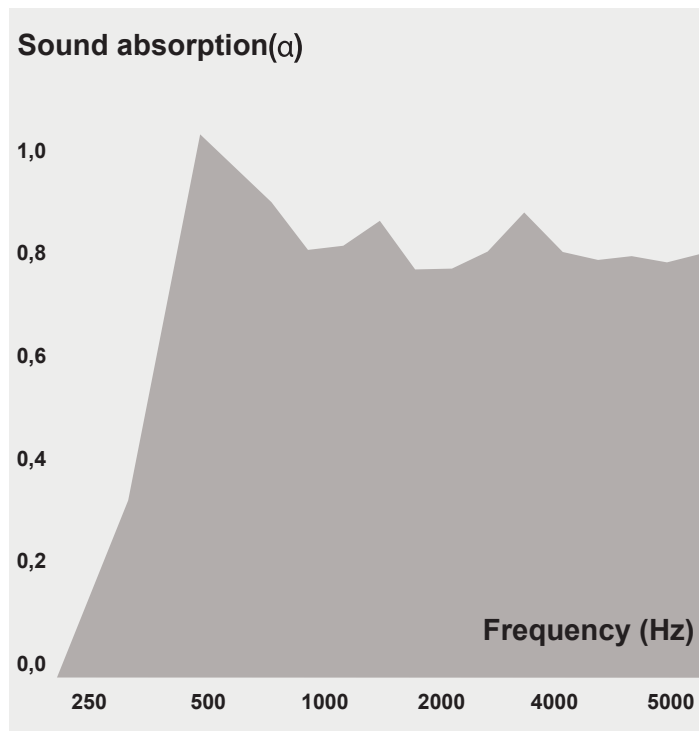

Example diagram

1

2

Sound absorption (α)	Sound absorption (α)	Sound absorption (α)
0,90	0,85	0,75
Fabrics: Jet Hallingdal 65 Tonus 4	Fabrics: Field 2 Revive 1 Remix 2	Fabrics: Canvas 2 Divina 3 Divina MD Divina Melange 2 Steelcut 2 Steelcut Trio 3
Absorption Class	Absorption Class	Absorption Class
A	B	C

24% rabatt ska dras av på angivna priser

Parentesit Freestanding

A private enclosure for collaborative work contexts. Freestanding Parentesit creates a retreat for individual, focused work or collaborative group discussions. Four versions — inset little circle, big circle, square, or circle and square combination — are each given structure and substance by a supportive frame. These modular pieces can be combined to create graphic expressions of archetypal forms or customized with color to generate bold compositions that articulate space and define shelter.

Composition examples

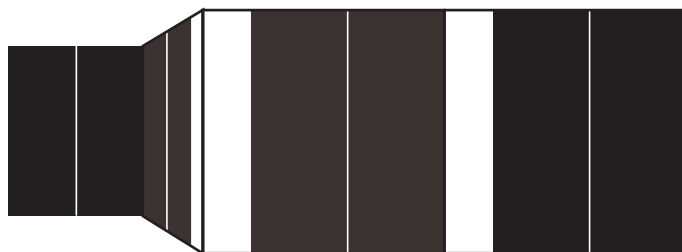
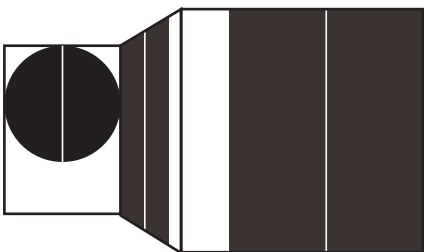
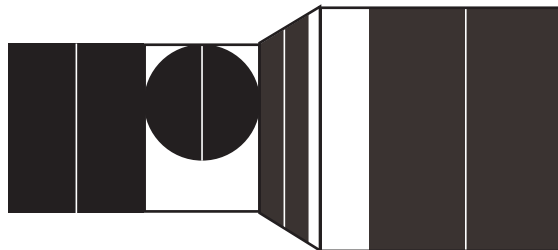
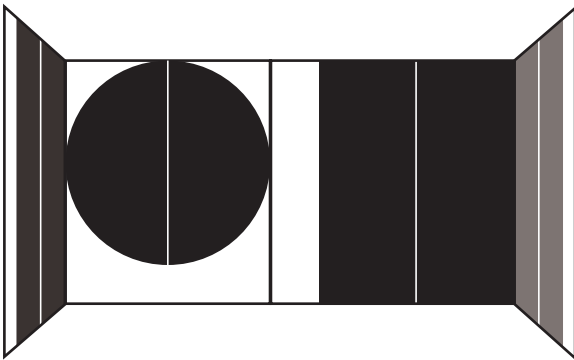
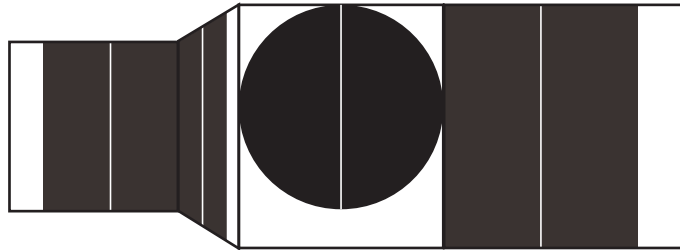

24% rabatt ska dras av på angivna priser

Parentesit Freestanding

Correct usage of plates and links

SINGLE MODULE

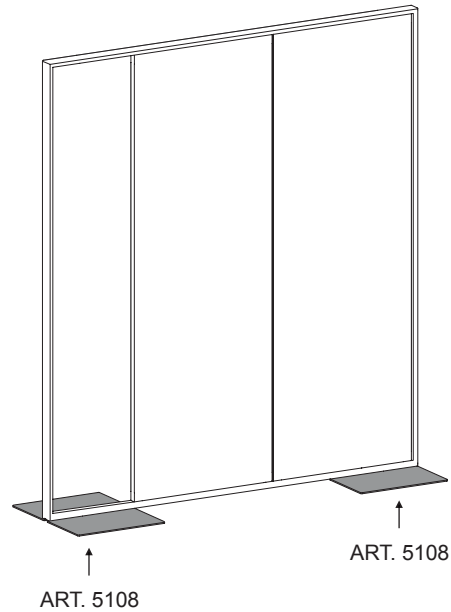

LINEAR MODULES

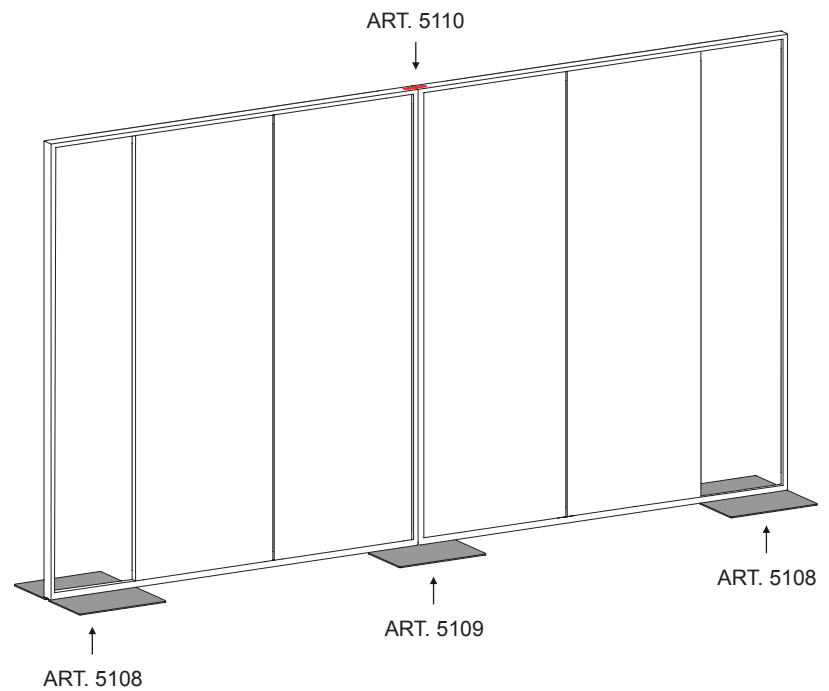

24% rabatt ska dras av på angivna priser

Parentesit Freestanding

"L" MODULES

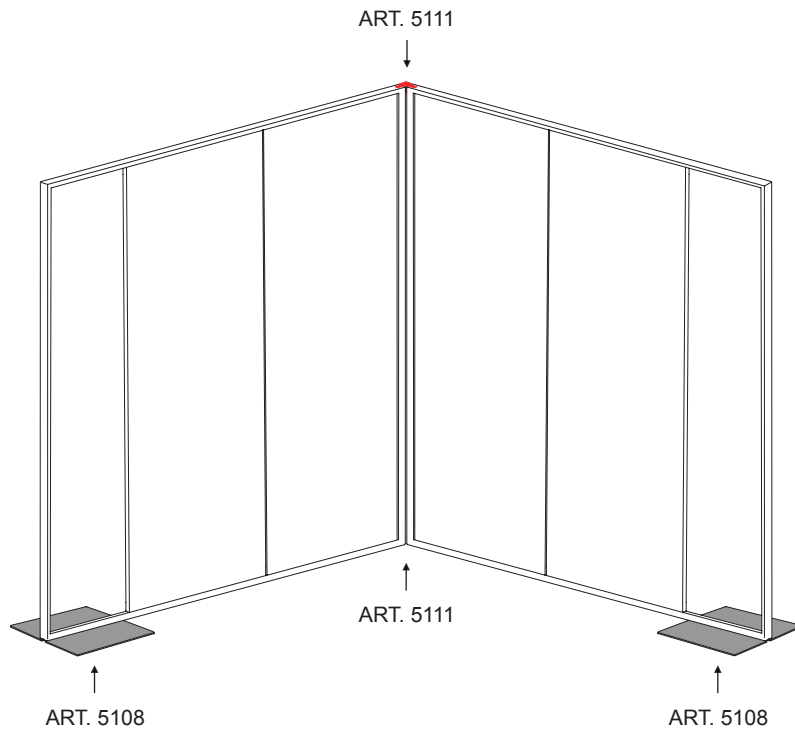

"T" MODULES

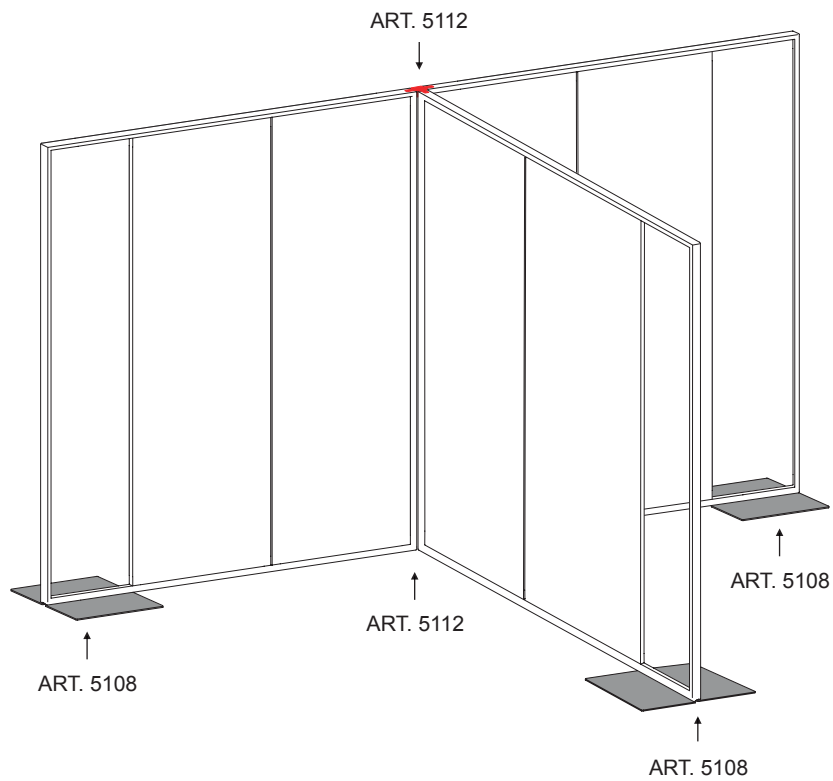

24% rabatt ska dras av på angivna priser

Parentesit Freestanding

"+" MODULES

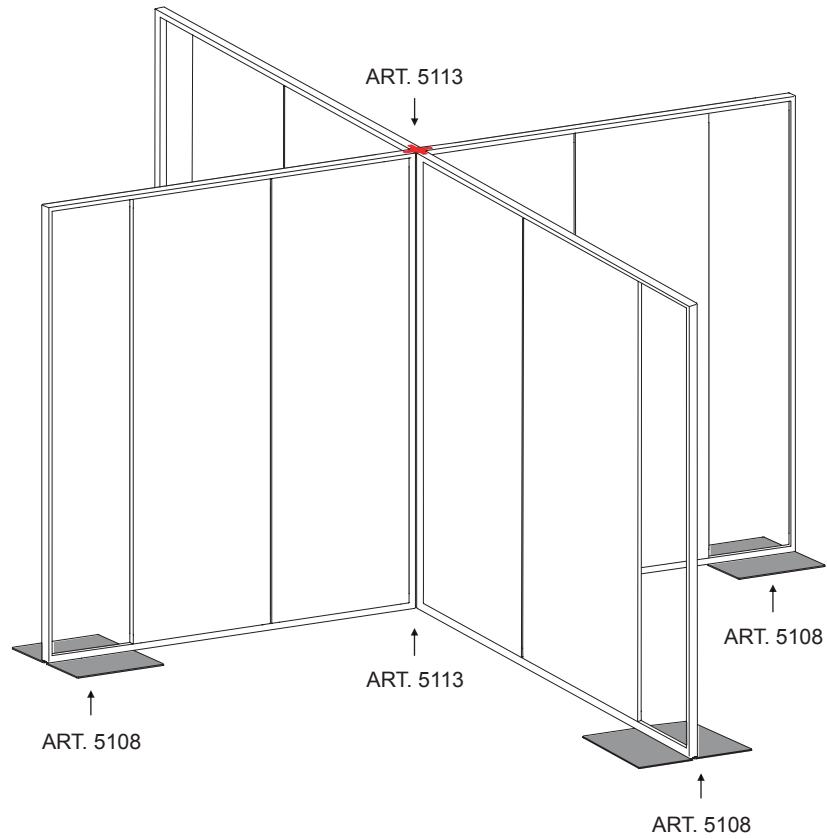

24% rabatt ska dras av på angivna priser

Parentesit Wall Panel

Design by Lievore Altherr Molina, 2015

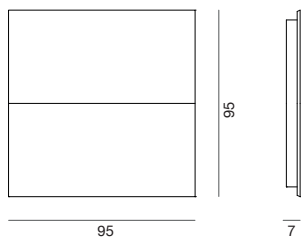

Decorative modular wall panel that is sound-absorbent and can be accessorised with a light, or audio + light system. Dimensions: 95 x 95 cm, available in one colour or two colours version, with horizontal insert (white or black). Electric cable not included.

SEK ART. 5100	A	B COM	C	D	E	F	G	H	I	J	K	L	M
Upholstered with a single material in one color	8456	8908	9360	9812	10264	10716	11168	11620	12072	12524	12976	13428	13880
Upholstered with a single material in two colors	+ 99	+ 165	+ 231	+ 297	+ 363	+ 429	+ 495	+ 561	+ 627	+ 693	+ 759	+ 825	+ 891
Optional LED light + speaker	+ 7409												
Optional LED light	+ 3462												

SHIPMENT DETAILS	TECHNICAL SPECIFICATIONS	RESISTANCE TEST
Art. 5100 1 pz = 1 - kg 14/ m³ 0,205 1 pz = 1 - kg 16,5/ m³ 0,205 1 pz = 1 - kg 16,8/ m³ 0,205 1 pz = 1 - kg 17,5/ m³ 0,205	Art.5100 H 140 cm. COM Meterage m 1.38 Acoustic performance: Sound absorption coefficient "A" pursuant to the ISO 11654 standard = equivalent sound absorption area for sound-absorbing packet in m2 * Contact the company for specific data = Sound Absorption Area per each type of panel Electrical/Audio/Lighting system: CE-marked product. The product has undergone very strict tests and obtained the most important European and international certifications.	
FIRE RETARDANT TEST		

24% rabatt ska dras av på angivna priser

Parentesit Wall Panel

Design by Lievore Altherr Molina, 2015

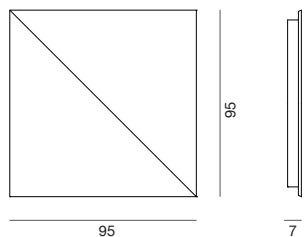

Decorative modular wall panel that is sound-absorbent and can be accessorised with a light, or audio + light system. Dimensions: 95 x 95 cm, available in one color or two colors version, with diagonal insert (white or black). Electric cable not included.

SEK ART. 5101	A	B COM	C	D	E	F	G	H	I	J	K	L	M
Upholstered with a single material in one color	8445	8842	9239	9636	10033	10430	10827	11224	11621	12018	12415	12812	13209
Upholstered with a single material in two colors	+ 551	+ 937	+ 1323	+ 1709	+ 2095	+ 2481	+ 2867	+ 3253	+ 3639	+ 4025	+ 4411	+ 4797	+ 5183
Optional LED light + speaker	+ 7409												
Optional LED light	+ 3462												

SHIPMENT DETAILS	TECHNICAL SPECIFICATIONS	RESISTANCE TEST
Art. 5101 1 pz = 1 - kg 14,5/ m² 0,205 1 pz = 1 - kg 17/ m² 0,205 1 pz = 1 - kg 17,3/ m² 0,205 1 pz = 1 - kg 18/ m² 0,205	Art.5101 H 140 cm. COM Meterage m 1.23 Acoustic performance: Sound absorption coefficient "A" pursuant to the ISO 11654 standard = equivalent sound absorption area for sound-absorbing packet in m2 * Contact the company for specific data = Sound Absorption Area per each type of panel Electrical/Audio/Lighting system: CE-marked product. The product has undergone very strict tests and obtained the most important European and international certifications.	
FIRE RETARDANT TEST		

24% rabatt ska dras av på angivna priser

Parentesit Wall Panel

Design by Lievore Altherr Molina, 2015

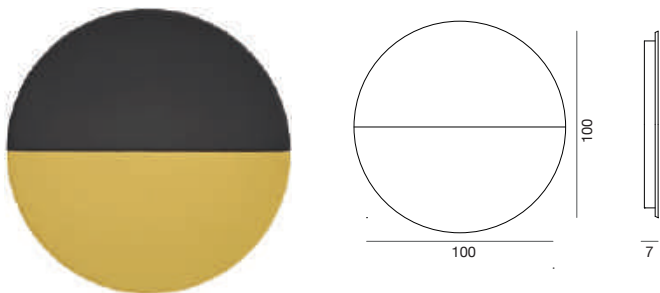

Decorative modular wall panel that is sound-absorbent and can be accessorised with a light, or audio + light system. Dimensions: Ø 100 cm, available in one color or two colors version, with central insert (white or black). Electric cable not included.

SEK ART. 5102	A	B COM	C	D	E	F	G	H	I	J	K	L	M
Upholstered with a single material in one color	8611	9085	9559	10033	10507	10981	11455	11929	12403	12877	13351	13825	14299
Upholstered with a single material in two colors	+ 33	+ 121	+ 209	+ 297	+ 385	+ 473	+ 561	+ 649	+ 737	+ 825	+ 913	+ 1001	+ 1089
Optional LED light + speaker	+ 6946												
Optional LED light	+ 2999												

SHIPMENT DETAILS	TECHNICAL SPECIFICATIONS	RESISTANCE TEST
Art. 5102 1 pz = 1 - kg 13/ m³ 0,205 1 pz = 1 - kg 15,5/ m³ 0,205 1 pz = 1 - kg 15,8/ m³ 0,205 1 pz = 1 - kg 16,8/ m³ 0,205	Art.5102 H 140 cm. COM Meterage m 1.35 Acoustic performance: Sound absorption coefficient "A" pursuant to the ISO 11654 standard = equivalent sound absorption area for sound-absorbing packet in m2 * Contact the company for specific data = Sound Absorption Area per each type of panel Electrical/Audio/Lighting system: CE-marked product. The product has undergone very strict tests and obtained the most important European and international certifications.	
FIRE RETARDANT TEST		

24% rabatt ska dras av på angivna priser

Parentesit

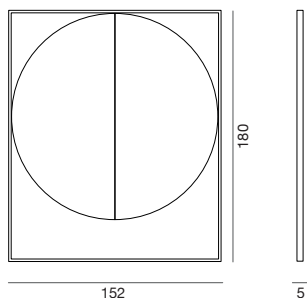
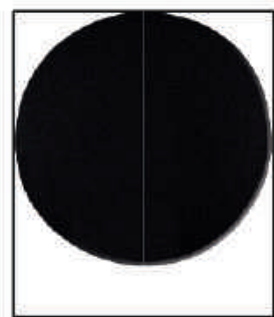

Design by Lievore Altherr Molina, 2016

Freestanding module made up of a round panel upholstered in one color fabric on a matt black metal base. The internal decorative panel as sound absorption features, it is also available in two color upholstery with a surcharge. Fixing plate and connection kit are supplied separately for the creation of modular compositions.

Accessories:

Link kit for "+" modules Art. 5113
Plate single junction Art. 5109

Link kit for "L" modules Art. 5111
Standard single plate Art. 5108

Link kit for "T" modules Art. 5112

Link kit for linear modules Art. 5110

SEK ART. 5105	A	B	COM	C	D	E	F	G	H	I	J	K	L	M
Upholstered with a single material in just one color	21333	22678	24023	25368	26713	28058	29403	30748	32093	33438	34783	36128	37473	
Upholstered with a single material in two colors: surcharge	+ 441	+ 728	+ 1015	+ 1302	+ 1589	+ 1876	+ 2163	+ 2450	+ 2737	+ 3024	+ 3311	+ 3598	+ 3885	
Set of glides for single pannel	+ 2194													

SHIPMENT DETAILS	TECHNICAL SPECIFICATIONS	RESISTANCE TEST
Art. 5105 1 pz = 3 - kg 39,7/ m ³ 0,177 1 pz = 4 - kg 58,7/ m ³ 0,184 	Art.5105 H 140 cm. COM Meterage m 9.81	
FIRE RETARDANT TEST		

Frame Base



V39
matt

24% rabatt ska dras av på angivna priser

Parentesit

Design by Lievore Altherr Molina, 2016

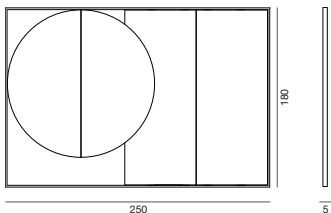

Freestanding module made up of a round and a square panel upholstered in one color fabric, with the choice of a different color for one panel, and resting on a matt black metal base. The internal decorative panels have sound absorption features. Fixing plate and connection kit are supplied separately for the creation of modular compositions.

Accessories:

Link kit for "+" modules Art. 5113
Plate single junction Art. 5109

Link kit for "L" modules Art. 5111
Standard single plate Art. 5108

Link kit for "T" modules Art. 5112

Link kit for linear modules Art. 5110

SEK ART. 5106	A	B COM	C	D	E	F	G	H	I	J	K	L	M
Upholstered with a single material in one/two colors	36736	39360	41984	44608	47232	49856	52480	55104	57728	60352	62976	65600	68224
Set of glides for single pannel	+ 2194												

SHIPMENT DETAILS	TECHNICAL SPECIFICATIONS	RESISTANCE TEST
Art. 5106 1 pz = 3 - kg 59/ m² 0,35 1 pz = 4 - kg 88/ m² 0,199 	Art.5106 H 140 cm. COM Meterage m 8.62	
FIRE RETARDANT TEST		

Frame Base



V39
matt

24% rabatt ska dras av på angivna priser

Parentesit

Design by Lievore Altherr Molina, 2016

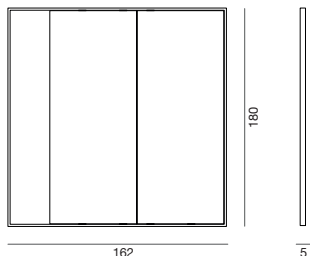

Freestanding module made up of a square panel upholstered in one color fabric on a matt black metal base. The internal decorative panel as sound absorption features, it is also available in two color upholstery with a surcharge. Fixing plate and connection kit are supplied separately for the creation of modular compositions.

Accessories:

Link kit for "+" modules Art. 5113
Plate single junction Art. 5109

Link kit for "L" modules Art. 5111
Standard single plate Art. 5108

Link kit for "T" modules Art. 5112

Link kit for linear modules Art. 5110

SEK ART. 5107	A	B COM	C	D	E	F	G	H	I	J	K	L	M	
Upholstered with a single material in just one color	20969	22248	23527	24806	26085	27364	28643	29922	31201	32480	33759	35038	36317	
Upholstered with a single material in two colors: surcharge	+ 33	+ 55	+ 77	+ 99	+ 121	+ 143	+ 165	+ 187	+ 209	+ 231	+ 253	+ 275	+ 297	
Set of glides for single pannel	+ 2194													

SHIPMENT DETAILS	TECHNICAL SPECIFICATIONS	RESISTANCE TEST
Art. 5107 1 pz = 3 - kg 46/ m² 0,166 1 pz = 4 - kg 65/ m² 0,173 	Art.5107 H 140 cm. COM Meterage m 8.12	
FIRE RETARDANT TEST		

Frame Base







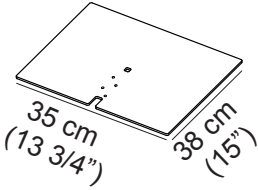
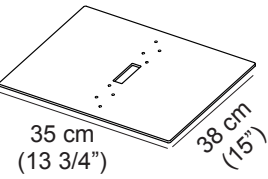
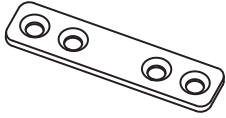
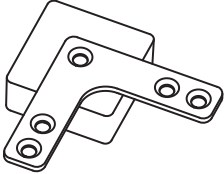
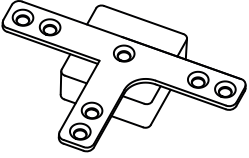
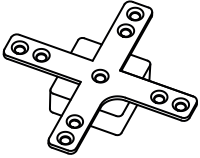

V39
matt

24% rabatt ska dras av på angivna priser

Accessories

Design by Lievore Altherr Molina, 2016

<p>SEK ART. 5108</p>  <p>35 cm (13 3/4") 38 cm (15")</p> <p>Standard single plate</p> <p>1103</p>	<p>SEK ART. 5109</p>  <p>35 cm (13 3/4") 38 cm (15")</p> <p>Plate single junction</p> <p>1103</p>	<p>SEK ART. 5110</p>  <p>Link kit for linear modules</p> <p>617</p>	<p>SEK ART. 5111</p>  <p>Link kit for "L" modules</p> <p>617</p>	<p>SEK ART. 5112</p>  <p>Link kit for "T" modules</p> <p>617</p>
<p>SEK ART. 5113</p>  <p>Link kit for "+" modules</p> <p>617</p>				

SHIPMENT DETAILS		TECHNICAL SPECIFICATIONS	
Art. 5108	1 pz = 1  - kg 9/ m ³ 0,07	Art. 5109	1 pz = 1  - kg 9/ m ³ 0,07
Art. 5110	1 pz = 1  - kg 1/ m ³ 0,004	Art. 5111	1 pz = 1  - kg 1/ m ³ 0,004
Art. 5112	1 pz = 1  - kg 1/ m ³ 0,004	Art. 5113	1 pz = 1  - kg 1/ m ³ 0,004
FIRE RETARDANT TEST			

24% rabatt ska dras av på angivna priser

24% rabatt ska dras av på angivna priser

FINISHES

24% rabatt ska dras av på angivna priser

Aava

Polipropilene
Polypropylene
Polypropylen
Polypropylène
Polipropileno

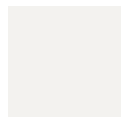

PG0001



PG0002



PG0003



PG0004



PG0005



PG0006

Adell

Polipropilene
Polypropylene
Polypropylen
Polypropylène
Polipropileno



PD00001



PD00002



PD00003



PD00004

Babar

Stelo ABS
Stem ABS
Stern ABS
Carénage colonne ABS
Soporte ABS

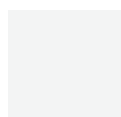

A11



A14

Babar

Cuscino in poliuretano
Cushion in polyurethane
Kissen in Polyurethan
Coussin en polyuréthane
Cojín en poliuretano

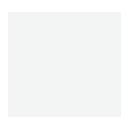

PU00001



PU00004

Catifa 46

Polipropilene monocolor
Polypropylene one colour
Polypropylen einfarbig
Polypropylène monocolor
Polipropileno monocolor

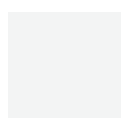

PO00101



PO00104



PO00105



PO00109



PO00112



PO00113



PO00114



PO00115



PO00116



PO00117



PO00118

Catifa 46

Polipropilene bicolor
Polypropylene two colors
Polypropylen zweifarbig
Polypropylène bicolor
Polipropileno bicolor



PO00204



PO00205



PO00209



PO00212



PO00213



PO00214



PO00215



PO00216



PO00217



PO00218

24% rabatt ska dras av på angivna priser

Catifa 53

Polipropilene monocolor
Polypropylene one colour
Polypropylen einfarbig
Polypropylène monocolor
Polipropileno monocolor

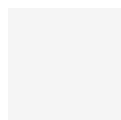

PO00401



PO00404



PO00409



PO00412



PO00413



PO00415



PO00419



PO00420

Cila & Cila Go

Polipropilene
Polypropylene
Polypropylen
Polypropylène
Polipropileno

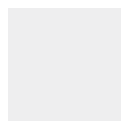

PC00001



PC00002



PC00003



PC00004



PC00005*

*non disponibile per base sgabello
*not available for the stool base
*nicht verfügbar für Hockergestell
*non disponible pour piètement tabouret
*no disponible para base de taburete

Duna 02

Polipropilene
Polypropylene
Polypropylen
Polypropylène
Polipropileno

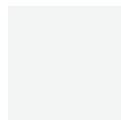

PP0001



PP0004



PP0005



PP0006

Juno 02

Polipropilene
Polypropylene
Polypropylen
Polypropylène
Polipropileno

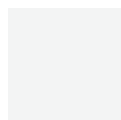

PT00011



PT00012



PT00013



PT00014



PT00015



PT00016

Kinesit

Polipropilene
Polypropylene
Polypropylen
Polypropylène
Polipropileno

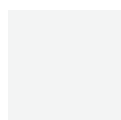

PA00001



PA00002

Leaf

Cuscino in poliuretano
Cushion in polyurethane
Kissen in Polyurethan
Coussin en polyuréthan
Cojín en poliuretano

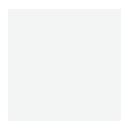

PU00001



PU00007



PU00008

24% rabatt ska dras av på angivna priser

Mixu

Polipropilene
Polypropylene
Polypropylen
Polypropylène
Polipropileno

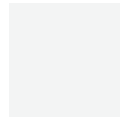

PM00001



PM00002



PM00003



PM00004



PM00005

Planesit

Polipropilene
Polypropylene
Polypropylen
Polypropylène
Polipropileno

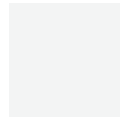

PA00001



PA00002

Stacy

Polipropilene
Polypropylene
Polypropylen
Polypropylène
Polipropileno

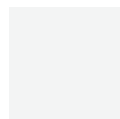

PS00001



PS00002



PS00003



PS00004



PS00005

24% rabatt ska dras av på angivna priser

Metalli
Metals
Metalle
Métal
Metal



CRO LU1 S03 V12 - matt / glossy V24 - matt V25 - matt



V39 - matt V44 - matt V54 - matt

Arcos

Metalli
Metals
Metalle
Métal
Metal



V39 - matt V59 - matt V60 - matt V61 - matt V62 - matt

Adell

Metalli
Metals
Metalle
Métal
Metal



V44 - matt V53 - matt V64 - matt

Catifa 46

Metalli
Metals
Metalle
Métal
Metal



CRO LU1 S03 V12 - matt V13 - matt V39 - matt



V48 - matt V53 - matt V54 - matt V55 - matt V56 - matt V57 - matt

Dizzie

Metalli
Metals
Metalle
Métal
Metal



V12 - glossy V34 - glossy V39 - glossy V39 - matt V48 - glossy V53 - glossy

Kinesit Met

Metalli
Metals
Metalle
Métal
Metal



V14 - matt V15 - matt V16 - matt

24% rabatt ska dras av på angivna priser

Leaf

Metalli
Metals
Metalle
Métal
Metal



V12 - matt



V13 - matt



V34 - matt

Mixu

Metalli
Metals
Metalle
Métal
Metal

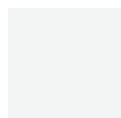

CRO



V25 - matt



V63 - matt



V65 - matt



V66 - matt

Oell

Metalli
Metals
Metalle
Métal
Metal



V44 matt

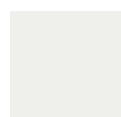

V12 matt



V53 matt



V63 matt

Pix table

Metalli
Metals
Metalle
Métal
Metal

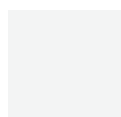

V12 - matt



V39 - matt

Stacy

Metalli
Metals
Metalle
Métal
Metal



CRO

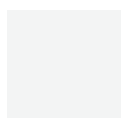

V12 - matt



V25 - matt



V57 - matt



V63 - matt

24% rabatt ska dras av på angivna priser

Dizzie Art. 0681

Top in MDF + laminato bianco
Top on MDF + laminate white
Tischplatte aus MDF + laminat weiß
Plateau en MDF + laminé blanc
Sobre de MDF + laminado blanco

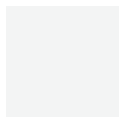

M02 - glossy



M34 - glossy



M39 - glossy



M48 - glossy



M53 - glossy

Dizzie

Marmo
Marble
Marmor
Marbre
Mármol



B01

Fenix®
fenixntm.com

Laminati
Laminate
Laminat
Laminé
Laminado

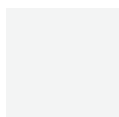

F01 - Fenix



F02 - Fenix



F06 - Fenix

Ghia

MDF



M08



M09

Ghia

Terrazzo
Venetian Terrazzo
Venezianische Terrazzo
Terrazzo vénitien
Terrazo

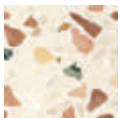

B10



B11

Leaf

Compact HPL

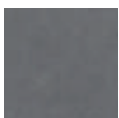

H04

Wim / Yop

Compact HPL

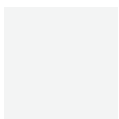

H02



H03

Meety / Wim / Yop

Nobilitato
Melamine
Melamin
Mélaminé
Melamínico

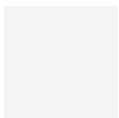

N01



N02

24% rabatt ska dras av på angivna priser

Oell

Gres Porcellanato
Porcelain Stoneware
Feinsteinzeug
Grès cérame
Gres porcelánico

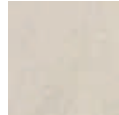

C10

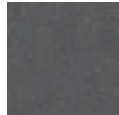

C11

Pix table

MDF

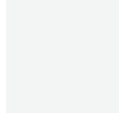

M02



M04

Saul

Vetro
Glass
Glas
Verre
Vidrio



V02

24% rabatt ska dras av på angivna priser

Legno
Wood
Holz
Bois
Madera



L0020



L0021



L0022



L0023

Aava

Betulla naturale
Natural birch effect
Effekt birke natur
Effect bouleau naturel
Efecto abedul natural



L0009

Aava

Betulla verniciata
Stained birch effect
Effekt birke lackiert
Effect bouleau verni
Efecto abedul pintado



L0010



L0011



L0012



L0013

Adell

Legno
Wood
Holz
Bois
Madera



L0006



L0022

Cross

Legno
Wood
Holz
Bois
Madera



L21



L22

Dizzie
Art. 0680



L0001



L0006



L0022

Family

Legno
Wood
Holz
Bois
Madera

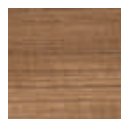

L14



L15



L21

Kata

Legno
Wood
Holz
Bois
Madera



L0006



L0022



L0023

24% rabatt ska dras av på angivna priser

Mixu

Legno
Wood
Holz
Bois
Madera



L0006



L0022

Ply

Legno
Wood
Holz
Bois
Madera



L0006



L0022

Saya

Legno
Wood
Holz
Bois
Madera



L0001



L0006



L0022



L0023

Steeve

Legno
Wood
Holz
Bois
Madera



LG00024

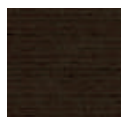

LG00025



LG00026

Wing



L14

Zinta

Legno
Wood
Holz
Bois
Madera



L0006



L0022



L0023

Kiik

Laminati
Laminate
Laminat
Laminé
Laminado

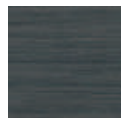

LM13

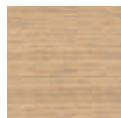

LM00022

Zinta

Laminati
Laminate
Laminat
Laminé
Laminado

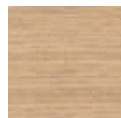

LM00022

24% rabatt ska dras av på angivna priser

Kata

Tessuto 3D Knit microimbottito con pattern grafico

3D Knit with graphic pattern

Mikrowattierter 3D-Knit-Stoff mit grafischem Muster

Tissu 3D Knit micro-rembourré avec motif graphique

Tejido 3D Knit microacolchado con patrón gráfico

グラフィックパターンのマイクロパッド入り3Dニットファブリック



LINEN - 3E00001

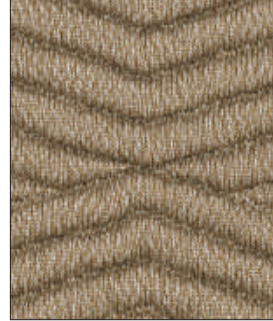

WHEAT - 3E00002



CHARCOAL - 3E00003

Kata

Tessuto 3D Knit con pattern a righe

3D Knit with striped pattern

3D-Knit-Stoff mit Streifenmuster

Tissu 3D Knit avec motif à rayures

Tejido 3D Knit con patrón de rayas

ストライプパターンの3Dニットファブリック

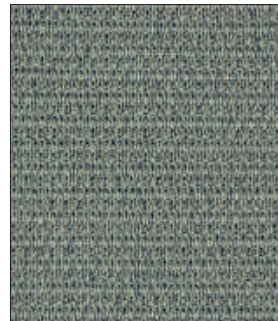

WATER - 3B00001

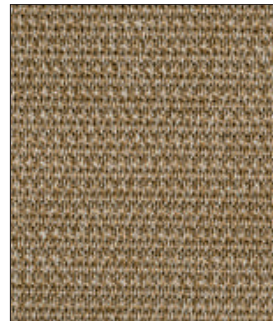

WHEAT - 3B00002



CHARCOAL - 3B00003

24% rabatt ska dras av på angivna priser

elmo[®]

CHROME FREE

ELMOSOFT è una pelle semi-anilina, morbida e flessibile. La sua morbidezza associata alla sua robustezza e ad una vasta gamma di colori disponibili rendono la pelle Elmosoft adatta ad un utilizzo nel contract. Punture di insetti e cicatrici visibili contribuiscono a valorizzare le caratteristiche di unicità ed eleganza di questa pelle.

ELMOSOFT is a soft and pliable Semi-Aniline leather. Outstanding comfort combined with excellent durability and an extensive shade card, makes it very suitable for the public environment. Visible insect-bites and scars from healed wounds add to the elegant quality of the leather.

ELMOSOFT. Weiches, geschmeidiges Semi-Anilinleder, Ein sehr strapazierfähiges und im Griff komfortables Leder in reicher Farbauswahl, hervorragend geeignet für Objektausstattungen. Sichtbar erhaltene Insektenstiche und kleine vernarbte Wunden betonen die naturechte Eleganz.

ELMOSOFT est un cuir semi-aniline, souple et doux. Son confort élevé, associé à une grande robustesse et à vste gamme de coloris disponibles, le rend particulièrement indiqué pour les collectivités. Les piqûres d'insectes et les cicatrices visibles contribuent à rehausser le caractère élégant du cuir.

ELMOSOFT es una piel semianilina suave y flexible. Su destacable confort combinado con excelente durabilidad y una amplia gama de colores, la hacen muy adecuada para ambientes públicos. Picaduras de insectos visibles y cicatrices de heridas contribuyen a valorar la elegante calidad de la piel.

Arper grade
CHAIRS: ES
SOFAS: ES

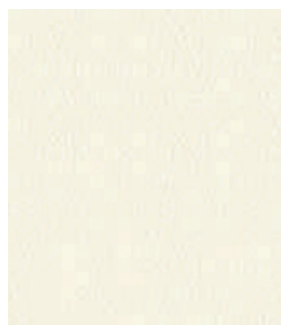

ES00100

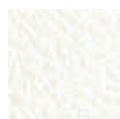

ES00109



ES00118



ES01003

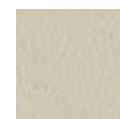

ES01021



ES01037



ES01043

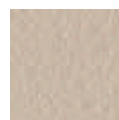

ES01061

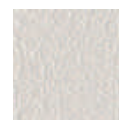

ES01085



ES02119



ES02122



ES05011



ES05029

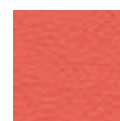

ES05145



ES07006



ES08021



ES08038



ES08055



ES08057



ES08124



ES11033



ES11049

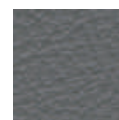

ES11056



ES11073



ES11152



ES13048



ES13072



ES13087



ES16003

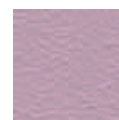

ES16377



ES17027



ES22024



ES22030



ES33001



ES33004



ES33077



ES35126



ES43054



ES43283



ES44012



ES45035



ES45065



ES46053



ES54021



ES54033



ES54035



ES55002



ES66006



ES71017



ES75010

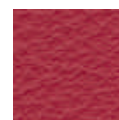

ES75011



ES75014



ES77074



24% rabatt ska dras av på angivna priser

elmo
CHROME FREE

ELMOSOFT è una pelle semi-anilina, morbida e flessibile. La sua morbidezza associata alla sua robustezza e ad una vasta gamma di colori disponibili rendono la pelle Elmosoft adatta ad un utilizzo nel contract. Punture di insetti e cicatrici visibili contribuiscono a valorizzare le caratteristiche di unicità ed eleganza di questa pelle.

ELMOSOFT is a soft and pliable Semi-Aniline leather. Outstanding comfort combined with excellent durability and an extensive shade card, makes it very suitable for the public environment. Visible insect-bites and scars from healed wounds add to the elegant quality of the leather.

ELMOSOFT. Weiches, geschmeidiges Semi-Anilinleder, Ein sehr strapazierfähiges und im Griff komfortables Leder in reicher Farbauswahl, hervorragend geeignet für Objektausstattungen. Sichtbar erhaltene Insektenstiche und kleine vernarbte Wunden betonen die naturechte Eleganz.

ELMOSOFT est un cuir semi-aniline, souple et doux. Son confort élevé, associé à une grande robustesse et à une vaste gamme de coloris disponibles, le rend particulièrement indiqué pour les collectivités. Les piqûres d'insectes et les cicatrices visibles contribuent à rehausser le caractère élégant du cuir.

ELMOSOFT es una piel semianilina suave y flexible. Su destacable confort combinado con excelente durabilidad y una amplia gama de colores, la hacen muy adecuada para ambientes públicos. Picaduras de insectos visibles y cicatrices de heridas contribuyen a valorar la elegante calidad de la piel.

Arper grade
CHAIRS: ES
SOFAS: ES

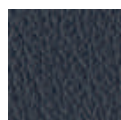

ES77127



ES77158



ES77237



ES78023



ES87021



ES88019



ES91102



ES93068

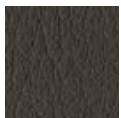

ES93099



ES93109



ES93129



ES95006



ES97038



ES98015



ES98047

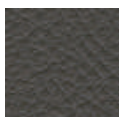

ES98087



ES99999

24% rabatt ska dras av på angivna priser

elmo®

NEOCOAST

Soft leather

Weichleder

Cuir souple

Piel

Arper grade

CHAIRS: H

SOFAS: H

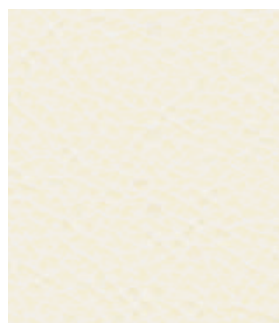

P400114



P402061



P412097



P418008



P443041

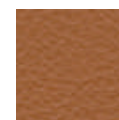

P443084



P444015

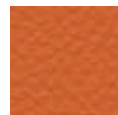

P445024



P455058

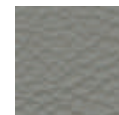

P471010



P477022



P477035



P488017

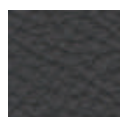

P491097

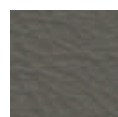

P491100

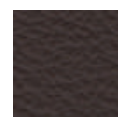

P493090

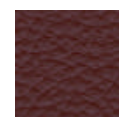

P495042

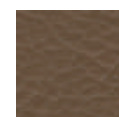

P498016

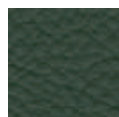

P498043

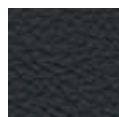

P499076

24% rabatt ska dras av på angivna priser

Pelle Fiore
Soft leather
Weichleder
Cuir souple
Piel

Arper grade
CHAIRS: I
SOFAS: I

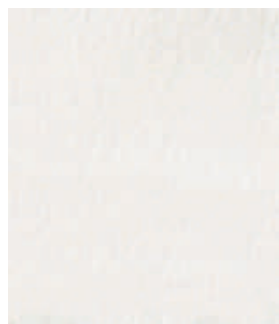

PF00001



PF00002



PF00003



PF00004



PF00006



PF00007

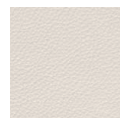

PF00008



PF00009



PF00010

Cuoio
Hard leather
Kernleder
Cuir
Cuero

Arper grade
CHAIRS: CT
SOFAS: CT

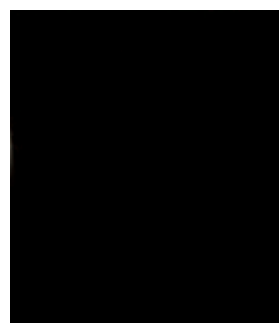

CT00020

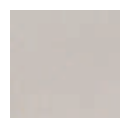

CT00031



CT00033



CT00034



CT00090



CT00120

Cuciture a contrasto standard
Standard contrast stitching
Standard Kontrastnähte
Surpiqûre standard à contrast
Costura contraste estándar

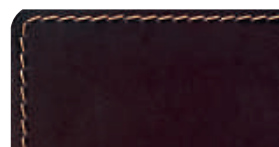

CT00120
Cucitura in ocre
Ochre stitching
Ockergelbe Nähte
Surpiqûre en Ocre
Costura ocre

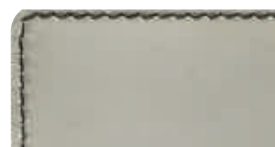

CT00031
Cucitura in grigio scuro
Dark grey stitching
Dunkelgraue Nähte
Surpiqûre en gris foncé
Costura gris obscuro

24% rabatt ska dras av på angivna priser



SPRADLING®

Valencia

Tessuto spalmato Valencia
Coated fabric Valencia
Beschichtete textilien Valencia
Tissus enduits Valencia
Tejido recubierto Valencia

Arper grade
CHAIRS: **B**
SOFAS: **B**

						
VL02020	VL00001	VL00002	VL00020	VL00033	VL00034	
						
VL02020	VL00035	VL01001	VL01020	VL01048	VL01049	
						
VL01050	VL02001	VL02002	VL02021	VL02062	VL02074	VL02075
						
VL02106	VL02107	VL02108	VL02109	VL02110	VL02111	VL02112
						
VL02113	VL02114	VL02115	VL02116	VL02117	VL02118	VL02119
						
VL03001	VL03067	VL03068	VL03069	VL04001	VL04002	VL04003
						
VL04020	VL04040	VL04041	VL04042	VL04043	VL04044	VL04045
						
VL04052	VL05001	VL05002	VL05041	VL05056	VL05057	VL05065



24% rabatt ska dras av på angivna priser



SPRADLING®
Silvertex

Arper grade
CHAIRS: **C**
SOFAS: **B**



 SX00001	 SX00002	 SX00005	 SX00009	 SX00013	 SX00073	
 SX01010	 SX01014	 SX01051	 SX01077	 SX01078		
 SX02003	 SX02011	 SX02012	 SX02016	 SX02064	 SX02089	 SX02090
 SX02091	 SX02092	 SX02093	 SX02094	 SX02095	 SX02096	 SX02097
 SX02098	 SX02099	 SX02100	 SX02101	 SX02102	 SX02103	 SX02104
 SX02105	 SX03001	 SX03007	 SX03066	 SX03067	 SX03068	 SX04001
 SX04002	 SX04003	 SX04004	 SX04010	 SX04011	 SX04012	 SX04024
 SX05008	 SX05009	 SX05010	 SX05019	 SX05020	 SX05063	 SX06004
 SX06061	 SX06062	 SX06065	 SX07001	 SX07002	 SX09001	 SX09002

arper

24% rabatt ska dras av på angivna priser

kvadrat

Atom

Arper grade
CHAIRS: **Atom**



AM00124

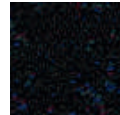

AM00194

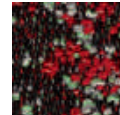

AM00574

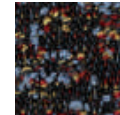

AM00774

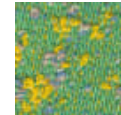

AM00944



AM00964

Available only for Adell collection.

kvadrat

Balder 3

Arper grade
CHAIRS: |
SOFAS: |
PANELS: |



B100132

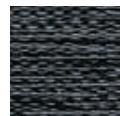

B100152



B100192

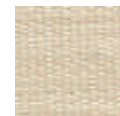

B100212



B100382



B100432

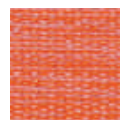

B100542



B100562



B100612

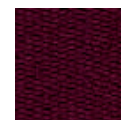

B100682



B100692

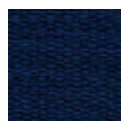

B100782

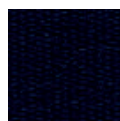

B100792

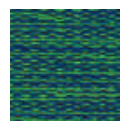

B100862



B100912



B100942

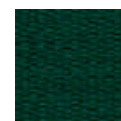

B100982



B101775



B102635

24% rabatt ska dras av på angivna priser

kvadrat

Canvas 2



Kvadrat's Canvas 2 has been awarded the EU Ecolabel

Arper grade
CHAIRS: D
SOFAS: F
PANELS: D



CV00114



CV00124



CV00134

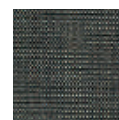

CV00154

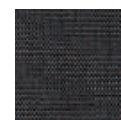

CV00174

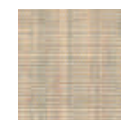

CV00216



CV00224

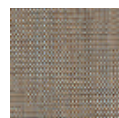

CV00244

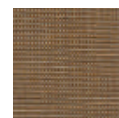

CV00254



CV00264

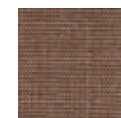

CV00356



CV00364



CV00374



CV00414

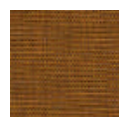

CV00424



CV00446

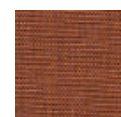

CV00454



CV00546



CV00556

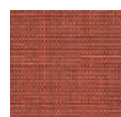

CV00566

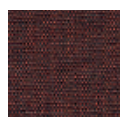

CV00576



CV00614



CV00644



CV00654



CV00666



CV00674

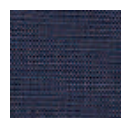

CV00684

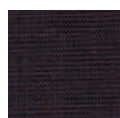

CV00694



CV00716



CV00726

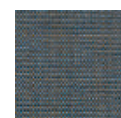

CV00734

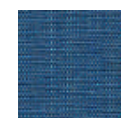

CV00746



CV00764

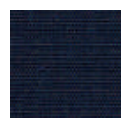

CV00786

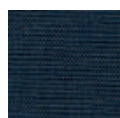

CV00794



CV00836

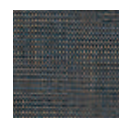

CV00854



CV00926



CV00936



CV00946



CV00954



CV00964

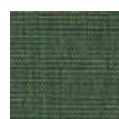

CV00974

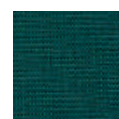

CV00984



CV00996

24% rabatt ska dras av på angivna priser

kvadrat

Divina 3



Kvadrat's Divina 3 has been awarded the EU Ecolabel

Arper grade
CHAIRS: G
SOFAS: I
PANELS: G

							
	DV00171	DV00106	DV00154	DV00173	DV00181	DV00191	
							
		DV00224	DV00236	DV00246	DV00334	DV00346	
							
DV00356	DV00376	DV00384	DV00393	DV00426	DV00444	DV00462	DV00526
							
DV00536	DV00542	DV00552	DV00562	DV00584	DV00623	DV00626	DV00636
							
DV00652	DV00662	DV00671	DV00666	DV00676	DV00684	DV00686	DV00691
							
DV00692	DV00696	DV00712	DV00742	DV00756	DV00782	DV00791	DV00793
							
DV00826	DV00836	DV00846	DV00856	DV00876	DV00886	DV00893	DV00922
							
DV00936	DV00944	DV00956	DV00966	DV00984			

24% rabatt ska dras av på angivna priser

kvadrat

Divina MD



Kvadrat's Divina MD has been awarded the EU Ecolabel

Arper grade
CHAIRS: G
SOFAS: I
PANELS: G

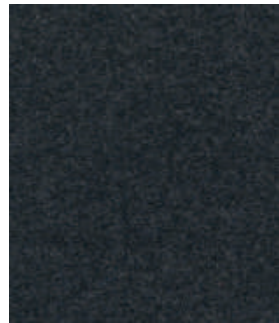

DI00193



DI00203



DI00213

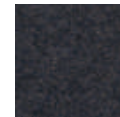

DI00293



DI00343

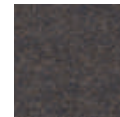

DI00353



DI00363



DI00413



DI00433



DI00453



DI00613



DI00633

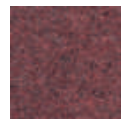

DI00653

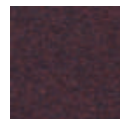

DI00673

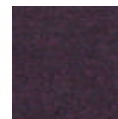

DI00683



DI00713



DI00733



DI00743



DI00753

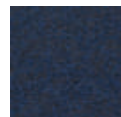

DI00773



DI00783



DI00813



DI00843



DI00873



DI00913



DI00943

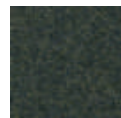

DI00973

24% rabatt ska dras av på angivna priser

kvadrat

Divina Melange 3



Kvadrat's Divina Melange 3 has been awarded the EU Ecolabel

Arper grade
CHAIRS: G
SOFAS: I
PANELS: G



DM00120

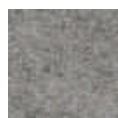

DM00147



DM00170



DM00180



DM00227



DM00237



DM00260



DM00277

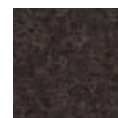

DM00280



DM00367



DM00427



DM00457



DM00467



DM00471



DM00517



DM00527



DM00547



DM00557



DM00567



DM00571



DM00581



DM00597



DM00617



DM00620



DM00647

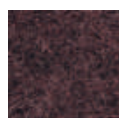

DM00677



DM00687



DM00731

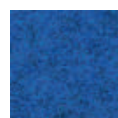

DM00747



DM00757



DM00777



DM00787



DM00821



DM00871



DM00917



DM00937



DM00967



DM00977

24% rabatt ska dras av på angivna priser

kvadrat

Field 2



Kvadrat's Field 2 has been awarded the EU Ecolabel

Arper grade
CHAIRS: B
SOFAS: C
PANELS: B

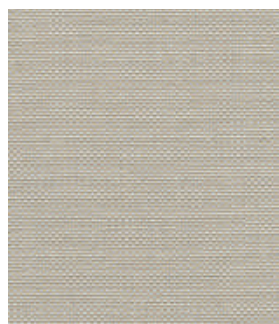

FI00123

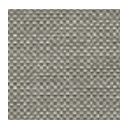

FI00132

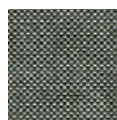

FI00142



FI00173



FI00182



FI00192

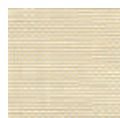

FI00222



FI00233



FI00242

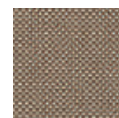

FI00343



FI00373



FI00443



FI00463



FI00623



FI00643



FI00662



FI00663



FI00673



FI00693

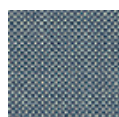

FI00723



FI00733



FI00763



FI00773



FI00782



FI00793

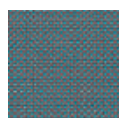

FI00843



FI00933



FI00943



FI00963



FI00983

24% rabatt ska dras av på angivna priser

kvadrat

Fiord 2 (EU Ecolabel)



Kvadrat's Fiord 2 has been awarded the EU Ecolabel

Arper grade
CHAIRS: F
SOFAS: F
PANELS: F



24% rabatt ska dras av på angivna priser

kvadrat Floyd

Arper grade
CHAIRS: C
SOFAS: C
PANELS: C



F100103



F100123



F100143

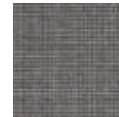

F100163

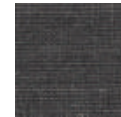

F100193



F100213



F100223



F100243



F100263



F100363



F100413



F100623



F100643



F100663



F100693



F100723



F100763



F100783

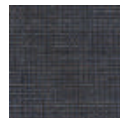

F100793



F100923



F100943



F100963



F100983

24% rabatt ska dras av på angivna priser

kvadrat

Hallingdal 65 (EU Ecolabel)



Kvadrat's Hallingdal 65 has been awarded the EU Ecolabel

Arper grade

CHAIRS: **G**

SOFAS: **G**

PANELS: **G(*)**



HA00103

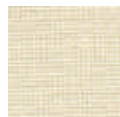

HA00100



HA00110

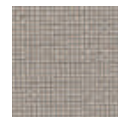

HA00113

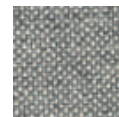

HA00116

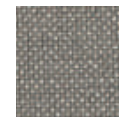

HA00123

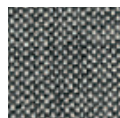

HA00126



HA00130



HA00143

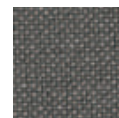

HA00153

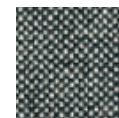

HA00166



HA00173



HA00180



HA00190

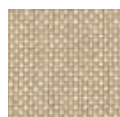

HA00200

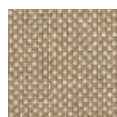

HA00220



HA00224

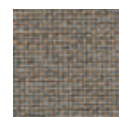

HA00227



HA00270

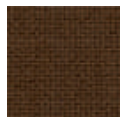

HA00350



HA00368



HA00370



HA00376



HA00390



HA00407

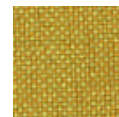

HA00420



HA00457

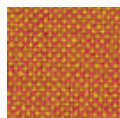

HA00526



HA00547



HA00563



HA00573

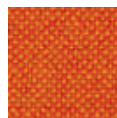

HA00590

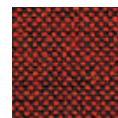

HA00596

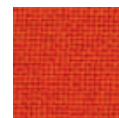

HA00600



HA00657



HA00660



HA00674



HA00680

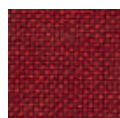

HA00687



HA00694



HA00702



HA00723

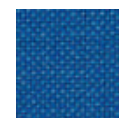

HA00733

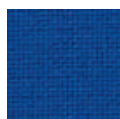

HA00750

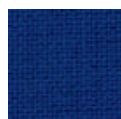

HA00753

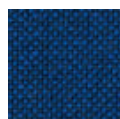

HA00754

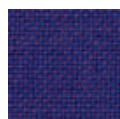

HA00763



HA00764



HA00773

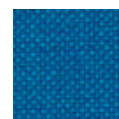

HA00810

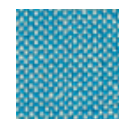

HA00840

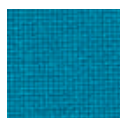

HA00850

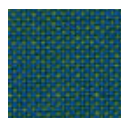

HA00890



HA00907



HA00944



HA00960

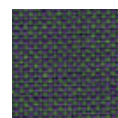

HA00968



HA00980

Not available for Paravan collection

24% rabatt ska dras av på angivna priser

kvadrat

Jaali



Kvadrat's Jaali has been awarded the EU Ecolabel

Arper grade
CHAIRS: **G**
SOFAS: **G**
PANELS: **G**

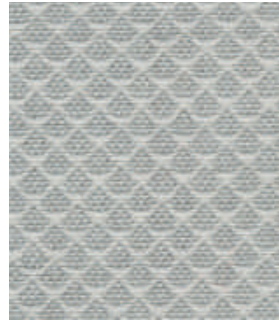

JA00101

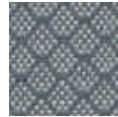

JA00121

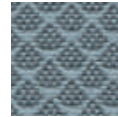

JA00141

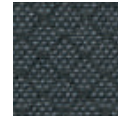

JA00171



JA00201

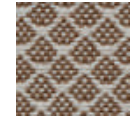

JA00341

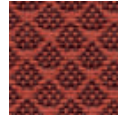

JA00561

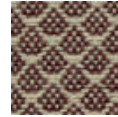

JA00571



JA00591

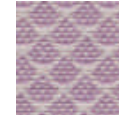

JA00611

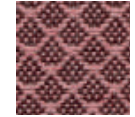

JA00651

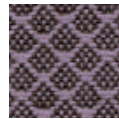

JA00671



JA00751

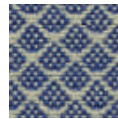

JA00761

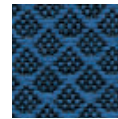

JA00781

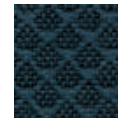

JA00791

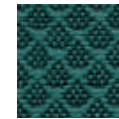

JA00871

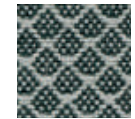

JA00951



JA00961



JA00991

24% rabatt ska dras av på angivna priser

kvadrat

Patio

Arper grade
CHAIRS: D
SOFAS: D

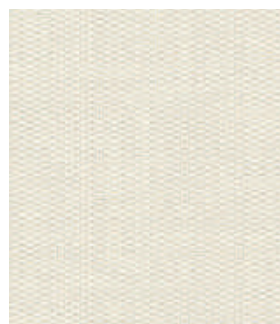

PT00100



PT00110

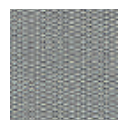

PT00140



PT00150

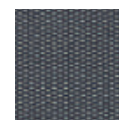

PT00170



PT00200



PT00210



PT00220



PT00230



PT00340



PT00370



PT00410



PT00430



PT00440

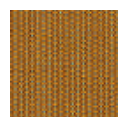

PT00450

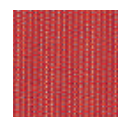

PT00550



PT00570

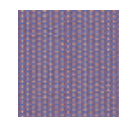

PT00650

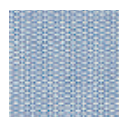

PT00730



PT00740

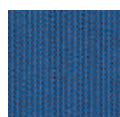

PT00750



PT00780

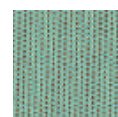

PT00840



PT00970

24% rabatt ska dras av på angivna priser

kvadrat

Re-wool



Kvadrat's Re-wool has been awarded the EU Ecolabel

Arper grade
CHAIRS: E
SOFAS: E
PANELS: E

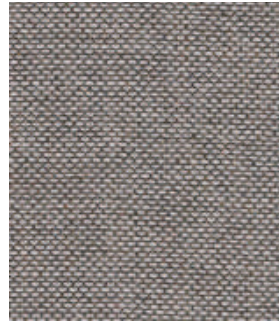

RW00108

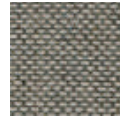

RW00128

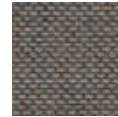

RW00158



RW00198

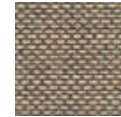

RW00218

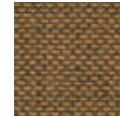

RW00358



RW00378

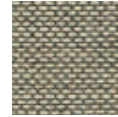

RW00408

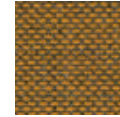

RW00448

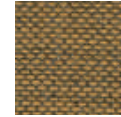

RW00458



RW00558



RW00568



RW00628



RW00648



RW00658



RW00718



RW00758



RW00768



RW00828



RW00858

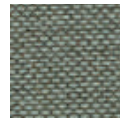

RW00868

24% rabatt ska dras av på angivna priser

kvadrat

Remix 3 (EU Ecolabel)



Kvadrat's Remix 3 has been awarded the EU Ecolabel

Arper grade
CHAIRS: C
SOFAS: D
PANELS: C

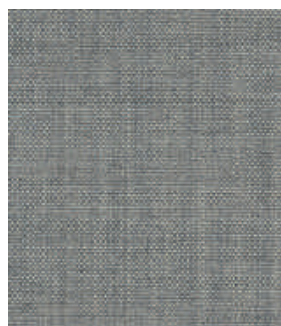

RX00123



RX00113 (*)



RX00126



RX00133



RX00136



RX00143



RX00152



RX00163

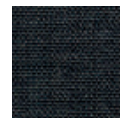

RX00173



RX00183



RX00196

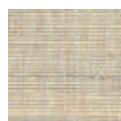

RX00223 (*)

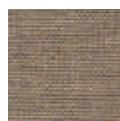

RX00233



RX00242



RX00252



RX00266



RX00276

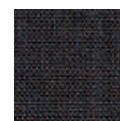

RX00286



RX00296



RX00326



RX00346



RX00356



RX00362



RX00373



RX00383

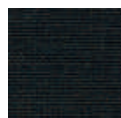

RX00393

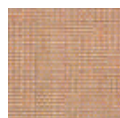

RX00406



RX00412



RX00422



RX00433



RX00443



RX00452



RX00516



RX00536



RX00543



RX00566



RX00606



RX00612



RX00632



RX00643



RX00653

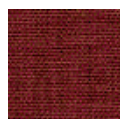

RX00662



RX00672

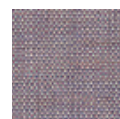

RX00682



RX00686



RX00692

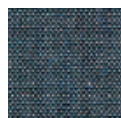

RX00716



RX00722

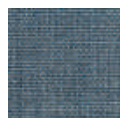

RX00733



RX00743



RX00753



RX00762



RX00773



24% rabatt ska dras av på angivna priser

kvadrat

Remix 3 (EU Ecolabel)



Kvadrat's Remix 3 has been awarded the EU Ecolabel

Arper grade
CHAIRS: C
SOFAS: D
PANELS: C



RX00783

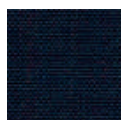

RX00796



RX00816



RX00836

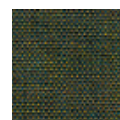

RX00842



RX00852



RX00866

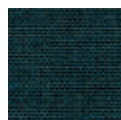

RX00873



RX00906



RX00912



RX00923



RX00933



RX00942

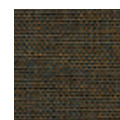

RX00954



RX00962



RX00973

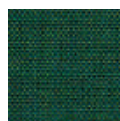

RX00982



RX00996

(*) RX00113 - RX00223: only for the cushions Owl, Lines, Pleats e Gego.

24% rabatt ska dras av på angivna priser

kvadrat

Revive 1

Arper grade
CHAIRS: **B**
SOFAS: **B**
PANELS: **B**



R100144

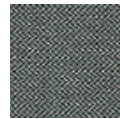

R100154

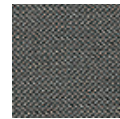

R100164



R100184



R100194



R100224



R100274



R100284

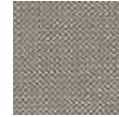

R100324



R100384



R100414



R100424



R100434



R100454



R100524



R100534



R100634



R100664



R100754



R100764



R100774



R100834



R100914



R100944



R100974

24% rabatt ska dras av på angivna priser

kvadrat
Ria

Arper grade
CHAIRS: Ria

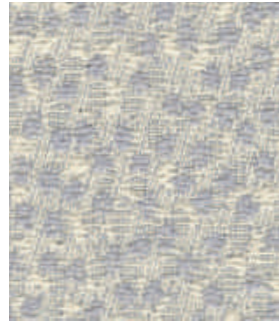

RA00111

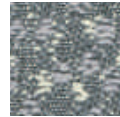

RA00141

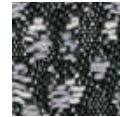

RA00181

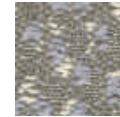

RA00241

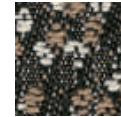

RA00281

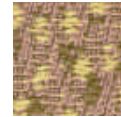

RA00431

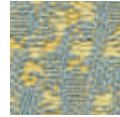

RA00441

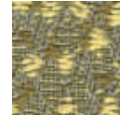

RA00451

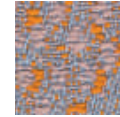

RA00541

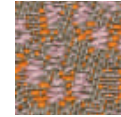

RA00551

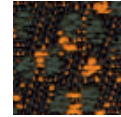

RA00591

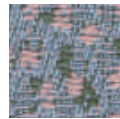

RA00741

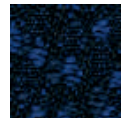

RA00791

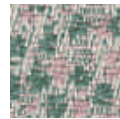

RA00921

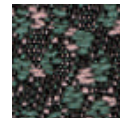

RA00981

Available only for Aston Club collection.

24% rabatt ska dras av på angivna priser

kvadrat

Sonar 3

Arper grade
CHAIRS: **Sonar**

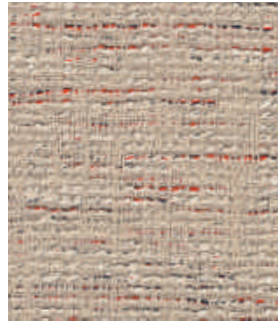

S700113



S700124

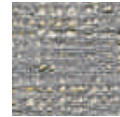

S700134

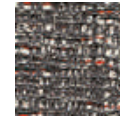

S700153

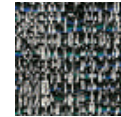

S700164

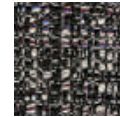

S700173

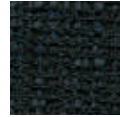

S700194

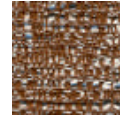

S700374

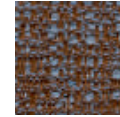

S700384



S700633

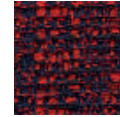

S700673



S700684

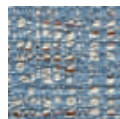

S700734

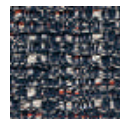

S700773



S700784



S700934



S700974

Available only for Aston Club collection.

24% rabatt ska dras av på angivna priser

kvadrat

Steelcut 3



Kvadrat's Steelcut 3 has been awarded the EU Ecolabel

Arper grade
CHAIRS: G
SOFAS: H
PANELS: G

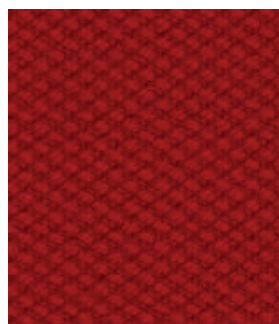

SE00545



SE00110



SE00120



SE00140



SE00155

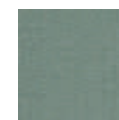

SE00160



SE00180

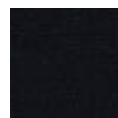

SE00190



SE00220



SE00240



SE00252



SE00265



SE00365



SE00402



SE00445



SE00452



SE00502



SE00512



SE00522



SE00535



SE00552



SE00562

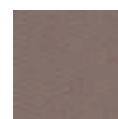

SE00605



SE00612



SE00655



SE00662



SE00672



SE00682



SE00695



SE00732



SE00742



SE00775



SE00780



SE00912

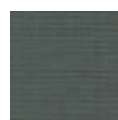

SE00922



SE00932



SE00962



SE00975



SE00985

24% rabatt ska dras av på angivna priser

kvadrat

Steelcut Trio 3



Kvadrat's Steelcut Trio 3 has been awarded the EU Ecolabel

Arper grade
CHAIRS: G
SOFAS: H
PANELS: G

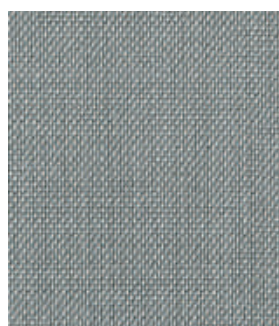

ST00113



ST00105



ST00124



ST00133

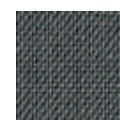

ST00153



ST00176

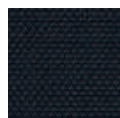

ST00195



ST00205



ST00213



ST00226



ST00236



ST00246



ST00253

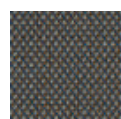

ST00266



ST00276



ST00283

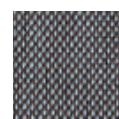

ST00336



ST00376



ST00383

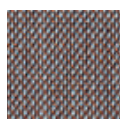

ST00416

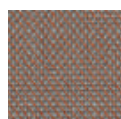

ST00426



ST00436



ST00446



ST00453



ST00466



ST00476

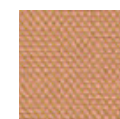

ST00506



ST00515



ST00526

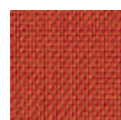

ST00533



ST00553



ST00576

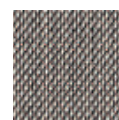

ST00616



ST00636



ST00645



ST00666

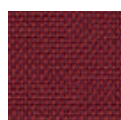

ST00686

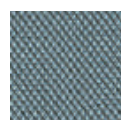

ST00713



ST00716



ST00746



ST00756



ST00776



ST00796



ST00806

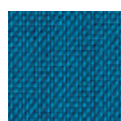

ST00865



ST00883



ST00906



ST00916



ST00946



ST00953

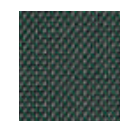

ST00966

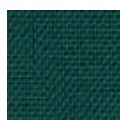

ST00976

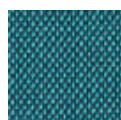

ST00983



ST00996

24% rabatt ska dras av på angivna priser

kvadrat

Tonus 4



Kvadrat's Tonus 4 has been awarded the EU Ecolabel

Arper grade
CHAIRS: F
SOFAS: G
PANELS: F



T300100



T300118



T300125



T300128



T300129



T300130



T300131



T300132



T300135



T300207



T300210



T300216



T300224



T300240



T300244



T300364



T300374



T300394



T300424



T300440



T300454



T300464



T300474



T300508



T300554



T300605



T300608



T300609



T300610



T300613



T300615



T300619



T300631



T300634



T300636



T300654



T300664



T300684



T300690



T300754



T300764



T300854



T300914



T300934



T300954



T300964



T300974

24% rabatt ska dras av på angivna priser

kvadrat

Vidar 4



Kvadrat's Vidar 4 has been awarded the EU Ecolabel

Arper grade

CHAIRS: J
SOFAS: J
PANELS: J



VD00106

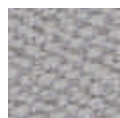

VD00123



VD00133



VD00143



VD00146

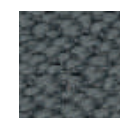

VD00152



VD00182

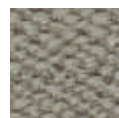

VD00222

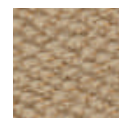

VD00323

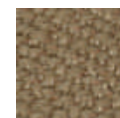

VD00333



VD00353

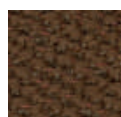

VD00363



VD00386



VD00443



VD00456



VD00472



VD00526



VD00542



VD00554



VD00556

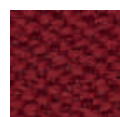

VD00582



VD00622



VD00633

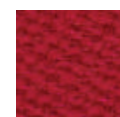

VD00653

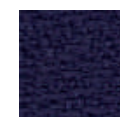

VD00656



VD00676

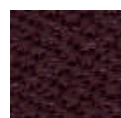

VD00693

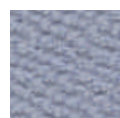

VD00723

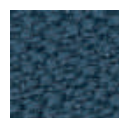

VD00733

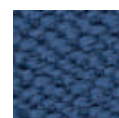

VD00743



VD00772



VD00786



VD00872

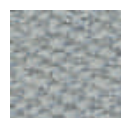

VD00913



VD00932



VD00943



VD00956



VD00972

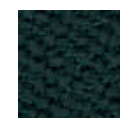

VD01062



VD01511



VD01880

24% rabatt ska dras av på angivna priser



Jet

Arper grade
CHAIRS: A
SOFAS: A
PANELS: A

						
JE00001 (*)	JE01001	JE01006	JE02010	JE02012	JE02024	
						
JE03019	JE03030	JE03036	JE03090	JE04007		
						
JE04017	JE04018	JE04027	JE04028	JE04051	JE06007	JE06013
						
JE06014	JE06056	JE06091	JE06095	JE06098	JE07014	JE07025
						
JE07034	JE07041	JE08001	JE08009	JE08017	JE08033	JE08078
						
JE09108	JE09109	JE09110	JE09219	JE09281	JE09294	JE009301
						
JE09302	JE09304	JE09305	JE09401	JE09402	JE09403	JE09404
						
JE09501	JE09600	JE09601	JE09602	JE09603	JE09604	JE09605

(*) Not available for Cila and Cila Go collections



24% rabatt ska dras av på angivna priser



Jet

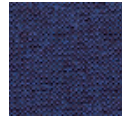

JE09606



JE09607



JE09608



JE09609



JE09610



JE09701

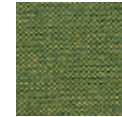

JE09702

Arper grade
CHAIRS: A
SOFAS: A
PANELS: A



JE09703



JE09704



JE09803

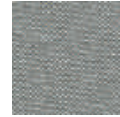

JE09804

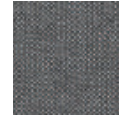

JE09805



JE09806

(*) Not available for Cila and Cila Go collections

24% rabatt ska dras av på angivna priser

camira

Main Line Flax

Arper grade
CHAIRS: C
SOFAS: C
PANELS: C

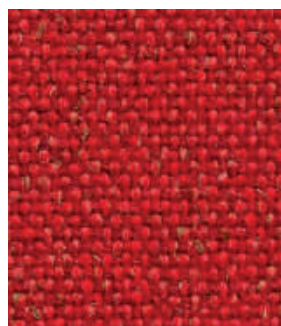

MFMLF01



MFMLF02



MFMLF03



MFMLF05



MFMLF06



MFMLF07



MFMLF08



MFMLF09

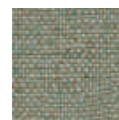

MFMLF10

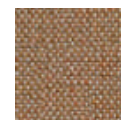

MFMLF12

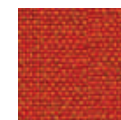

MFMLF13



MFMLF14



MFMLF15



MFMLF16



MFMLF17

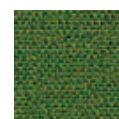

MFMLF18

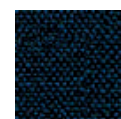

MFMLF19



MFMLF20



MFMLF21



MFMLF22



MFMLF23



MFMLF24



MFMLF25



MFMLF26



MFMLF28



MFMLF29



MFMLF31



MFMLF32

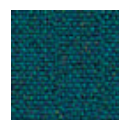

MFMLF34



MFMLF35



MFMLF36



MFMLF37



MFMLF40



MFMLF43



MFMLF44



MFMLF45



MFMLF46

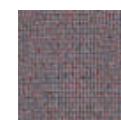

MFMLF47



MFMLF48



MFMLF49



MFMLF50



MFMLF51



MFMLF52

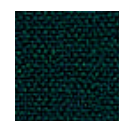

MFMLF53



MFMLF54

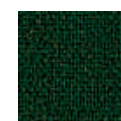

MFMLF55



MFMLF56



MFMLF57

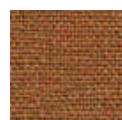

MFMLF59



MFMLF60



MFMLF61



MFMLF62



MFMLF63



MFMLF64



MFMLF65



MFMLF66

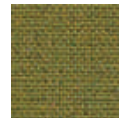

MFMLF67

24% rabatt ska dras av på angivna priser

camira

Phoenix

Arper grade
CHAIRS: A
SOFAS: A
PANELS: A



PHYP005



PHYP009



PHYP011



PHYP019



PHYP026



PHYP045



PHYP046



PHYP051



PHYP076



PHYP081



PHYP082



PHYP084



PHYP097



PHYP100



PHYP105



PHYP106



PHYP107



PHYP108



PHYP110



PHYP112



PHYP113

24% rabatt ska dras av på angivna priser

camira
Synergy

Arper grade
CHAIRS: C
SOFAS: C
PANELS: C



+ →

24% rabatt ska dras av på angivna priser

camira
Synergy

Arper grade
CHAIRS: C
SOFAS: C
PANELS: C



SNLDS67



SNLDS68



SNLDS69



SNLDS70



SNLDS71



SNLDS72



SNLDS73



SNLDS74

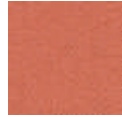

SNLDS75

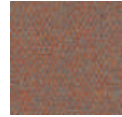

SNLDS76



SNLDS77



SNLDS78



SNLDS79



SNLDS80



SNLDS81



SNLDS82



SNLDS84



SNLDS85



SNLDS86



SNLDS87



SNLDS88

24% rabatt ska dras av på angivna priser

camira

Urban

Arper grade

CHAIRS: **B**

SOFAS: **B**

PANELS: **B**

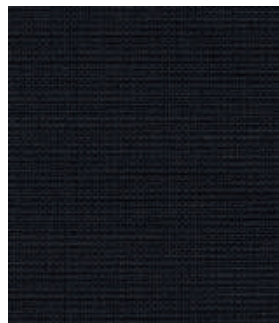

UPYN009



UPYN027



UPYN076



UPYN079



UPYN082



UPYN083



UPYN091



UPYN094

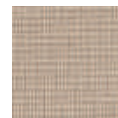

UPYN108

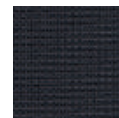

UPYN145



UPYN148



UPYN159



UPYN160



UPYN200



UPYN202



UPYN203



UPYN204



UPYN205



UPYN206

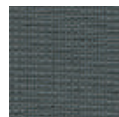

UPYN207



UPYN208

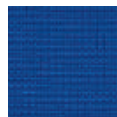

UPYN209



UPYN210



UPYN211



UPYN212

24% rabatt ska dras av på angivna priser

Gabriel
Rhythm



PA00001
(Gabriel 60000)

Only for Kinesit e Planesit.



PA00002
(Gabriel 60999)

24% rabatt ska dras av på angivna priser

maharam
Messenger

Arper grade
CHAIRS: D
SOFAS: D
PANELS: D



MS00001

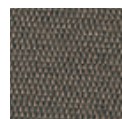

MS00007



MS00008

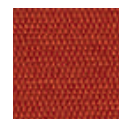

MS00024



MS00025

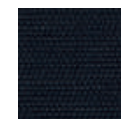

MS00029

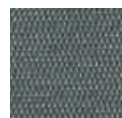

MS00031



MS00038

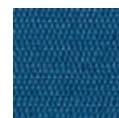

MS00040

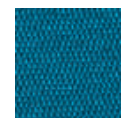

MS00041



MS00045



MS00046



MS00048

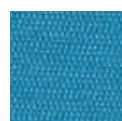

MS00050



MS00051

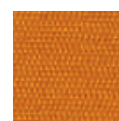

MS00053



MS00054

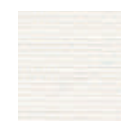

MS00058



MS00060



MS00061

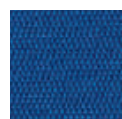

MS00062



MS00063



MS00066



MS00067

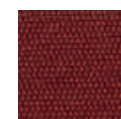

MS00069

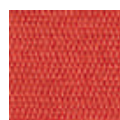

MS00070

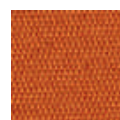

MS00071

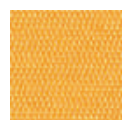

MS00072



MS00076

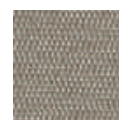

MS00077



MS00078



MS00079



MS00080

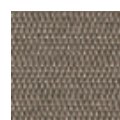

MS00081



MS00082



MS00083



MS00084



MS00085



MS00086

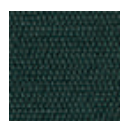

MS00087



MS00088



MS00089



MS00090



MS00091



MS00092



MS00093

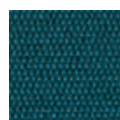

MS00094



MS00095

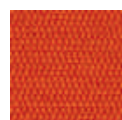

MS00096

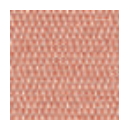

MS00097

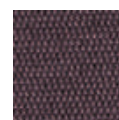

MS00098

24% rabatt ska dras av på angivna priser



Sera

Arper grade
CHAIRS: Sera

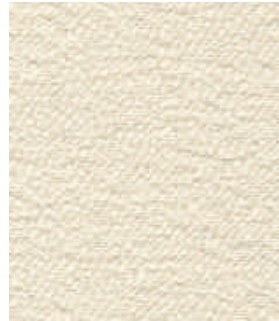

S800001

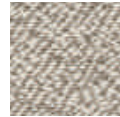

S800002



S800003

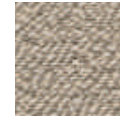

S800004



S800005

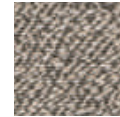

S800006



S800007

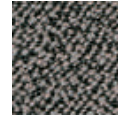

S800008

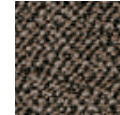

S800009



S800010



S800011

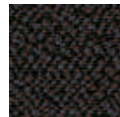

S800012



S800013



S800014

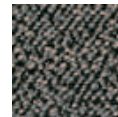

S800015

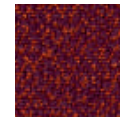

S800016

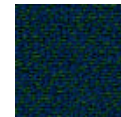

S800017

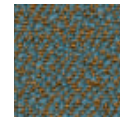

S800018

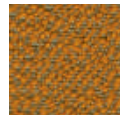

S800019

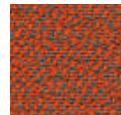

S800020



S800021

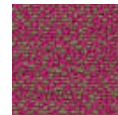

S800022

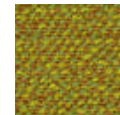

S800023

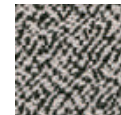

S800027

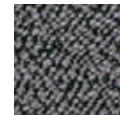

S800028

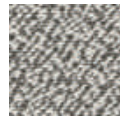

S800029

Available only for Aston Club collection.

24% rabatt ska dras av på angivna priser



Arper grade
CHAIRS: **Fabthirty**



FB00001



FB00002

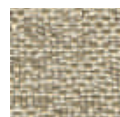

FB00003

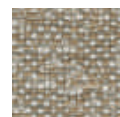

FB00004

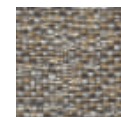

FB00005

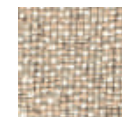

FB00006

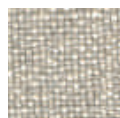

FB00007

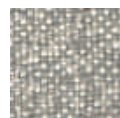

FB00008

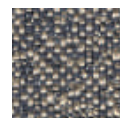

FB00009

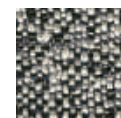

FB00010



FB00011

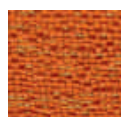

FB00012



FB00013

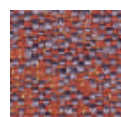

FB00014



FB00015



FB00016



FB00017

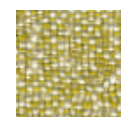

FB00018

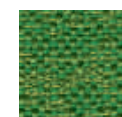

FB00019

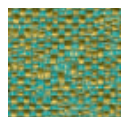

FB00020

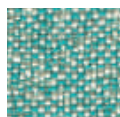

FB00021

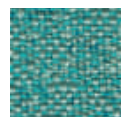

FB00022

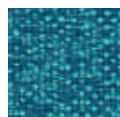

FB00023

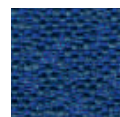

FB00024

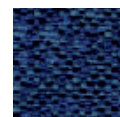

FB00025



FB00026

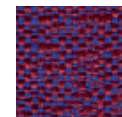

FB00027

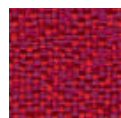

FB00028

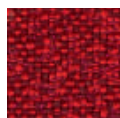

FB00029



FB00030



FB00031

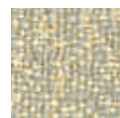

FB00032

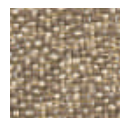

FB00033

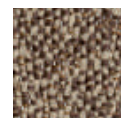

FB00034

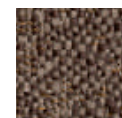

FB00035

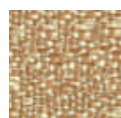

FB00036

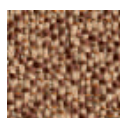

FB00037



FB00038

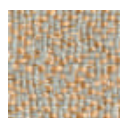

FB00039

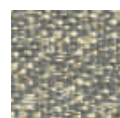

FB00040

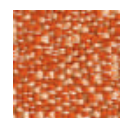

FB00041

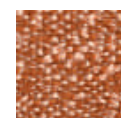

FB00042

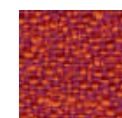

FB00043

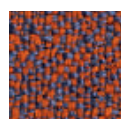

FB00044

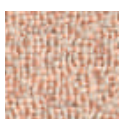

FB00045

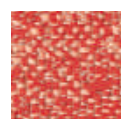

FB00046

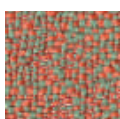

FB00047



FB00048

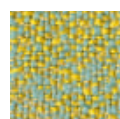

FB00049

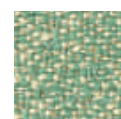

FB00050

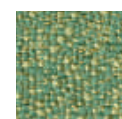

FB00051



FB00052

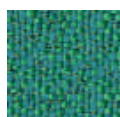

FB00053

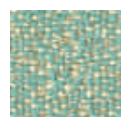

FB00054

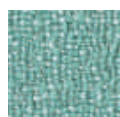

FB00055

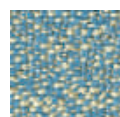

FB00056

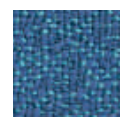

FB00057

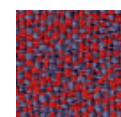

FB00058

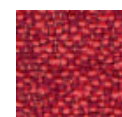

FB00059

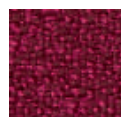

FB00060

Available only for Aston Club collection.

24% rabatt ska dras av på angivna priser

Heritage

Arper grade
CHAIRS: C
SOFAS: C



HE00001



HE00006



HE00009



HE00011

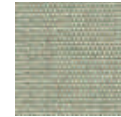

HE00012

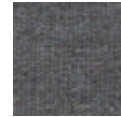

HE00015



HE00016



HE00017



HE00018



HE00021



HE00022



HE00023

Savane

Arper grade
CHAIRS: C
SOFAS: C

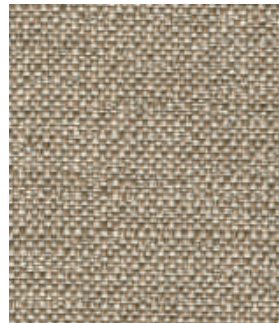

SV00233

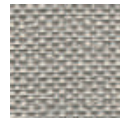

SV00234



SV00235

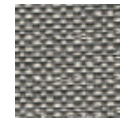

SV00236

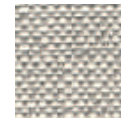

SV00349

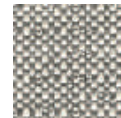

SV00350

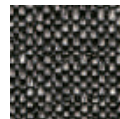

SV00351

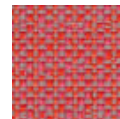

SV00352



SV00353



SV00354



SV00355

24% rabatt ska dras av på angivna priser



Istituito nel 1992, il marchio comunitario di qualità ecologica o Ecolabel, il cui logo è rappresentato da un fiore, è uno speciale sistema di certificazione creato per aiutare i consumatori europei a scegliere prodotti e servizi più ecologici e più rispettosi dell'ambiente.

Established in 1992, the EU Eco-label "Flower" is a unique certification scheme aimed to help European consumers distinguish greener, more environmentally friendly, products and services.

Hinter der "Blume", dem 1992 ins Leben gerufenen EU-Umweltzeichen, steckt ein einzigartiges Zertifizierungssystem, das dem europäischen Verbraucher das Erkennen umweltfreundlicherer Produkte und Dienstleistungen erleichtern soll.

Établi en 1992, le label écologique de l'EU symbolisé par la "Fleur" est un système d'homologation unique destiné à aider les consommateurs européens à discerner les produits et services plus verts et plus favorables à l'environnement.

Creada en 1992, la etiqueta ecológica de la UE, también conocida como "la flor", constituye un sistema de certificación único, cuyo objetivo es ayudar a los consumidores europeos a identificar los productos y servicios más ecológicos y respetuosos del medio ambiente.

24% rabatt ska dras av på angivna priser

Finishes – Colors correspondence chart

Materials	Description	Colour	Glossy	Matt	Semi-gloss
ABS					
A11	White	RAL 9003			
A14	Black	RAL 9004			
Polyurethane					
PU00001	White	RAL 9003			
PU00004	Black	RAL 9004			
PU00007	Moka	RAL 8019			
PU00008	Green	PANTONE 390			
Polypropylene					
PA00001	White	RAL 9003			
PA00002	Black	RAL 9005			
PC00001	White	NCS S 0500-N		X	
PC00002	Black	NCS S 8500-N		X	
PC00003	Terracotta	NCS S 3020-Y70R		X	
PC00004	Rust	NCS S 4040-Y70R		X	
PC00005	Clear Blue/grey	NCS S 4005-B80G		X	
PD00001	Ivory	NCS S 2005-Y20R			
PD00002	Bark brown	NCS S 7005-Y80R			
PD00003	Olive green	NCS S 6010-G90Y			
PD00004	Black	NCS S 8500-N			
PG0001	White	NCS S 0500-N			
PG0002	Sand	NCS S 2500-Y20R			
PG0003	Sage green	NCS S 3010-G20Y			
PG0004	Blue grey	NCS S 4020-R90B			
PG0005	Yellow	NCS S 2070-Y			
PG0006	Black	NCS S 8500-N			
PM00001	White	NCS S 0500-N			
PM00002	Black	NCS S 8500-N			
PM00003	Rust	NCS S 4040-Y70R			
PM00004	Olive green	NCS S 6010-G90Y			
PM00005	Dark blue	NCS S 8010-R90B			

24% rabatt ska dras av på angivna priser

Materials	Description	Colour	Glossy	Matt	Semi-gloss
PP0001	White	RAL 9003			
PP0004	Turtledove grey	NCS S 4005Y20R			
PP0005	Anthracite	NCS S 7500-N			
PP0006	Black	RAL 9004			
PS00001	White	RAL 9003			
PS00002	Black	NCS S8500-N			
PS00003	Petrol	NCS S4010-B50G			
PS00004	Rust	NCS S4040-Y70R			
PS00005	Ivory	NCS S2005-Y20R			
PT00011	White	NCS S 1002-Y			
PT00012	Sage green	NCS S 3010-G20Y			
PT00013	Rust	NCS S 4040-Y70R			
PT00014	Turtledove grey	NCS S 4005-Y20R			
PT00015	Anthracite	NCS S 6502-G			
PT00016	Black	NCS S 8500-N			
Monocolour					
PO00101	White	RAL 9003			
PO00104	Dark brown	RAL 8019			
PO00105	Red	RAL 3020			
PO00109	Black	RAL 9004			
PO00112	Anthracite	NCS S 7500-N			
PO00113	Ivory	NCS S 2500-Y20R			
PO00114	Turtledove grey	NCS S 4500-Y20R			
PO00115	Yellow	NCS S 4500-G20Y			
PO00116	Rosé	NCS S 3020-Y80R			
PO00117	Petrol	NCS S 4010-B50G			
PO00118	Green	PANTONE 390 U			
PO00401	White	RAL 9003		X	
PO00404	Dark brown	RAL 8019		X	
PO00409	Black	RAL 9004		X	
PO00412	Anthracite	NCS S 7500-N		X	
PO00413	Ivory	NCS S 2005-Y20R		X	
PO00415	Yellow	NCS S 1070-G90Y		X	
PO00419	Caramel	NCS 4040-Y30R		X	
PO00420	Sand	RAL 1001		X	

24% rabatt ska dras av på angivna priser

Materials	Description	Colour	Glossy	Matt	Semi-gloss
Bicolour					
PO00204	White-dark brown	RAL 9003-8019			
PO00205	White-red	RAL 9003-3020			
PO00209	White-black	RAL 9003-9004			
PO00212	White-anthracite	RAL 9003-NCS S 7500N			
PO00213	White-ivory	RAL 9003-NCS S 2005-Y20R			
PO00214	White-turtledove grey	RAL 9003-NCS S 4005-Y20R			
PO00215	White-yellow	RAL 9003-NCS S 1050-G90Y			
PO00216	White-rosé	RAL 9003-NCS S 3020-Y80R			
PO00217	White-petrol	RAL 9003-NCS S 4010-B50G			
PO00218	White-green	RAL 9003-PANTONE 390 U			
Metals					
CRO	Chrome finish steel				
LU1	Shiny aluminium/steel		X		X
S03	Brushed stainless steel				
V12	White powdercoated	RAL 9003	X	X	
V13	Green powdercoated	PANTONE 390 U		X	
V14	Space grey				X
V15	Anthracite grey				X
V16	Copper				X
V22	White powdercoated	RAL 9010		X	
V24	White powdercoated	NCS S 0500-N		X	
V25	Black powdercoated	NCS S 8500-N		X	
V34	Moka White powdercoated	RAL 8019	X	X	
V39	Black powdercoated	RAL 9005	X	X	
V44	Noir sable powdercoated	RAL 2100		X	
V48	Red powdercoated	RAL 2002	X	X	
V53	Ivory powdercoated	NCS S 2005-Y20R		X	
V54	Turtledove grey powdercoated	NCS S 4005-Y20R		X	
V55	Yellow powdercoated	NCS S 1050-G90Y		X	
V56	Rosé powdercoated	NCS S 3020-Y80R		X	
V57	Petrol powdercoated	NCS S 4010-B50G		X	
V59	Blue	NCS S 8010-R70B		X	

24% rabatt ska dras av på angivna priser

Materials	Description	Colour	Glossy	Matt	Semi-gloss
V60	Green	NCS S 7020-G10Y		X	
V61	Red earth	NCS S 5040-Y70R		X	
V62	Yellow ochre	NCS S 5040-Y10R		X	
V63	Rust	NCS S 4040-Y70R		X	
V64	Bark brown	NCS S 7005-Y80R		X	
V65	Olive green	NCS S 6010-G90Y		X	
V66	Dark blue	NCS S 8010-R90B		X	
Compact HPL					
H02	White	NCS S 0502-G50Y		X	
H03	Black	NCS S 9000-N		X	
H04	Grey				
Melamine					
N01	White	NCS S 0502-G50Y		X	
N02	Black	NCS S 9000-N		X	
MDF					
M02	White				
M04	Black				
M08	Moss green	NCS S 5020-G50Y			
M09	Red clay	NCS S 4030-Y60R			
MDF + laminate					
M34	Dark brown + White	RAL 8019-RAL 9003			
M39	Black + White	RAL 9004-RAL 9003			
M48	Red + White	RAL 2002-RAL 9003			
M53	Ivory + White	NCS S2005-Y20R-RAL 9003			
Laminati					
LM00022	Effect natural oak				
LM13	Effect black oak				

24% rabatt ska dras av på angivna priser

Materials	Description	Colour	Glossy	Matt	Semi-gloss
Fenix					
F01	White				
F02	Black				
F06	Bromo grey				
Porcelain stoneware					
C10	Clear				
C11	Dark				
Venetian Terrazzo					
B10	Clear				
B11	Dark				
Wood					
L14	Walnut				
L15	Maple				
L21	Wengé oak				
L22	Natural oak				
L0001	White oak				
L0006	Black oak				
L0009	Natural birch effect				
L0010	Stained birch effect, oak				
L0011	Stained birch effect, walnut				
L0012	Stained birch effect, white				
L0013	Stained birch effect, black				
L0020	Bleached oak				
L0021	Wengé oak				
L0022	Natural oak				
L0023	Teak effect				
LG00024	Natural oak				
LG00025	Wengé oak				
LG00026	Walnut				

24% rabatt ska dras av på angivna priser

Materials	Description	Colour	Glossy	Matt	Semi-gloss
Marble					
B01					
Glass					
V02					

NCS / RAL / PANTONE codes refer to the masters used for the colours. Surface finishes may cause slight variations in appearance relative to the indicated references.

24% rabatt ska dras av på angivna priser

Care instructions

Fabrics:

It is important that fabrics are cleaned regularly in order to keep them looking their best and extend their life. Powder and dirt can cause wear and tear on fabrics and as such we advise that you clean them using a low-pressure vacuum cleaner, preferably once a week.

Non-greasy stains can be removed by delicately dabbing them with a clean cloth that won't leave any lint or a sponge that has been soaked in clean, warm water then thoroughly squeezed out. If necessary, you can then soak with soapy water or water with liquid washing up detergent added (see formulas). Once this is done, soak the surface with clean, tepid water.

For greasy stains, use a dry stain remover. Ensure that you comply with the manufacturer's instructions as closely as possible. If you have any doubts, test the cleaning product on a discreet area in order to check its effect. Wait for at least 24 hours to see if any problems arise.

Formulas: The soapy solution consists of ¼ deciliter soap flakes per liter of hot water, which must then be cooled before use. The solution with dishwashing liquid is made up of max 1 teaspoon of detergent per every liter of water. If you use concentrated products, pour only a few drops into each liter of product.

Coated fabrics:

Regularly dust using a microfibre cloth. In the event of stains, clean using a cloth that has been dampened using tepid water or water with some neutral soap in it. Do not use abrasive products, ethyl alcohol and solvent-based detergents. If you have any doubts, test the cleaning product on a discreet area in order to check its effect. Wait for at least 24 hours to see if any problems arise.

Structural mesh in knitted fabric:

Made to Arper's technical specifications with post-consumption recycled polyester yarns, the knitted fabric mesh is soft and comfortable. The particular structure makes it self-draining and breathable, this ensures rapid passage of the water and makes it quick drying. It has excellent resistance to weathering, humidity and temperature changes, also thanks to the addition of anti-UV stabilisers that prevent and slow down natural ageing without the addition of substances dangerous to the environment or to health. Maintenance: It is important to regularly clean the fabric in order to maintain its appearance in the best conditions and to extend its life. Dust and dirt wear out the fabric, so it is recommended to clean it with low suction vacuum cleaners, preferably once a week. Non-grease stains are eliminated by gently dabbing them with a clean cloth that leaves no residue or a sponge immersed in clean hot water and then well squeezed. If necessary, wash by dipping the cloth used for cleaning in soapy water or water with the addition of liquid dishwashing detergent (see formulas). Then dab

the surface with clean warm water, letting it dry completely.

For grease stains, it is possible to use dry stain removers, scrupulously following the manufacturer's instructions.

Do not use hot steam, do not dry with electrical appliances with temperatures above 50°C. Do not use abrasive substances or chemical solvents.

In case of doubt, test the cleaning product on a part hidden from view to verify the result, waiting at least 24 hours for any problems to arise.

Formulas: The soapy solution consists of 1/4 dl of soap flakes for each litre of hot water, which then needs to be cooled before use. The solution with liquid dishwashing detergent consists of up to 1 teaspoon of detergent per litre of water. If you use concentrated products, pour only a few drops into each litre of product.

Leather, hard leather:

Take care not to place products in direct sunlight as this can alter the colour of these materials. Avoid exposing the materials to heat sources.

Regularly dust using a soft, dry cloth. Any stains need to be removed as quickly as possible to prevent them from soaking in deeply. Use absorbent paper or a cloth to absorb them straight away. For cleaning, use specific, high-quality leather cleaning products and comply with the manufacturer's instructions as closely as possible.

If you have any doubts, test the cleaning product on a discreet area in order to check its effect. Wait for at least 24 hours to see if any problems arise. Alternatively, use a cloth that has been dampened with some water and well-diluted neutral soap. Do not rub. Instead, delicately dab the stain working from the edge into the centre, then dry immediately after treatment.

Wood:

Dust and common domestic stains can be removed using a solution made from water and well-diluted neutral soap. Under no circumstances should you use commercial stain removers for cleaning. In order to avoid scratching the products, use a soft cloth and clean using circular movements. Do not use solvents or abrasive products. Always dry surfaces using a dry cloth. If you have any doubts, test the cleaning product on a discreet area in order to check its effect. Wait for at least 24 hours to see if any problems arise.

Wood for outdoor use:

Wood is a natural material suitable for outdoor use. For a sustainable approach, Arper selects only essences from Europe within an FSC certified chain of custody. The use of water-based paints, safe for health and the environment, guarantees a high level of protection and durability for outdoor use, with a reduced

24% rabatt ska dras av på angivna priser

Care instructions

environmental impact.

Maintenance: Dust and the most common stains can be removed using a well-diluted solution of water and neutral soap. It is absolutely necessary not to use commercial stain removers for cleaning. To avoid scratching, use a soft cloth and clean with gentle, circular movements (especially the opaque finishes, if subjected to action that is too aggressive, may develop shiny halos in spots). Do not use waxes for furniture or floors, solvents or abrasive products. Always dry the surfaces with a dry cloth. Do not use the pressure washer or high-pressure water, which may damage the surface of the wood. In case of doubt, test the cleaning solution on a part hidden from view to verify the result, waiting at least 24 hours for any problems to arise. Immediately remove any liquids spilled on the surface of the wood, avoid the accumulation of water or other liquids that could damage the product.

Wood can have impurities and imperfections, which fall within accepted quality standards, and should be considered as distinctive features that attest to its natural beauty. Periodic and correct maintenance extends the life of the product.

Plastic Materials:

Regularly plastic surfaces dust using a microfibre cloth. Dust and common domestic stains can be removed using a cloth or sponge that has been dampened in tepid water or water with some well-diluted neutral detergent in it.

Do not use commercial stain removers or aggressive products for cleaning. In order to avoid scratching the products, use a soft cloth and clean using circular movements. Under no circumstances should you use solvent-based detergents or abrasive products. If you have any doubts, test the cleaning product on a discreet area in order to check its effect. Wait for at least 24 hours to see if any problems arise.

Chrome-plated, anodised or painted metal surfaces:

Clean using specific products such as regular detergents for domestic surfaces diluted in tepid water, provided they are not abrasive and do not contain acid or bleach. Avoid using sponges and scourers made from synthetic fibre or metal as these could permanently mark surfaces. After cleaning, rinse products carefully to prevent traces of detergent from reacting with the surface finish to avoid dulling or oxidation. After cleaning, dry with a shammy cloth. The use of polish on chrome-plated or painted surfaces is not recommended. These products should always be used with caution and only by experts as their abrasive qualities could irreparably damage surfaces. If you have any doubts, test the cleaning product on a discreet area in order to check its effect. Wait for at least 24 hours to see if any problems arise.

Stainless steel:

Clean on a regular basis (every 15-20 days) using a soft damp cloth or common products specific for stainless steel.

Table Tops:

Clean and remove any substance that accidentally comes into contact with the surface as quickly as possible using a damp cloth or microfibre cloth and some neutral detergent diluted in tepid water. Always dry after cleaning. Aggressive detergents containing bleach or abrasive detergents (such as bathroom cream cleaner) must never be used. Take care not to rub too hard in order to avoid scratching the surface. Avoid using sponges or scourers made from synthetic fibres or metal.

If you have any doubts, test the cleaning product on a discreet area in order to check its effect. Wait for at least 24 hours to see if any problems arise.

Glass surfaces

The tempered glass used by Arper ensures high levels of safety. In the event of a breakage, the glass smashes into tiny, rounded fragments which will not cause a cut. In any case, you should avoid hitting the glass with hard or sharp objects and the glass should not be exposed to extreme shifts in temperature (i.e. do not place very hot or cold items on it).

Regularly dust glass using a microfibre cloth. Clean using specific products or neutral soap applied using a soft, clean cloth. Do not use powered detergents or abrasive detergents that could scratch the glass, causing irrevocable damage to the surface. If you have any doubts, test the cleaning product on a discreet area in order to check its effect. Wait for at least 24 hours to see if any problems arise.

Marble and Venetian Terrazzo surfaces:

Clean and remove any substance that accidentally comes into contact with the surface as quickly as possible using a damp cloth or microfibre cloth and some tepid water or a specialist detergent. Always dry immediately after cleaning. Take care not to rub too hard in order to avoid scratching the marble. If you have any doubts, test the cleaning product on a discreet area in order to check its effect. Wait for at least 24 hours to see if any problems arise.

Marble is a calcareous, porous material that is susceptible to reactions with acidic substances. Marble can absorb fatty or oily substances and colourants. These can soak into the material and stain the surface. During use, you are advised against using objects that can scratch or cause abrasions to the surface, such as acidic products (Coca Cola, vinegar, acidic detergents) and colourants (wine, coffee, fruit, sugary liquid, tomato sauce, very hard water etc.).

24% rabatt ska dras av på angivna priser

Care instructions

Indications for use & maintenance of “outdoor” products:

Arper guarantees, through laboratory tests, the strength and durability of its products. It should be noted, however, that any material exposed to atmospheric agents and the elements, even if treated specifically for outdoor use, will undergo a gradual deterioration over time, the extent of which is closely related to the geographical position, the evolution of climatic phenomena, the more or less marked presence of humidity, salinity (poolside, marine environments).

Use and maintenance are conditions that determine the actual yield and maintenance in good condition of the product over time. It is therefore recommended to avoid critical external conditions such as prolonged and direct exposure to sunlight, pouring rain and aggressive environments such as proximity to the seaside or where the sea breeze can bring high levels of moisture with marine salinity or abrasive sands. Do not place wooden products on lawns or uneven surfaces, where any stagnation of water may damage the parts in contact. In any case, never let water or other liquids stagnate on the product. In the vicinity of plants or trees, remove any leaves, flowers or organic substances that could rest on the surfaces of the product, to prevent that their deterioration stains the paints or fabrics. In case of exposure to rain, as soon as possible, remove the pillows (if any) from the chair and let them dry separately to facilitate drying and drainage of the water. Periodic cleaning is recommended, following the recommended indications for the different materials. For short periods when the product is not in use, it is recommended to cover it with the protective cover. In case of prolonged non-use or during the winter period, it is recommended to clean the product, allow it to dry well, and store it in a well-aerated indoor place, protected from the elements. The pillows (if any) must be removed from the chair, cleaned and left to dry well, and finally, stored in a well-aerated indoor place, protected from the elements.

24% rabatt ska dras av på angivna priser

24% rabatt ska dras av på angivna priser

I colori visualizzati sono puramente indicativi e possono variare rispetto alla realtà. Rivolgersi ad Arper o al proprio rivenditore di fiducia per ricevere un campione colore o per maggiori informazioni.

Arper SPA si riserva di apportare modifiche e/o migliorie di carattere tecnico ed estetico ai propri modelli e prodotti in qualsiasi momento e senza preavviso.

Per maggiori informazioni visitate il sito arper.com

Colours shown are used for reference only and may look different in reality. Please contact Arper or your retailer to receive a colour sample or more information.

Arper SPA reserves the right to make modifications and improvements of a technical or aesthetic nature to the products at any time without notice.

For further information, please visit arper.com

Bei den angezeigten Farben handelt es sich um reine Farbbeispiele, die von der Realität abweichen können.

Für Farbmuster und nähere Informationen wenden Sie sich bitte an Arper oder an den Händler Ihres Vertrauens.

Arper SPA behält sich das Recht vor, jederzeit und ohne Vorankündigung Veränderungen und Verbesserungen technischen und ästhetischen Charakters an seinen Produkten vorzunehmen.

Für weitere Informationen besuchen Sie bitte unsere Webseite arper.com

La reproduction photographique des couleurs n'est que purement indicative et peut être différente de la réalité. S'adresser à Arper ou à votre revendeur de confiance pour recevoir un échantillon de couleur ou pour de plus amples informations.

Arper SPA se réserve le droit d'apporter des modifications et/ou des améliorations d'ordre technique et esthétique à ses produits, et ceci à tout moment et sans préavis.

Pour plus d'informations, rendez-vous sur le site arper.com

Los colores visualizados son meramente indicativos y pueden diferir de la realidad. Para recibir una muestra del color o para más información, contactar a Arper o a su distribuidor de zona. Arper SPA se reserva el derecho de realizar cambios y/o mejoras técnicas y estéticas en sus productos en cualquier momento y sin previo aviso.

Para más información, visite arper.com

24% rabatt ska dras av på angivna priser

24% rabatt ska dras av på angivna priser

Italy

Monastier (TV) — Headquarters and showroom
Arper SPA
Via Lombardia 16
31050 Monastier di Treviso (TV)
T +39 0422 7918
F +39 0422 791800
info@arper.com
www.arper.com

Commerciale Italia
T +39 0422 791905
F +39 0422 791900
commerciale@arper.com

Export Office
sales@arper.com

Milan — Showroom
Via Pantano 30
20122 Milan
T +39 02 89093865
milano@arper.com

EUROPE

UK

London — Subsidiary and showroom
Arper UK LTD
11 Clerkenwell Road
London EC1M 5PA
T +44 (0) 20 7253 0009
london@arper.com

Germany

Cologne — Showroom
Design Post Köln
Deutz-Mülheimer-Str. 22a
50679 Köln
T +49 221 690 650
info@designpost.de

Fruchtof München — Meeting Hub
2. Innenhof, 2. Etage
Gotzinger Straße 52b
D-81371 München
T +49 171 1080976
muenchen@arper.com

Norway

Oslo — Showroom
Drammensveien 130
0277 Oslo
T +47 908 202226
norway@arper.com

Sweden

Stockholm — Branch
T +46 705 101216
sweden@arper.com

The Netherlands

Amsterdam — Showroom
Design Post
Cruquiusweg 111-L
1019 AG Amsterdam
T +31 (0)20 705 1555
showroom@beltane.nl

AMERICA

USA

New York — Subsidiary and showroom
Arper USA Inc.
476 Broadway, Suite 2F
NY 10013 New York
T +1 (212) 647 8900
infousa@arper.com

Chicago — Showroom
The Merchandise Mart
Space#346 - 3rd Floor
Chicago
T +1 (336) 434 2366
infousa@arper.com

High Point, North Carolina — Production
and logistics site
660 Southwest St
High Point, NC 27260
T +1 (336) 434 2370
F +1 (212) 647 8912
infousa@arper.com

Los Angeles — Showroom
550 South Hope St., Suite 275
90071 Los Angeles
T +1 (336) 434 2382
infousa@arper.com

Mexico

Mexico City — Subsidiary and showroom
Culiacan 123, Piso 9
Col. Hipodromo Condesa
Delegation Cuauhtémoc
06170 - Ciudad de México
Mexico
T +52 1 62714417
T +52 1 62714419
infolatam@arper.com

ASIA

Japan

Arper Japan K.K. — Subsidiary and showroom
HT Jingu Gaien Bldg.8F
Minato-ku Kita-Aoyama 2-7-22
Tokyo 107-0061
T +81 3 5775 0008
F +81 3 5775 0009
carejpn@arper.com

China

Shanghai — Subsidiary
爱尔派 (上海) 家具设计有限公司
Shanghai - China
china@arper.com

Singapore

Singapore — Branch
c/o 3 Lim Teck Kim Road, #01-01 Genting Centre
088934 Singapore
singapore@arper.com

UAE

Arper Middle East — Subsidiary and showroom
U-Bora Towers - Unit 1901
Business Bay
Dubai
T +971 529255633
infome@arper.com

24% rabatt ska dras av på angivna priser

arper

24% rabatt ska dras av på angivna priser

Stockholm
Gävle

Göteborg
Hedemora

Malmö
Edsbyn

Uppsala
Jönköping

Helsingborg
Sundsvall

Umeå

SENAB
space for big ideas