

# 24% rabatt ska dras av på angivna priser



## Statligt ramavtal - Möbler och inredning

---

Delområde: Arbetsplats och förvaring

Dnr 23.3.-8004-18:056

Produktlista nr: 4

**HAY**

**2022**



# 24% rabatt ska dras av på angivna priser

## Kontaktuppgifter

---

### Lokala kontor och utställningar:

#### Stockholm

Regeringsgatan 66  
103 88 Stockholm

Peter Almgren  
076-533 50 43  
peter.almgren@senab.com

#### Göteborg

Fiskhamngatan 6C  
414 58 Göteborg

Martin Oskarsson  
076-533 50 10  
martin.oskarsson@senab.com

#### Malmö

Fersens väg 3  
211 42 Malmö

Niclas Mattsson  
070-372 23 05  
niclas.mattsson@senab.com

#### Uppsala

St:Olofsgatan 10B  
753 12 Uppsala

Stina Lawyer  
076-533 50 58  
stina.lawyer@senab.com

#### Helsingborg

Järnvägsgatan 57  
252 18 Helsingborg

Bosse Weberg  
076-533 53 41  
bosse.weberg@senab.com

#### Umeå

Storgatan 41  
903 25 Umeå

Frida Bergström  
072-050 95 84  
frida.bergstrom@senab.com

#### Luleå

Timmermansgatan 4  
972 33 Luleå

Helena Öberg  
076-502 02 05  
helena.oberg@senab.com

#### Gävle

Nygatan 28  
803 11 Gävle

Cecilia Sjöblom  
076-501 10 93  
cecilia.sjoblom@senab.com

#### Hedemora

Kålgårdsvägen 12  
776 93 Hedemora

Michael Andersson  
076-501 10 95  
michael.andersson@senab.com

#### Edsbyn

Karls väg 2  
828 25 Edsbyn

Ronny Fagerhov  
070-224 67 44  
ronny.fagerhov@senab.com

#### Jönköping

Västra Storgatan 6  
553 15 Jönköping

Pia Heldt  
076-533 51 57  
pia.heldt@senab.com

#### Norrköping

Sankt Persgatan 19  
601 86 Norrköping

Jan Magnusson  
076-945 19 36  
jan.magnusson@senab.com

#### Sundsvall

Thulegatan 25  
852 36 Sundsvall

Jonas Westerlund  
076-502 02 04  
jonas.westerlund@senab.com

24% rabatt ska dras av på angivna priser



# HAY NEW ORDER PRICELIST

SWEDEN JANUARY 2022

REC. RETAIL PRICES IN SEK INCL. VAT

Subject to increases in prices and printing errors

# 24% rabatt ska dras av på angivna priser

## CONTENT

NEW ORDER OVERVIEW .....	4	STEEL SLIDING DOOR   100   150 .....	31
SHELF TOP   34   100   150 .....	17	STEEL SLIDING DOOR   100 LEFT .....	31
SHELF MIDDLE   34   100   150 .....	17	STEEL SLIDING DOOR PREPARED FOR LOCK   100   150 .....	32
SHELF BOTTOM   34   100   150 .....	17	STEEL SLIDING DOOR PREPARED FOR LOCK   100 LEFT .....	32
TRAY TOP   100   150 .....	18	STEEL SLIDING DOOR DOUBLE HEIGHT   100 .....	33
SINGLE PROFILE   SET OF 4 .....	19	STEEL SLIDING DOOR DOUBLE HEIGHT   100 LEFT .....	33
DOUBLE PROFILE   SET OF 2 .....	19	STEEL SLIDING DOOR PREPARED FOR LOCK DOUBLE HEIGHT   100 .....	33
CORNER PROFILE   SET OF 1 + 1 .....	19	STEEL SLIDING DOOR PREPARED FOR LOCK DOUBLE HEIGHT   100 LEFT .....	34
BENCHTOP   34   100   150 .....	20	HIGH DRAWER INCL. MOUNTING SET   34   SET OF 1 OR DOUBLE HEIGHT   SET OF 2 .....	35
STEEL SIDE PANEL   34 .....		HIGH DRAWER INCL. MOUNTING SET 100   SET OF 1 OR DOUBLE HEIGHT   SET OF 2 .....	35
STEEL SIDE PANEL DOUBLE HEIGHT 34 .....	23	DRAWER INCL. MOUNTING SET 34   SET OF 2 OR DOUBLE HEIGHT   SET OF 4 .....	36
STEEL SIDE PANEL DOUBLE HEIGHT FOR ADJUSTABLE SHELF   34 .....	23	DRAWER INCL. MOUNTING SET 100   SET OF 2 OR DOUBLE HEIGHT   SET OF 4 .....	36
STEEL SHELF FOR ADJUSTABLE PANELS   100 .....	23	MIDDLE BAR FOR DRAWER   34   100 .....	36
PINS FOR ADJUSTABLE SHELF   SET OF 4 .....	23	LOCK BAR DRAWER PREPARED FOR LOCK 34   100 .....	37
		EXTRA LOCK CYLINDER .....	37
STEEL BACK PANEL   100   150 .....	24	EXTRA KEY FOR LOCK CYLINDER .....	37
STEEL BACK PANEL DOUBLE HEIGHT   100 .....	24	MASTER KEY .....	38
STEEL WALL BACK PANEL   100   150 .....	24	EXCHANGE KEY FOR LOCK CYLINDER .....	38
STEEL WALL BACK PANEL DOUBLE HEIGHT   100 .....	24	WALL BRACKET SHELF   SET OF 2 WALL BRACKET FOR DOUBLE HEIGHT SHELF   SET OF 2 .....	39
STEEL TABLE PANEL   34 .....		WALL SAFETY BRACKETS FOR SHELVING SYSTEM   SET OF 2 .....	39
STEEL TABLE PANEL DOUBLE HEIGHT   34 .....	25	FLOOR SAFETY BRACKETS FOR SHELVING SYSTEM   SET OF 2 .....	39
STEEL TABLE PANEL DOUBLE HEIGHT FOR ADJUSTABLE SHELF   34 .....	25	REPAIR KIT .....	40
STEEL TABLE BACK PANEL   100   150 .....	25	WHEELS   SET OF 4 .....	40
STEEL TABLE BACK PANEL DOUBLE HEIGHT   100 .....	26	SHELF BOOK DIVIDER   LEFT OR RIGHT .....	40
STEEL PERFORATED BACK PANEL   100   150 .....	26	TROLLEY A   1 DRAWER & TRAY TOP .....	41
STEEL PERFORATED BACK PANEL DOUBLE HEIGHT   100 .....	26	TROLLEY B   3 DRAWER & TRAY TOP .....	41
MOUNTING ADAPTER TRAY .....	27	TABLE   4 LEGS .....	42
BACK PANEL FASTENER ADAPTER TRAY .....	27	TABLE   4 LEGS .....	42
TEXTILE PANEL   34   100   150 .....	28	TABLE INCL. SINGLE PLUG & PLAY   4 LEGS .....	43
INSIDE TEXTILE PANEL   34   100   150 .....	28	TABLE INCL. CABLE MANAGEMENT EDGE   4 LEGS .....	43
TEXTILE SIDE PANEL DOUBLE HEIGHT   34 .....	29	TABLE INCL. PLUG & PLAY CABLE MANAGEMENT EDGE   4 LEGS .....	44
INSIDE TEXTILE SIDE PANEL DOUBLE HEIGHT   34 .....	29	TABLE INCL. CABLE MANAGEMENT EDGE 34 CM   4 LEGS .....	44
TEXTILE BACK PANEL DOUBLE HEIGHT   100 .....	30	TABLE INCL. PLUG & PLAY CABLE MANAGEMENT EDGE 34 CM   4 LEGS ..	45
INSIDE TEXTILE BACK PANEL DOUBLE HEIGHT   100 .....	30		

# 24% rabatt ska dras av på angivna priser

TABLE INCL. CABLE MANAGEMENT EDGE 34 CM   PREPARED FOR TOP TRAY DIVIDER   4 LEGS.....	45	COVER FOR CABLE MANAGEMENT W. PEN HOLDER   MODULE SIZE 50 CM .....	63
TABLE INCL. PLUG & PLAY CABLE MANAGEMENT EDGE 34 CM   PREPARED FOR TOP TRAY DIVIDER   4 LEGS.....	46	COVER FOR CABLE MANAGEMENT   MODULE SIZE 25 CM.....	63
TABLE INCL. CABLE MANAGEMENT   PREPARED FOR TOP TRAY DIVIDER AND TABLE SCREENS EDGE   4 LEGS .....	46	COVER FOR CABLE MANAGEMENT   MODULE SIZE 50 CM.....	63
TABLE INCL. PLUG & PLAY CABLE MANAGEMENT   PREPARED FOR TOP TRAY DIVIDER AND TABLE SCREENS EDGE   4 LEGS .....	47	COVER FOR PLUG AND PLAY   DOUBLE P&P CABLE MANAGEMENT   MODULE SIZE 25 CM.....	63
TABLE INCL. CABLE MANAGEMENT CENTER OR PREPARED FOR TABLE SCREENS   4 LEGS.....	47	COVER FOR PLUG AND PLAY   DOUBLE P&P CABLE MANAGEMENT   MODULE SIZE 50 CM.....	64
TABLE INCL. CABLE MANAGEMENT CENTER OR PREPARED FOR TABLE SCREENS   4 LEGS.....	48	FLIP COVER FOR PLUG AND PLAY   DOUBLE P&P CABLE MANAGEMENT   MODULE SIZE 50 CM   MIDDLE.....	64
TABLE INCL. PLUG & PLAY CABLE MANAGEMENT CENTER OR PREPARED FOR TABLE SCREENS   4 LEGS.....	48	NO COMBINATION 101.....	65
TABLE INCL. PLUG & PLAY CABLE MANAGEMENT CENTER OR PREPARED FOR TABLE SCREENS   4 LEGS.....	49	NO COMBINATION 102 .....	65
TABLE INCL. DOUBLE PLUG & PLAY CABLE MANAGEMENT CENTER IN COMBINATION WITH TABLE SCREENS   4 LEGS .....	49	NO COMBINATION 103 .....	65
TABLE SCREEN EDGE   58   73.....	50	NO BENCH COMBINATION 100 .....	66
TABLE SCREEN MIDDLE   100   150   200.....	50	NO BENCH COMBINATION 150 .....	66
TABLE LEGS .....	51	NO COMBINATION 201 .....	67
DOUBLE TABLE LEGS .....	51	NO COMBINATION 202.....	67
TABLE CONNECTORS .....	52	NO COMBINATION 203.....	68
CABLE CLIP   SET OF 2.....	52	NO COMBINATION 204.....	68
CABLE GUIDE FOR TABLE LEG   H74 .....	52	NO COMBINATION 205.....	69
HIGH TABLE HT-5   H90 CM .....	53	NO COMBINATION 301 .....	69
HIGH TABLE HT-12   H90 CM .....	53	NO COMBINATION 303.....	70
HIGH TABLE HT-6   H90 CM .....	54	NO COMBINATION 401 .....	70
HIGH TABLE HT-3   H90 CM .....	54	NO COMBINATION 501 .....	71
HIGH TABLE HT-8   H90 CM .....	55	NO COMBINATION 502.....	71
HIGH TABLE HT-5   H105 CM .....	55	NO COMBINATION 701.....	72
HIGH TABLE HT-12   H105 CM.....	56	NO COMBINATION 702 .....	72
HIGH TABLE HT-6   H105 CM .....	56	NO TABLE COMBINATION 401.....	73
HIGH TABLE HT-3   H105 CM .....	57	COLOURS & MATERIALS.....	74
HIGH TABLE HT-8   H105 CM .....	58	GENERAL TERMS OF SALE AND DELIVERY.....	75
CABLE TRAY   35.....	59	FABRIC & LEATHER UPHOLSTERY .....	75
CABLE TRAY FOR STEP MODULE   35 .....	59	CARE & MAINTENANCE.....	75
STEP MODULES FOR CABLE MANAGEMENT .....	60	FSC™ CERTIFICATION.....	75
STEP MODULES FOR CABLE MANAGEMENT .....	61	ECOLABELS.....	75
STEP MODULE EXTENSION CABLE.....	62	SUSTAINABILITY .....	75
STEP MODULES SUPPLY CABLES.....	62	DOWNLOADS .....	75

# 24% rabatt ska dras av på angivna priser

## NEW ORDER OVERVIEW

### SHELVES

Shelf, corner, top,  
middle, and bottom  
34|100|150

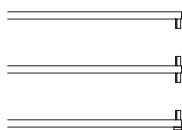

### TRAY

Tray top  
100|150

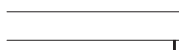

### BENCHTOPS

Benchtop 34



Benchtop 100

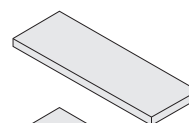

Benchtop 150

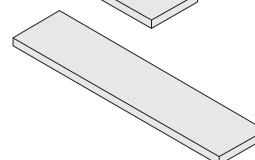

### PROFILES

Single profile  
Set of 4  
H33 cm



Double profile  
Set of 2  
H33 cm



Corner profile  
Set of 1 x triple  
1 x single  
H33 cm



Single profile  
for double height  
Set of 4  
H68 cm



Double profile  
for double height  
Set of 2  
H68 cm



Corner profile  
for double height  
Set of 1 x triple  
1 x single  
H68 cm

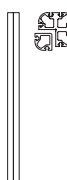



# 24% rabatt ska dras av på angivna priser

## STEEL PANELS

Side panel 34



Side panel double height 34

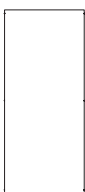

Side panel double height for adjustable shelf 34

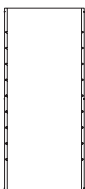

Back panel 100



Back panel Double height 100



Back panel 150



## STEEL TABLE PANELS

Table panel 34



Table panel double height 34

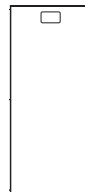

Table panel double height for adjustable shelf 34

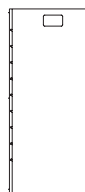

Table back panel 100

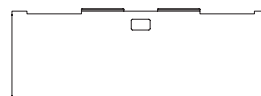

Table back panel double height 100

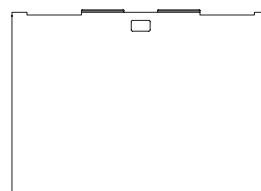
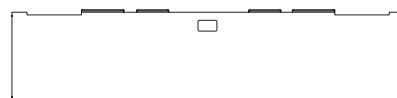

Table back panel 150



## STEEL SHELF FOR ADJUSTABLE SIDE PANELS

Steel shelf 100



## STEEL WALL BACK PANELS

Wall Panel 100



Wall Panel 150



Wall back panel double height 100



## PINS FOR ADJUSTABLE SHELF

Set of 4



# 24% rabatt ska dras av på angivna priser

## PERFORATED STEEL PANELS

Perforated  
back panel 100

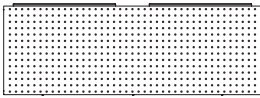

Perforated  
back panel  
double height 100

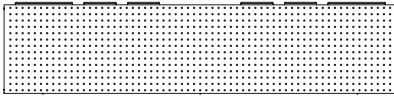
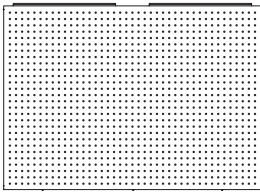

## TEXTILE PANELS

Textile  
side panel 34



Textile  
side panel  
double height 34



Textile  
back panel 100



Textile  
panel back panel double  
height 100



Textile  
back panel 150

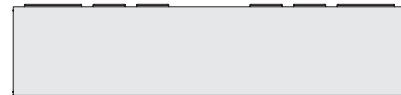

## STEEL PANEL ACCESSORIES

Mounting adapter tray

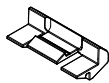

Back panel  
fastener adapter tray

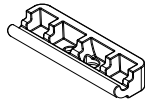

## STEEL DOORS

Sliding door  
100

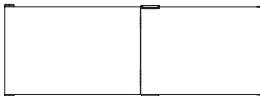

Sliding door  
100  
prepared for lock

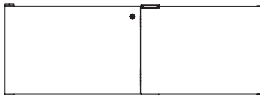

Sliding door  
150



Sliding door  
150  
prepared for lock

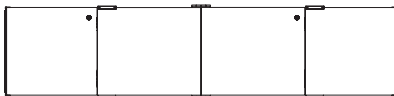

Sliding door  
double height  
100

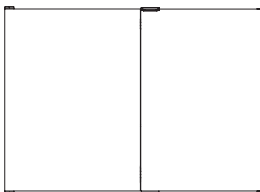

Sliding door  
double height  
100  
prepared for lock

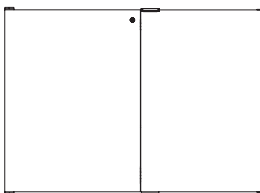

Sliding door  
100 left



Sliding door  
100 left  
prepared for lock



Sliding door  
double height  
100 left

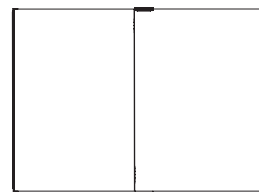

Sliding door  
double height  
100 left  
prepared for lock

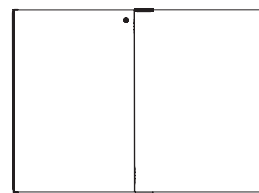



# 24% rabatt ska dras av på angivna priser

## STEEL DRAWERS

High Drawer 34  
Set of 1

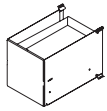

High Drawer 34  
Double height  
Set of 2

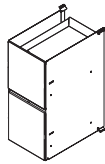

High Drawer 100  
Set of 1

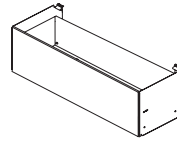

High Drawer 100  
Double height  
Set of 2

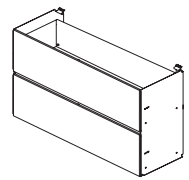

Drawer 34  
Set of 2

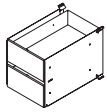

Drawer 34  
Double height  
Set of 4

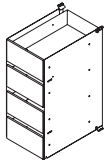

Drawer 100  
Set of 2

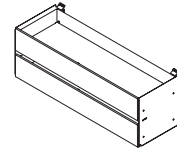

Drawer 100  
Double height  
Set of 4

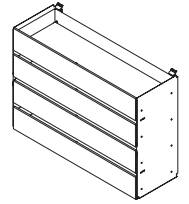

## MIDDLE BARS FOR DRAWERS

Lock bar  
for drawer

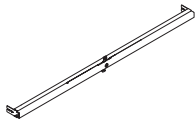

Middle bar  
for drawer

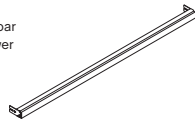

## LOCK SYSTEM

Extra lock cylinder



Master key



Extra Key for lock cylinder



Exchange key



## SAFETY BRACKETS

Wall safety brackets  
Set of 2

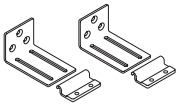

Floor safety brackets  
Set of 2

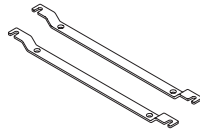

## WALL BRACKETS

Wall bracket shelf  
Set of 2

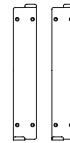

Wall bracket for double height shelf  
Set of 2



## ACCESSORIES

Repair Kit



Wheels  
Set of 4

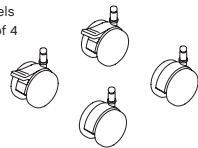

Shelf Book divider,  
left or right

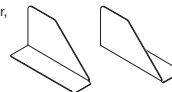

## TROLLEYS

Trolley A  
1 drawer and tray top  
incl. lock

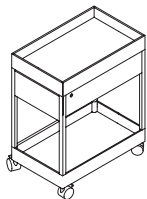

Trolley B  
3 drawers & tray top  
incl. lock

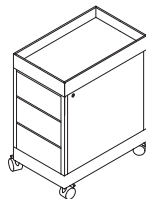

# 24% rabatt ska dras av på angivna priser

## TABLE LEGS

New order tables can be connected to the shelves with table connectors. The tables are available with 1, 2, 3 or 4 legs

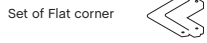
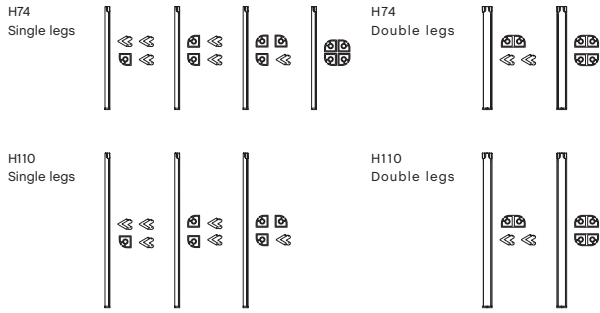

## TABLE CONNECTORS

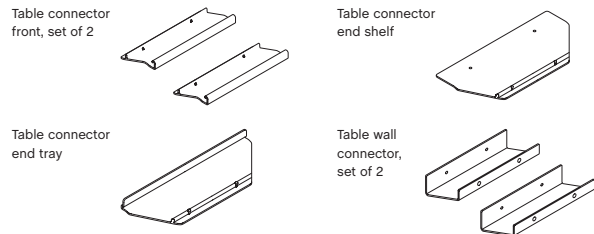

## CABLE MANAGEMENT ACCESSORIES

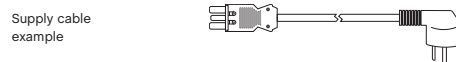
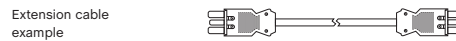
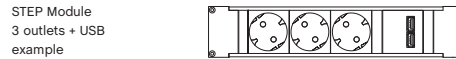
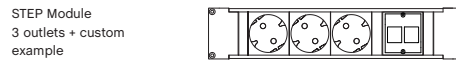
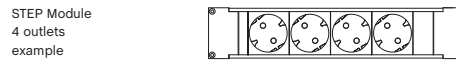
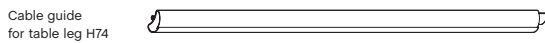
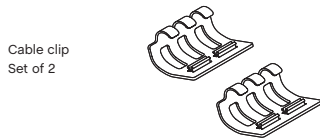
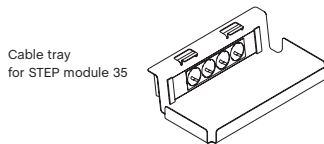
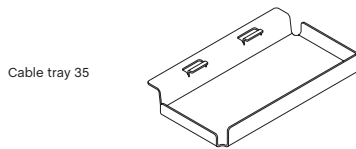

## COVERS

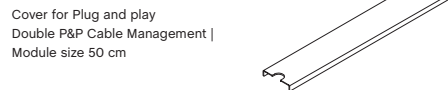
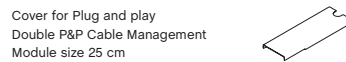
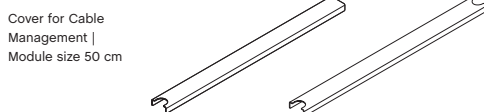
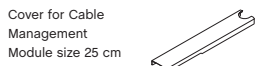
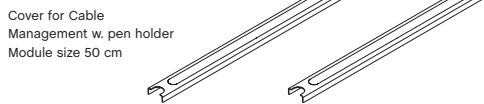

# 24% rabatt ska dras av på angivna priser

## CABLE MANAGEMENT AND TABLE SCREEN OVERVIEW

Standard cable management

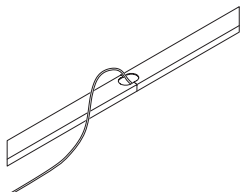

Plug & play cable management

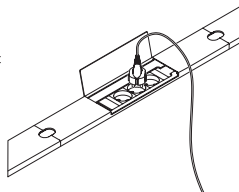

Single plug & play cable management

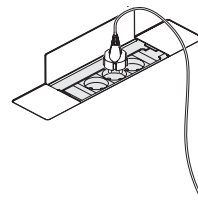

Double plug & play incl. middle screen

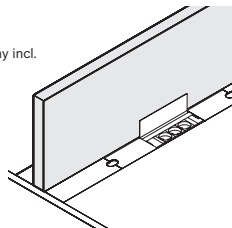

Tray divider with standard cable management

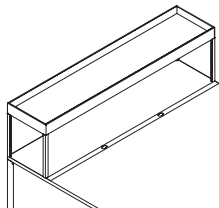

Tray divider with plug & play cable management

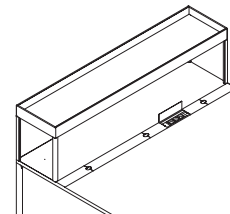

Middle table screen

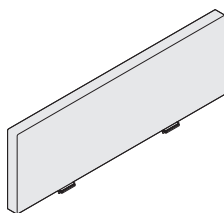

Edge table screen

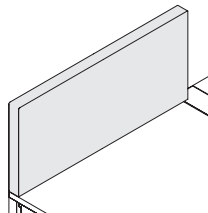

## TABLE SCREENS

Table screen edge 58

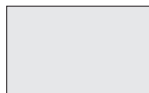

Table screen middle 150



Table screen edge 73



Table screen middle 200

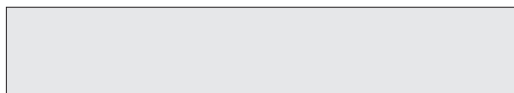
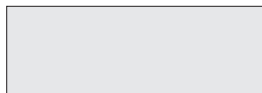

Table screen middle 100



# 24% rabatt ska dras av på angivna priser

## TABLE OVERVIEW

100 x 50

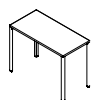

1A

100 x 100

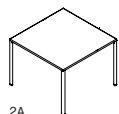

2A

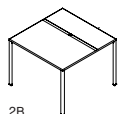

2B

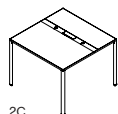

2C

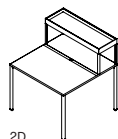

2D

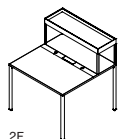

2E

100 x 150

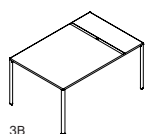

3B

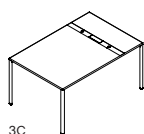

3C

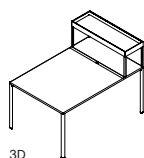

3D

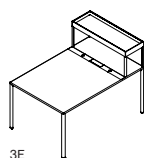

3E

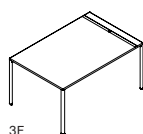

3F

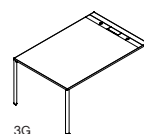

3G

150 x 50

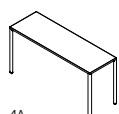

4A

150 x 75

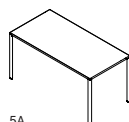

5A

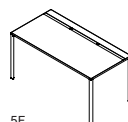

5F

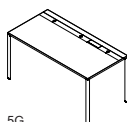

5G

150 x 100

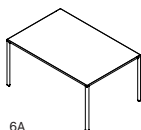

6A

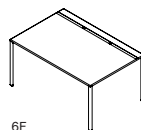

6F

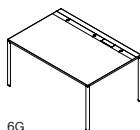

6G

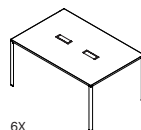

6X

150 x 150

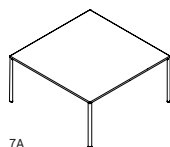

7A

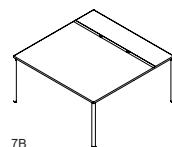

7B

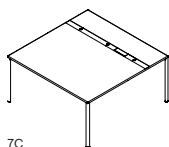

7C

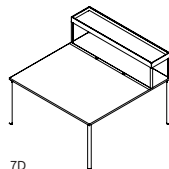

7D

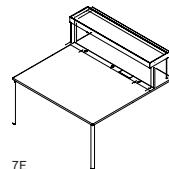

7E

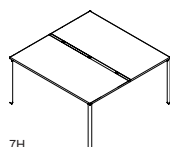

7H

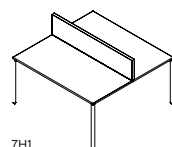

7H1

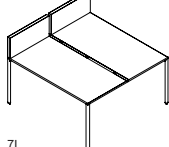

7I

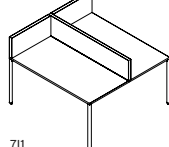

7I1

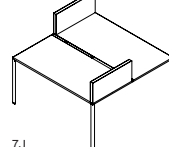

7J

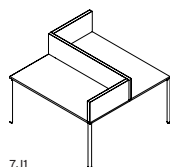

7J1

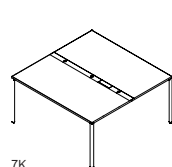

7K

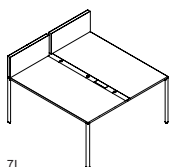

7L

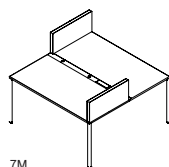

7M

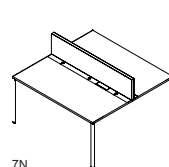

7N

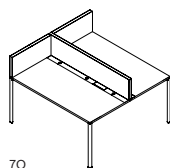

7O

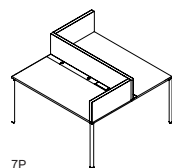

7P

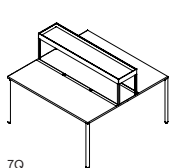

7Q

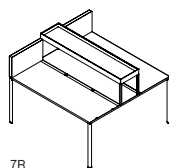

7R

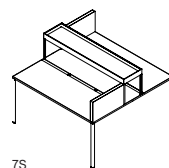

7S

# 24% rabatt ska dras av på angivna priser

## TABLE OVERVIEW

150 x 150

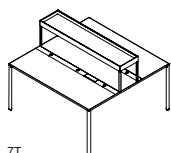

7T

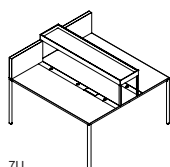

7U

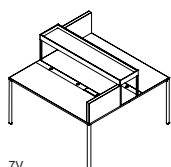

7V

200 x 75

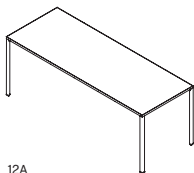

12A

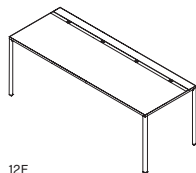

12F

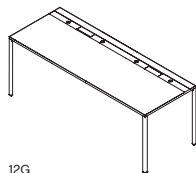

12G

200 x 100

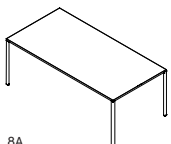

8A

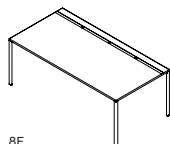

8F

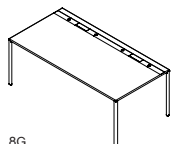

8G

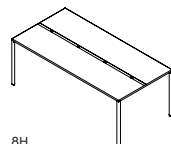

8H

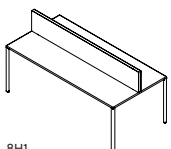

8H1

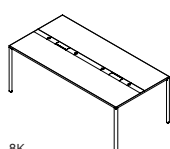

8K

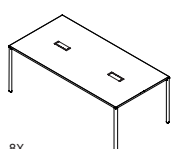

8X

200 x 150

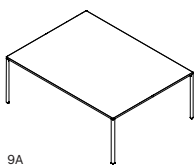

9A

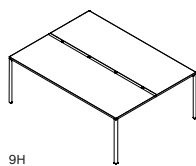

9H

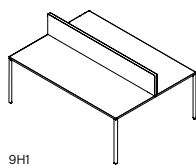

9H1

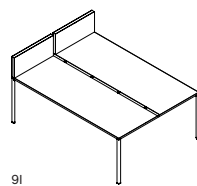

9I

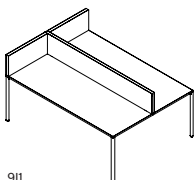

9I1

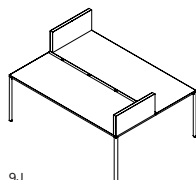

9J

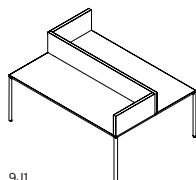

9J1

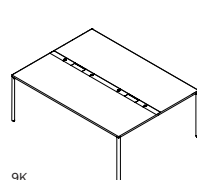

9K

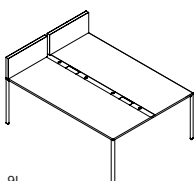

9L

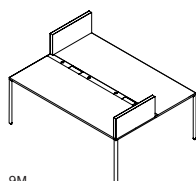

9M

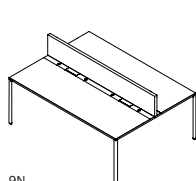

9N

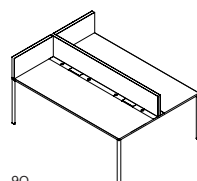

9O

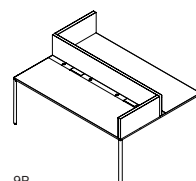

9P

250 x 100

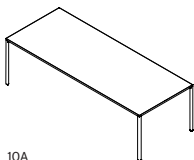

10A

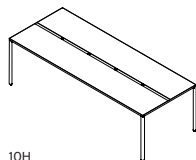

10H

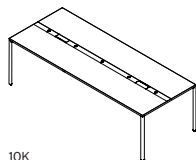

10K

300 x 100

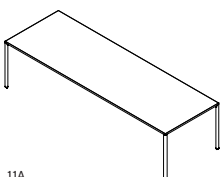

11A

# 24% rabatt ska dras av på angivna priser

## HIGH TABLE OVERVIEW

100 x 150

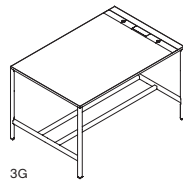
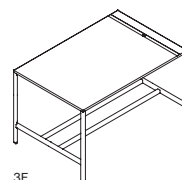
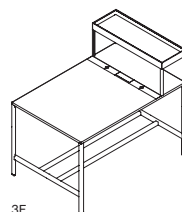
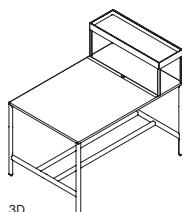
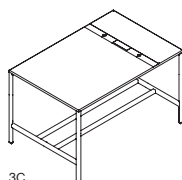
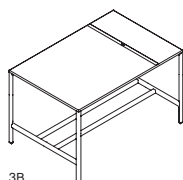

150 x 75

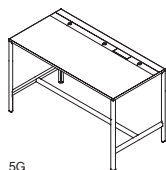
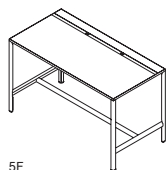
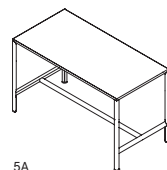

150 x 100

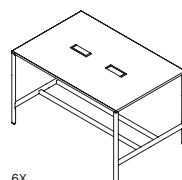
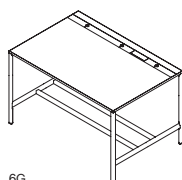
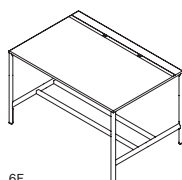
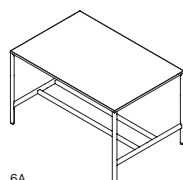

200 x 100

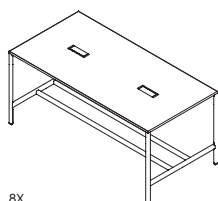
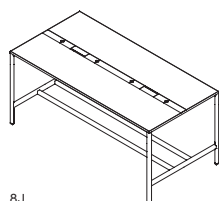
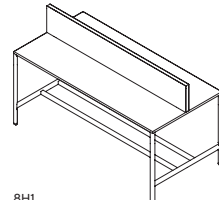
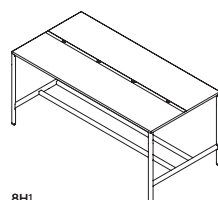
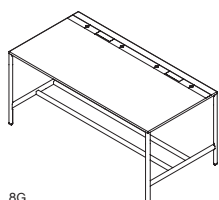
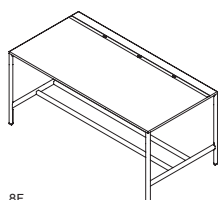
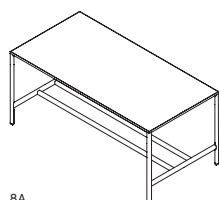

200 x 75

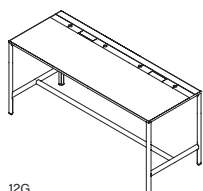
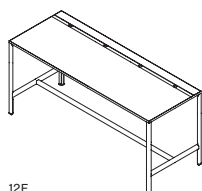
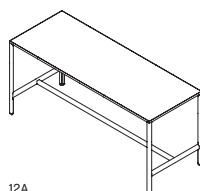

# 24% rabatt ska dras av på angivna priser

## TABLETOP OVERVIEW

100 x 50									
	1A								
100 x 100									
	2A	2B	2C	2D	2E				
100 x 150									
		3B	3C	3D	3E	3F	3G		
150 x 50									
	4A								
150 x 75									
	5A	5F	5G						
150 x 100									
	6A	6F	6G	6X					
150 x 150									
	7A	7B	7C	7D	7E				
	7H	7H1	7I	7I1	7J				
	7J1	7K	7L	7M	7N				
	7O	7P	7Q	7R	7S				



# 24% rabatt ska dras av på angivna priser

## TABLETOP OVERVIEW

150 x 150

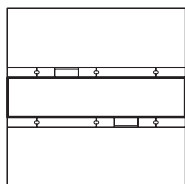

7T

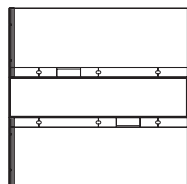

7U

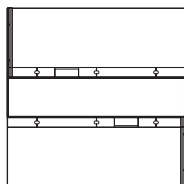

7V

200 x 100



8A

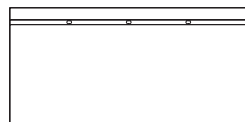

8F

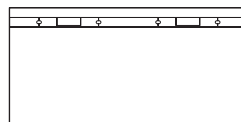

8G

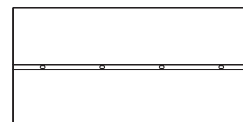

8H

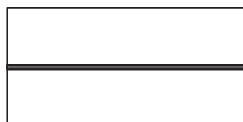

8H1

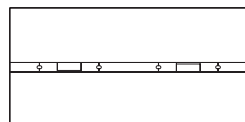

8K



8X

200 x 150



9A

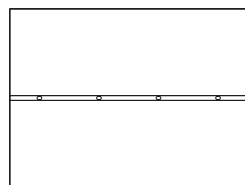

9H

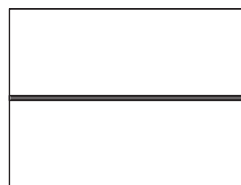

9H1

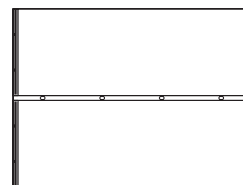

9I

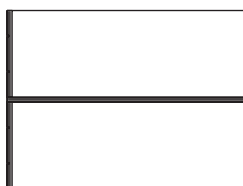

9I1

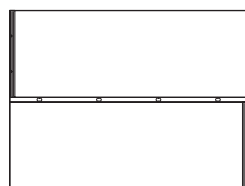

9J

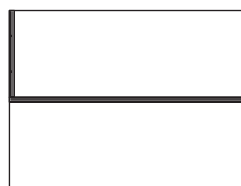

9J1

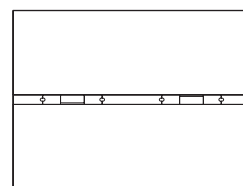

9K

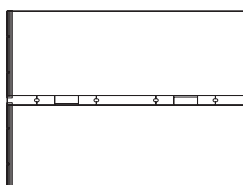

9L

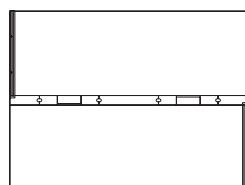

9M

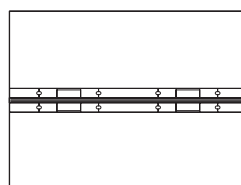

9N

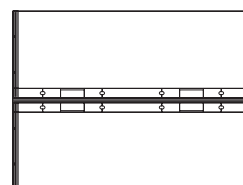

9O

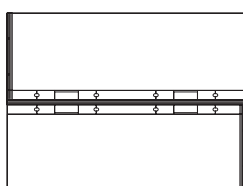

9P

250 x 100



10A

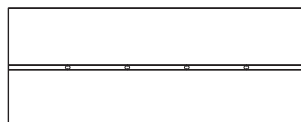

10H

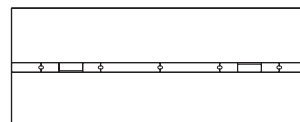

10K

300 x 100

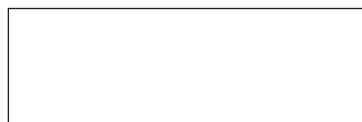

11A

# 24% rabatt ska dras av på angivna priser

## SUGGESTED COMBINATIONS

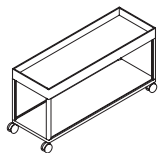

NO Combination 101

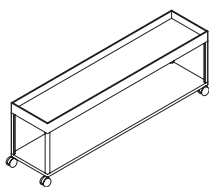

NO Combination 102

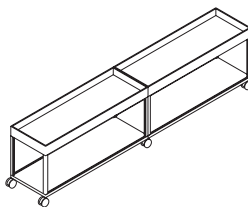

NO Combination 103

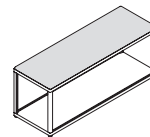

NO Bench combination 100

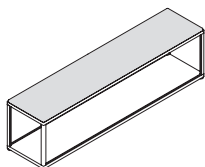

NO Bench combination 150

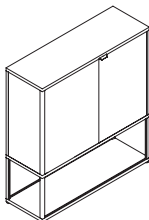

NO Combination 201

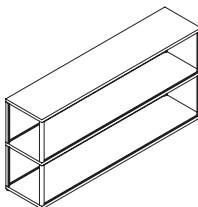

NO Combination 202

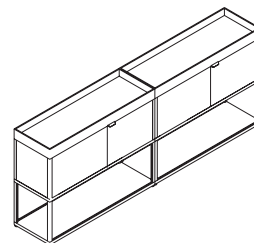

NO Combination 203

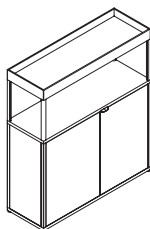

NO Combination 204

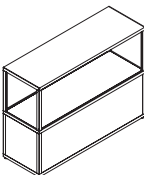

NO Combination 205

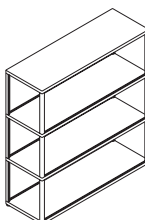

NO Combination 301

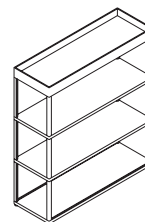

NO Combination 303

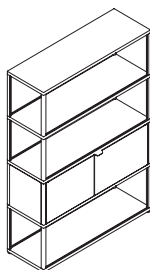

NO Combination 401

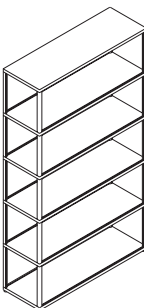

NO Combination 501

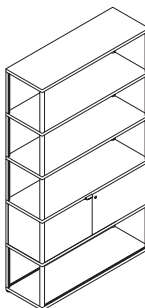

NO Combination 502

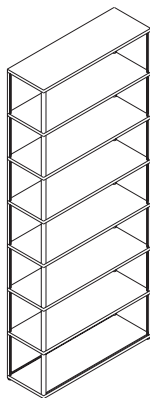

NO Combination 701

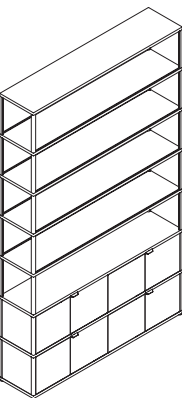

NO Combination 702

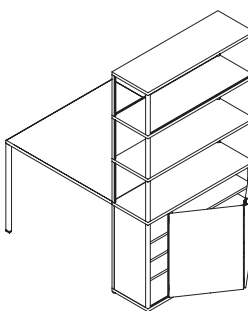

NO Table Combination 401

# 24% rabatt ska dras av på angivna priser

## DIMENSIONS

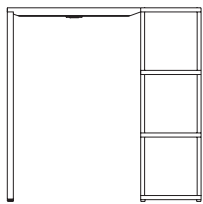

H110 cm

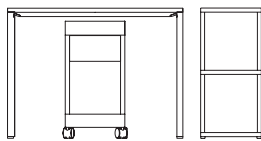

H68 cm

H74 cm

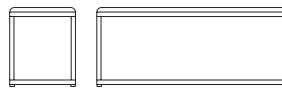

H45 cm

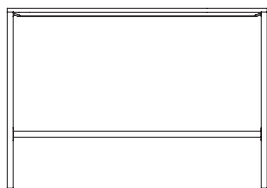

H105 cm

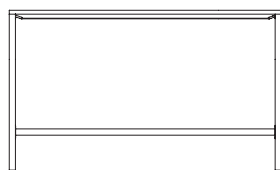

H95 cm

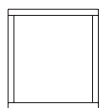

H38,5 cm

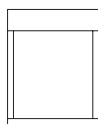

H44,5 cm



H74 cm



H79,5 cm



H110 cm

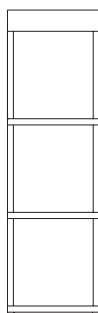

H115 cm

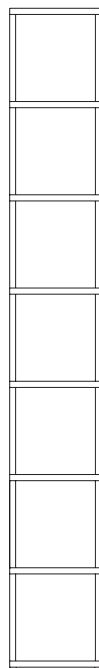

H250 cm

# 24% rabatt ska dras av på angivna priser

## SHELF TOP | 34 | 100 | 150

23 mm shelf. Powder coated extruded aluminium. End parts in die cast aluminium.  
Please note that wall- or floor safety brackets are needed above a certain height.  
Please see the New Order instruction manuals for further information or contact our sales team.

Stock item



MATERIAL	COLOUR			
	Army	Charcoal	Light grey	Red
Powder coated extruded aluminium	•	•	•	•

VARIANT	DIMENSION	BOX DIMENSION   WEIGHT	PACKAGING	PRICE
W34	W34 x D34 x H2,3 W13.39" x D13.39" x H0.91"	1 pcs. W39 x D39.5 x H10.5   2.31 kg	1 box   1 pcs.	1.130,00
W100	W100 x D34 x H2,3 W39.37" x D13.39" x H0.91"	1 pcs. W105 x D39.5 x H10.5   6.4 kg	1 box   1 pcs.	2.120,00
W150	W150 x D34 x H2,3 W59.06" x D13.39" x H0.91"	1 pcs. W155 x D39.5 x H10.5   9.1 kg	1 box   1 pcs.	3.050,00

## SHELF MIDDLE | 34 | 100 | 150

23 mm shelf. Powder coated extruded aluminium. End parts in die cast aluminium.  
Please note that wall- or floor safety brackets are needed above a certain height.  
Please see the New Order instruction manuals for further information or contact our sales team.

Stock item

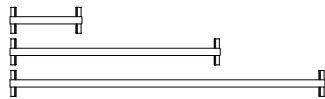

MATERIAL	COLOUR			
	Army	Charcoal	Light grey	Red
Powder coated extruded aluminium	•	•	•	•

VARIANT	DIMENSION	BOX DIMENSION   WEIGHT	PACKAGING	PRICE
W34	W34 x D34 x H2,3 W13.39" x D13.39" x H0.91"	1 pcs. W39 x D39.5 x H14   2.46 kg	1 box   1 pcs.	1.130,00
W100	W100 x D34 x H2,3 W39.37" x D13.39" x H0.91"	1 pcs. W105 x D39.5 x H14   6.63 kg	1 box   1 pcs.	2.120,00
W150	W150 x D34 x H2,3 W59.06" x D13.39" x H0.91"	1 pcs. W155 x D39.5 x H14   9.18 kg	1 box   1 pcs.	3.050,00

## SHELF BOTTOM | 34 | 100 | 150

23 mm shelf. Powder coated extruded aluminium. End parts in die cast aluminium.  
Incl. adjustable feet. Please note that wall- or floor safety brackets are needed above a certain height.  
Please see the New Order instruction manuals for further information or contact our sales team.

Stock item

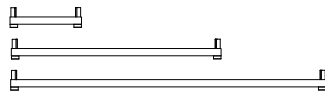

MATERIAL	COLOUR			
	Army	Charcoal	Light grey	Red
Powder coated extruded aluminium	•	•	•	•

VARIANT	DIMENSION	BOX DIMENSION   WEIGHT	PACKAGING	PRICE
W34	W34 x D34 x H2,3 W13.39" x D13.39" x H0.91"	1 pcs. W39 x D39.5 x H10.5   2.42 kg	1 box   1 pcs.	1.130,00
W100	W100 x D34 x H2,3 W39.37" x D13.39" x H0.91"	1 pcs. W105 x D39.5 x H10.5   6.21 kg	1 box   1 pcs.	2.120,00
W150	W150 x D34 x H2,3 W59.06" x D13.39" x H0.91"	1 pcs. W155 x D39.5 x H10.5   9 kg	1 box   1 pcs.	3.050,00

# 24% rabatt ska dras av på angivna priser

## TRAY TOP | 100 | 150

80 mm tray. Powder coated aluminum sides with steel bottom. End parts in die cast aluminium.  
Please note that wall- or floor safety brackets are needed above a certain height.  
Please see the New Order instruction manuals for further information or contact our sales team.

Stock item

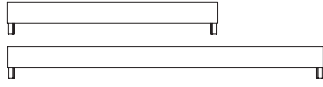

					MATERIAL				
					COLOUR	Army	Charcoal	Light grey	Red
					Powder coated extruded aluminium	•	•	•	•
VARIANT	DIMENSION	BOX DIMENSION   WEIGHT	PACKAGING	PRICE					
W100	W100 x D34 x H8 W39.37" x D13.39" x H3.15"	1 pcs. W105 x D39.5 x H16   5.92 kg	1 box   1 pcs.	2.270,00					
W150	W150 x D34 x H8 W59.06" x D13.39" x H3.15"	1 pcs. W155 x D39.5 x H16   8.3 kg	1 box   1 pcs.	3.200,00					

# 24% rabatt ska dras av på angivna priser

## SINGLE PROFILE | SET OF 4

Powder coated extruded aluminium. Incl. Premounted set screws. Single or double height.

Stock item

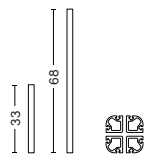

MATERIAL	COLOUR
Powder coated extruded aluminium	Army Charcoal Light grey Red

VARIANT	DIMENSION	BOX DIMENSION   WEIGHT	PACKAGING	PRICE
H33	W2,2 x D2,2 x H33 W0.87" x D0.87" x H12.99"	1 pcs. W34.5 x D5.5 x H5.5   0.87 kg	1 box   1 pcs.	490,00
H68	W2,2 x D2,2 x H68 W0.87" x D0.87" x H26.77"	1 pcs. W70 x D5.5 x H5.5   1.8 kg	1 box   1 pcs.	900,00

## DOUBLE PROFILE | SET OF 2

Powder coated extruded aluminium. Incl. premounted set screws. Single or double height.

Stock item

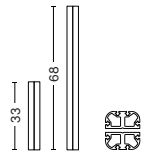

MATERIAL	COLOUR
Powder coated extruded aluminium	Army Charcoal Light grey Red

VARIANT	DIMENSION	BOX DIMENSION   WEIGHT	PACKAGING	PRICE
H33	W2,2 x D2,2 x H33 W0.87" x D0.87" x H12.99"	1 pcs. W34.5 x D5.5 x H5.5   0.87 kg	1 box   1 pcs.	490,00
H68	W2,2 x D2,2 x H68 W0.87" x D0.87" x H26.77"	1 pcs. W70 x D5.5 x H5.5   1.8 kg	1 box   1 pcs.	900,00

## CORNER PROFILE | SET OF 1 + 1

Powder coated extruded aluminium. Incl. Premounted set screws. Single or double height.

Set of 1 x single + 1 x triple.

Stock item

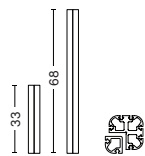

MATERIAL	COLOUR
Powder coated extruded aluminium	Army Charcoal Light grey Red

VARIANT	DIMENSION	BOX DIMENSION   WEIGHT	PACKAGING	PRICE
H33	W2,2 x D2,2 x H33 W0.87" x D0.87" x H12.99"	1 pcs. W34.5 x D5.5 x H5.5   0.87 kg	1 box   1 pcs.	490,00
H68	W2,2 x D2,2 x H68 W0.87" x D0.87" x H26.77"	1 pcs. W70 x D5.5 x H5.5   1.8 kg	1 box   1 pcs.	900,00

# 24% rabatt ska dras av på angivna priser

## BENCHTOP | 34 | 100 | 150

MDF board with foam top upholstered with fabric or leather. Premounted with velcro for mounting. Please note shelving below benchtop should be open without panels, drawers or doors.

Order produced

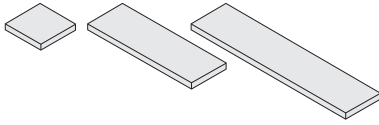

VARIANT	DIMENSION	BOX DIMENSION   WEIGHT	PACKAGING	FABRIC	PRICE
	W34 x D34 x H2,3 W13.39" x D13.39" x H0.91"	1 pcs. W39 x D36 x H30   2 kg	1 box   1 pcs.	Remix Surface By HAY Steelcut Steelcut Trio Canvas Sierra Black Sense Cognac	1.180,00 1.180,00 1.250,00 1.250,00 1.330,00 1.730,00 2.200,00
VARIANT	DIMENSION	BOX DIMENSION   WEIGHT	PACKAGING	FABRIC	PRICE
	W100 x D34 x H2,3 W39.37" x D13.39" x H0.91"	1 pcs. W105 x D36 x H5   3 kg	1 box   1 pcs.	Remix Surface By HAY Steelcut Steelcut Trio Canvas Sierra Black Sense Cognac	2.350,00 2.350,00 2.500,00 2.500,00 2.660,00 3.300,00 4.070,00
VARIANT	DIMENSION	BOX DIMENSION   WEIGHT	PACKAGING	FABRIC	PRICE
	W150 x D34 x H2,3 W59.06" x D13.39" x H0.91"	1 pcs. W155 x D36 x H5   3.5 kg	1 box   1 pcs.	Remix Surface By HAY Steelcut Steelcut Trio Canvas Sierra Black Sense Cognac	3.370,00 3.370,00 3.600,00 3.600,00 3.850,00 4.850,00 6.100,00



# 24% rabatt ska dras av på angivna priser

## WOODEN PANELS AND DOOR | 100 | 150

Set of doors and panels. 6 mm MDF with front and back veneer. 100 cm | Set of 1 sliding door, 2 side panels and 1 back panel. Opening right. 150 cm | Set of 2 doors, 2 sides panels and 1 back panel. Opening right and left. Incl. handle in Army, Light Grey or Charcoal. Please note that wooden panels and doors are not suitable for hard contract use.

Order produced

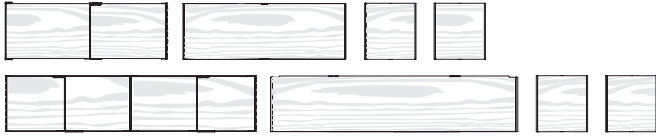

FINISH	SIZE	
	W100	W150
Untreated oak veneer	•	•
Untreated ash veneer	•	•

VARIANT	DIMENSION	BOX DIMENSION   WEIGHT	PACKAGING	PRICE
W100	DOOR 100 W95,5 x D0,7 x H33 cm W37.6" x D0.28" x H12.99"	W108,5 x D43 x H4,2 cm   7,50 kg	1 box   1 pcs.	3.130,00
	BACK PANEL 100 W95 x D0,7 x H33 cm W37.40" x D0.28" x H12.99"			
	SIDE PANEL W29,5 x D0,7 x H33 cm W11.61" x D0.28" x H12.99"			

VARIANT	DIMENSION	BOX DIMENSION   WEIGHT	PACKAGING	PRICE
W150	DOOR 150 W145,5 x D0,7 x H33 cm W57.29" x D0.28" x H12.99"	W163,50 x D45 x H4,2 cm   10 kg	1 box   1 pcs.	6.300,00
	BACK PANEL 150 W145 x D0,7 x H33 cm W57.09" x D0.28" x H12.99"			
	SIDE PANEL W29,5 x D0,7 x H33 cm W11.61" x D0.28" x H12.99"			

## WOODEN PANELS AND DOOR | 100 LEFT

6 mm MDF with front and back veneer. Set of 1 sliding door, 2 side panels and 1 back panel. Opening Left. Incl. handle in Army, Light Grey or Charcoal. Please note that wooden panels and doors are not suitable for hard contract use.

Order produced



FINISH	SIZE	
	W100	
Untreated oak veneer	•	
Untreated ash veneer	•	

VARIANT	DIMENSION	BOX DIMENSION   WEIGHT	PACKAGING	PRICE
W100	DOOR 100 W95,5 x D0,7 x H33 cm W37.6" x D0.28" x H12.99"	W108,5 x D43 x H4,2 cm   7,50 kg	1 box   1 pcs.	3.130,00
	BACK PANEL 100 W95 x D0,7 x H33 cm W37.40" x D0.28" x H12.99"			
	SIDE PANEL W29,5 x D0,7 x H33 cm W11.61" x D0.28" x H12.99"			

# 24% rabatt ska dras av på angivna priser

## WOODEN WALL PANELS AND DOOR | 100 | 150

Set of doors and panels. 6 mm MDF with front and back veneer.  
 100 cm | Set of 1 sliding door, 2 side panels and 1 wall panel. Opening right. 150 cm | Set of 2 doors, 2 sides panels and 1 wall panel. Opening right and left. Incl. handle in Army, Light Grey or Charcoal. Wall brackets are sold separately. Please note that wooden panels and doors are not suitable for hard contract use.

Order produced

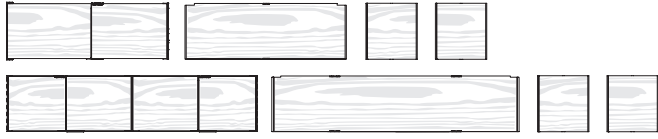

FINISH	SIZE	
	W100	W150
Untreated oak veneer	•	•
Untreated ash veneer	•	•

VARIANT	DIMENSION	BOX DIMENSION   WEIGHT	PACKAGING	PRICE
W100	<p>DOOR 100                      W95,5 x D0,7 x H33 cm                      W37.6" x D0.28" x H12.99"</p> <p>BACK PANEL 100                      W95 x D0,7 x H33 cm                      W37.40" x D0.28" x H12.99"</p> <p>SIDE PANEL                      W29,5 x D0,7 x H33 cm                      W11.61" x D0.28" x H12.99"</p>	W108,5 x D43 x H4,2 cm   7,50 kg	1 box   1 pcs.	3.300,00

VARIANT	DIMENSION	BOX DIMENSION   WEIGHT	PACKAGING	PRICE
W150	<p>DOOR 150                      W145,5 x D0,7 x H33 cm                      W57.29" x D0.28" x H12.99"</p> <p>BACK PANEL 150                      W145 x D0,7 x H33 cm                      W57.09" x D0.28" x H12.99"</p> <p>SIDE PANEL                      W29,5 x D0,7 x H33 cm                      W11.61" x D0.28" x H12.99"</p>	W163,50 x D45 x H4,2 cm   10 kg	1 box   1 pcs.	6.400,00

## WOODEN WALL PANELS AND DOOR | 100 LEFT

Set of doors and panels. 6 mm MDF with front and back veneer.  
 Set of 1 sliding door, 2 side panels and 1 wall panel. Opening Left. Incl. handle in Army, Light Grey or Charcoal. Wall brackets are sold separately. Please note that wooden panels and doors are not suitable for hard contract use.

Order produced



FINISH	SIZE	
	W100	
Untreated oak veneer	•	
Untreated ash veneer	•	

VARIANT	DIMENSION	BOX DIMENSION   WEIGHT	PACKAGING	PRICE
W100	<p>DOOR 100                      W95,5 x D0,7 x H33 cm                      W37.6" x D0.28" x H12.99"</p> <p>BACK PANEL 100                      W95 x D0,7 x H33 cm                      W37.40" x D0.28" x H12.99"</p> <p>SIDE PANEL                      W29,5 x D0,7 x H33 cm                      W11.61" x D0.28" x H12.99"</p>	W108,5 x D43 x H4,2 cm   7,50 kg	1 box   1 pcs.	3.300,00

# 24% rabatt ska dras av på angivna priser

## STEEL SIDE PANEL | 34

### STEEL SIDE PANEL DOUBLE HEIGHT 34

Powder coated steel.

Order produced

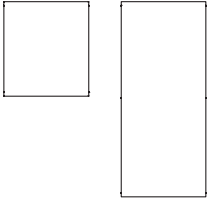

MATERIAL	COLOUR		
	Army	Charcoal	Light grey
Powder coated steel	•	•	•

VARIANT	DIMENSION	BOX DIMENSION   WEIGHT	PACKAGING	PRICE
H33	W29,5 x D1,6 x H33 W11.61" x D0.63" x H12.99"	1 pcs. W29.5 x D1.6 x H33   1.5 kg	1 box   1 pcs.	500,00
H68	W29,5 x D1,6 x H68 W11.61" x D0.63" x H26.77"	1 pcs. W29.5 x D1.6 x H68   3 kg	1 box   1 pcs.	790,00

## STEEL SIDE PANEL DOUBLE HEIGHT FOR ADJUSTABLE SHELF | 34

Powder coated steel. Adjustable shelves are ordered separately.

Order produced

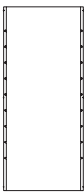

MATERIAL	COLOUR		
	Army	Charcoal	Light grey
Powder coated steel	•	•	•

VARIANT	DIMENSION	BOX DIMENSION   WEIGHT	PACKAGING	PRICE
W100	W95,5 x D34 x H2,2 W37.60" x D13.39" x H0.87"	1 pcs. W95.5 x D34 x H2.2   4.5 kg	1 box   1 pcs.	940,00

## STEEL SHELF FOR ADJUSTABLE PANELS | 100

1,25 mm shelf in powder coated steel. Incl. 4 pins in POM.

Order produced



MATERIAL	COLOUR		
	Army	Charcoal	Light grey
Powder coated steel	•	•	•

VARIANT	DIMENSION	BOX DIMENSION   WEIGHT	PACKAGING	PRICE
	W95,5 x D34 x H2,2 W37.60" x D13.39" x H0.87"	1 pcs. W95.5 x D34 x H2.2   4.5 kg	1 box   1 pcs.	940,00

## PINS FOR ADJUSTABLE SHELF | SET OF 4

Set of 4 pins in POM

Order produced



MATERIAL	COLOUR		
	Army	Charcoal	Light grey
POM	•	•	•

VARIANT	DIMENSION	BOX DIMENSION   WEIGHT	PACKAGING	PRICE
SET OF 4	W5 x D5 x H1 W1.97" x D1.97" x H0.39"	1 pcs. W5 x D5 x H1   0.04 kg	1 box   1 pcs.	130,00

# 24% rabatt ska dras av på angivna priser

## STEEL BACK PANEL | 100 | 150

Powder coated steel.

Order produced



MATERIAL	COLOUR		
	Army	Charcoal	Light grey
Powder coated steel	•	•	•

VARIANT	DIMENSION	BOX DIMENSION   WEIGHT	PACKAGING	PRICE
W100	W95,5 x D1,6 x H33 W37.60" x D0.63" x H12.99"	1 pcs. W95.5 x D1.6 x H33   4.5 kg	1 box   1 pcs.	790,00
W150	W145,5 x D1,6 x H33 W57.28" x D0.63" x H12.99"	1 pcs. W145.5 x D1.6 x H33   7 kg	1 box   1 pcs.	1.570,00

## STEEL BACK PANEL DOUBLE HEIGHT | 100

Powder coated steel

Order produced



MATERIAL	COLOUR		
	Army	Charcoal	Light grey
Powder coated steel	•	•	•

VARIANT	DIMENSION	BOX DIMENSION   WEIGHT	PACKAGING	PRICE
W100	W95,5 x D1,6 x H68 W37.60" x D0.63" x H26.77"	1 pcs. W95.5 x D1.6 x H68   9 kg	1 box   1 pcs.	1.250,00

## STEEL WALL BACK PANEL | 100 | 150

Powder coated steel. With cutouts for wall brackets.

Order produced

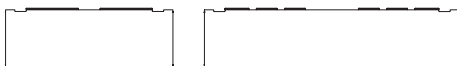

MATERIAL	COLOUR		
	Army	Charcoal	Light grey
Powder coated steel	•	•	•

VARIANT	DIMENSION	BOX DIMENSION   WEIGHT	PACKAGING	PRICE
W100	W95,5 x D1,6 x H33 W37.60" x D0.63" x H12.99"	1 pcs. W95.5 x D1.6 x H33   4.5 kg	1 box   1 pcs.	940,00
W150	W145,5 x D1,6 x H33 W57.28" x D0.63" x H12.99"	1 pcs. W145.5 x D1.6 x H33   7 kg	1 box   1 pcs.	1.730,00

## STEEL WALL BACK PANEL DOUBLE HEIGHT | 100

Powder coated steel.

Order produced



MATERIAL	COLOUR		
	Army	Charcoal	Light grey
Powder coated steel	•	•	•

VARIANT	DIMENSION	BOX DIMENSION   WEIGHT	PACKAGING	PRICE
H68	W95,5 x D1,6 x H68 cm W37.60" x D0.63" x H26.77"	W95,5 x D1,6 x H68 cm   9 kg	1 box   1 pcs.	1.400,00

# 24% rabatt ska dras av på angivna priser

## STEEL TABLE PANEL | 34

### STEEL TABLE PANEL DOUBLE HEIGHT | 34

Powder coated steel. Used under the tables when connecting tables with shelf or tray units. Incl. cutout for cables.

Order produced

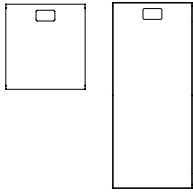

MATERIAL	COLOUR		
	Army	Charcoal	Light grey
Powder coated steel	•	•	•

VARIANT	DIMENSION	BOX DIMENSION   WEIGHT	PACKAGING	PRICE
H32	W29,5 x D1,6 x H32 W11.61" x D0.63" x H12.60"	1 pcs. W29.5 x D1.6 x H32   1.5 kg	1 box   1 pcs.	630,00
H67	W29,5 x D1,6 x H67 W11.61" x D0.63" x H26.38"	1 pcs. W29.5 x D1.6 x H67   3 kg	1 box   1 pcs.	1.100,00

## STEEL TABLE PANEL DOUBLE HEIGHT FOR ADJUSTABLE SHELF | 34

Powder coated steel. Used under the tables when connecting tables with shelf or tray units. Incl. cutout for cables.

Order produced

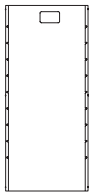

MATERIAL	COLOUR		
	Army	Charcoal	Light grey
Powder coated steel	•	•	•

VARIANT	DIMENSION	BOX DIMENSION   WEIGHT	PACKAGING	PRICE
H67	W29,5 x D1,6 x H67 W11.61" x D0.63" x H26.38"	1 pcs. W29.5 x D1.6 x H67   3 kg	1 box   1 pcs.	940,00

## STEEL TABLE BACK PANEL | 100 | 150

Powder coated steel. Used under the tables when connecting tables with shelf or tray units. Incl. cutout for cables.

Order produced

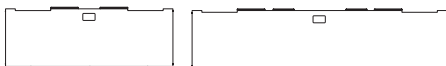

MATERIAL	COLOUR		
	Army	Charcoal	Light grey
Powder coated steel	•	•	•

VARIANT	DIMENSION	BOX DIMENSION   WEIGHT	PACKAGING	PRICE
W100	W95,5 x D1,6 x H33 W37.60" x D0.63" x H12.99"	1 pcs. W95.5 x D1.6 x H33   4.5 kg	1 box   1 pcs.	940,00
W150	W145,5 x D1,6 x H33 W57.28" x D0.63" x H12.99"	1 pcs. W145.5 x D1.6 x H33   7 kg	1 box   1 pcs.	1.730,00

# 24% rabatt ska dras av på angivna priser

## STEEL TABLE BACK PANEL DOUBLE HEIGHT | 100

Powder coated steel. Used under the tables when connecting tables with shelf or tray units. Incl. cutout for cables.

Order produced

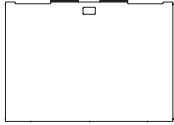

MATERIAL	COLOUR		
	Army	Charcoal	Light grey
Powder coated steel	•	•	•

VARIANT	DIMENSION	BOX DIMENSION   WEIGHT	PACKAGING	PRICE
W100	W95,5 x D1,6 x H68 W37.60" x D0.63" x H26.77"	1 pcs. W95.5 x D1.6 x H68   9 kg	1 box   1 pcs.	1.400,00

## STEEL PERFORATED BACK PANEL | 100 | 150

Powder coated steel

Order produced

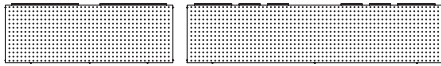

MATERIAL	COLOUR		
	Army	Charcoal	Light grey
Powder coated steel	•	•	•

VARIANT	DIMENSION	BOX DIMENSION   WEIGHT	PACKAGING	PRICE
W100	W95,5 x D1,6 x H33 W37.60" x D0.63" x H12.99"	1 pcs. W95.5 x D1.6 x H33   4.5 kg	1 box   1 pcs.	1.400,00
W150	W145,5 x D1,6 x H33 W57.28" x D0.63" x H12.99"	1 pcs. W145.5 x D1.6 x H33   7 kg	1 box   1 pcs.	2.350,00

## STEEL PERFORATED BACK PANEL DOUBLE HEIGHT | 100

Powder coated steel.

Order produced

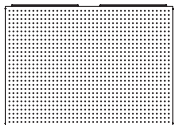

MATERIAL	COLOUR		
	Army	Charcoal	Light grey
Powder coated steel	•	•	•

VARIANT	DIMENSION	BOX DIMENSION   WEIGHT	PACKAGING	PRICE
W100	W95,5 x D1,6 x H68 W37.60" x D0.63" x H26.77"	1 pcs. W95.5 x D1.6 x H68   9 kg	1 box   1 pcs.	2.200,00

# 24% rabatt ska dras av på angivna priser

## MOUNTING ADAPTER TRAY

Plastic

Stock item

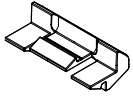

MATERIAL	COLOUR		
	Army	Charcoal	Light grey
Plastic	•	•	•

VARIANT	DIMENSION	BOX DIMENSION   WEIGHT	PACKAGING	PRICE
PLASTIC	W4 x D1 x H1 W1.57" x D0.39" x H0.39"	1 pcs. W5 x D1 x H1   0.02 kg	1 box   1 pcs.	49,00

## BACK PANEL FASTENER ADAPTER TRAY

Plastic

Stock item

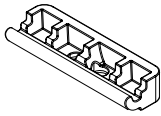

MATERIAL	COLOUR		
	Army	Charcoal	Light grey
Plastic	•	•	•

VARIANT	DIMENSION	BOX DIMENSION   WEIGHT	PACKAGING	PRICE
PLASTIC	W4 x D1 x H1 W1.57" x D0.39" x H0.39"	1 pcs. W4 x D1 x H1   0.02 kg	1 box   1 pcs.	49,00



# 24% rabatt ska dras av på angivna priser

## TEXTILE PANEL | 34 | 100 | 150

A foam-filled textile panel insert is mounted with fixed velcro onto a powder coated steel cover used on the outside or inside of the shelving. Textile on one side. Steel cover in army, charcoal or light grey.

Order produced

VARIANT	DIMENSION	BOX DIMENSION   WEIGHT	PACKAGING	FABRIC	PRICE	COVER	
						COLOUR	Army Charcoal Light grey
						Powder coated steel	• • •
W34	W29,5 x D1,6 x H68 cm W11.61" x D0.63" x H26.77"	W29,5 x D1,6 x H33 cm   1,50 kg W29 x D1 x H32,5 cm   0,20 kg	1 box   1 pcs.	Remix Surface By HAY Steelcut Steelcut Trio Canvas	1.730,00 1.730,00 1.960,00 1.960,00 2.030,00		
W100	W95,5 x D1,6 x H33 cm W37.6" x D0.63" x H12.99"	W95,5 x D1,6 x H33 cm   4,5 kg W95 x D1 x H32,5 cm   0,80 kg	1 box   1 pcs.	Remix Surface By HAY Steelcut Steelcut Trio Canvas	2.990,00 2.990,00 3.440,00 3.440,00 3.600,00		
W150	W145,5 x D1,6 x H33 cm W57.28" x D0.637" x H12.99"	W145,5 x D1,6 x H33 cm   7 kg W145 x D1 x H32,5 cm   1,20 kg	1 box   1 pcs.	Remix Surface By HAY Steelcut Steelcut Trio Canvas	4.390,00 4.390,00 5.030,00 5.030,00 5.260,00		

## INSIDE TEXTILE PANEL | 34 | 100 | 150

A foam-filled textile panel insert is mounted with fixed velcro onto a powder coated steel cover used on the outside or inside of the shelving. Textile on one side. Steel cover in army, charcoal or light grey.

Order produced

VARIANT	DIMENSION	BOX DIMENSION   WEIGHT	PACKAGING	FABRIC	PRICE	COVER	
						COLOUR	Army Charcoal Light grey
						Powder coated steel	• • •
W34	W29,5 x D1,6 x H68 cm W11.61" x D0.63" x H26.77"	W29,5 x D1,6 x H33 cm   1,50 kg W29 x D1 x H32,5 cm   0,20 kg	1 box   1 pcs.	Remix Surface By HAY Steelcut Steelcut Trio Canvas	1.600,00 1.600,00 1.830,00 1.830,00 1.900,00		
W100	W95,5 x D1,6 x H33 cm W37.6" x D0.63" x H12.99"	W95,5 x D1,6 x H33 cm   4,5 kg W95 x D1 x H32,5 cm   0,80 kg	1 box   1 pcs.	Remix Surface By HAY Steelcut Steelcut Trio Canvas	2.840,00 2.840,00 3.290,00 3.290,00 3.450,00		
W150	W145,5 x D1,6 x H33 cm W57.28" x D0.637" x H12.99"	W145,5 x D1,6 x H33 cm   7 kg W145 x D1 x H32,5 cm   1,20 kg	1 box   1 pcs.	Remix Surface By HAY Steelcut Steelcut Trio Canvas	4.230,00 4.230,00 4.870,00 4.870,00 5.100,00		

# 24% rabatt ska dras av på angivna priser

## TEXTILE SIDE PANEL DOUBLE HEIGHT | 34

A foam-filled textile panel insert is mounted with fixed velcro onto a powder coated steel cover used on the outside or inside of the shelving. Textile on one side. Steel cover in army, charcoal or light grey.

Order produced



COVER	COLOUR		
	Army	Charcoal	Light grey
Powder coated steel	•	•	•

VARIANT	DIMENSION	BOX DIMENSION   WEIGHT	PACKAGING	FABRIC	PRICE
H68	W29,5 x D1,6 x H68 cm W11.61" x D0.63" x H26.77"	W29,5 x D1,6 x H68 cm   3 kg W29 cm   xD1 x H67,5 cm   0,50 kg	1 box   1 pcs.	Remix Surface By HAY Steelcut Steelcut Trio Canvas	2.270,00 2.270,00 2.510,00 2.510,00 2.590,00

## INSIDE TEXTILE SIDE PANEL DOUBLE HEIGHT | 34

A foam-filled textile panel insert is mounted with fixed velcro onto a powder coated steel cover used on the outside or inside of the shelving. Textile on one side. Steel cover in army, charcoal or light grey.

Order produced



COVER	COLOUR		
	Army	Charcoal	Light grey
Powder coated steel	•	•	•

VARIANT	DIMENSION	BOX DIMENSION   WEIGHT	PACKAGING	FABRIC	PRICE
H68	W29,5 x D1,6 x H68 cm W11.61" x D0.63" x H26.77"	W29,5 x D1,6 x H68 cm   3 kg W29 cm   xD1 x H67,5 cm   0,50 kg	1 box   1 pcs.	Remix Surface By HAY Steelcut Steelcut Trio Canvas	2.120,00 2.120,00 2.360,00 2.360,00 2.440,00

# 24% rabatt ska dras av på angivna priser

## TEXTILE BACK PANEL DOUBLE HEIGHT | 100

A foam-filled textile panel insert is mounted with fixed velcro onto a powder coated steel cover used on the outside or inside of the shelving. Textile on one side. Steel cover in army, charcoal or light grey.

Order produced



COVER	COLOUR		
	Army	Charcoal	Light grey
Powder coated steel	•	•	•

VARIANT	DIMENSION	BOX DIMENSION   WEIGHT	PACKAGING	FABRIC	PRICE
W100	W95,5 x D1,6 x H68 cm W37.6" x D0.63" x H26.77"	W95,5 x D1,6 x H68 cm   9 kg W95 x D1 x 67,5 cm   1,70 kg	1 box   1 pcs.	Remix Surface By HAY Steelcut Steelcut Trio Canvas	3.670,00 3.670,00 4.150,00 4.150,00 4.300,00

## INSIDE TEXTILE BACK PANEL DOUBLE HEIGHT | 100

A foam-filled textile panel insert is mounted with fixed velcro onto a powder coated steel cover used on the outside or inside of the shelving. Textile on one side. Steel cover in army, charcoal or light grey.

Order produced



COVER	COLOUR		
	Army	Charcoal	Light grey
Powder coated steel	•	•	•

VARIANT	DIMENSION	BOX DIMENSION   WEIGHT	PACKAGING	FABRIC	PRICE
W100	W95,5 x D1,6 x H68 cm W37.6" x D0.63" x H26.77"	W95,5 x D1,6 x H68 cm   9 kg W95 x D1 x 67,5 cm   1,70 kg	1 box   1 pcs.	Remix Surface By HAY Steelcut Steelcut Trio Canvas	3.520,00 3.520,00 4.000,00 4.000,00 4.150,00

# 24% rabatt ska dras av på angivna priser

## STEEL SLIDING DOOR | 100 | 150

Powder coated steel. Incl. handle in extruded powder coated aluminium.

100 cm | 1 sliding door opening right.

150 cm | 2 sliding doors opening right and left.

Order produced

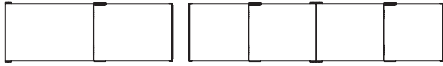

MATERIAL	COLOUR
	Army Charcoal Light grey

Powder coated steel | • • •

VARIANT	DIMENSION	BOX DIMENSION   WEIGHT	PACKAGING	PRICE
W100	W95,5 x D2,7 x H33 W37.60" x D1.06" x H12.99"	1 pcs. W95.5 x D2.7 x H33   6 kg	1 box   1 pcs.	2.160,00
W150	2 x W72,75 x D2,7 x H33 cm 2 x W28.64" x D1.06" x H12.99"	2 pcs.   W72,75 x D2,7 x H33 cm   4,50 kg	1 box   1 pcs.	3.120,00

## STEEL SLIDING DOOR | 100 LEFT

Powder coated steel. Incl. handle in extruded powder coated aluminium.

1 sliding door opening left.

Order produced

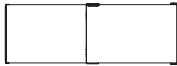

MATERIAL	COLOUR
	Army Charcoal Light grey

Powder coated steel | • • •

VARIANT	DIMENSION	BOX DIMENSION   WEIGHT	PACKAGING	PRICE
W100	W95,5 x D33 x H2,7 W37.60" x D12.99" x H1.06"	1 pcs. W95.5 x D33 x H2.7   6 kg	1 box   1 pcs.	2.160,00

# 24% rabatt ska dras av på angivna priser

## STEEL SLIDING DOOR PREPARED FOR LOCK | 100 | 150

Powder coated steel. Incl. handle in extruded powder coated aluminium.

100 cm | 1 sliding door opening right.

150 cm | 2 sliding doors opening right and left.

Prepared for Häfele Symo Universal HS 3 locking system, Type 0601-0700. The lock cylinder is packed separately. To be mounted by customer. Master key 210.113 is an option. Please specify the number of the lock cylinder and the key between 0601-700.

Please note that 2 cylinders are needed for 1 set of 150 cm doors.

Order produced



MATERIAL	COLOUR		
	Army	Charcoal	Light grey
Powder coated steel	•	•	•

VARIANT	DIMENSION	BOX DIMENSION   WEIGHT	PACKAGING	PRICE
W100	W95,5 x D2,7 x H33 W37.60" x D1.06" x H12.99"	1 pcs. W95.5 x D2.7 x H33   6 kg	1 box   1 pcs.	2.940,00
W150	2 x W72,75 x D2,7 x H33 cm 2 x W28.64" x D1.06" x H12.99"	2 pcs. W72,75 x D2,7 x H33 cm   4,50 kg	1 box   1 pcs.	4.680,00
<b>ADD-ON FOR LOCK</b>				
Lock cylinder - keys not incl. 210.41.603	W2,5 x D1,5 x H1,5 W0.98" x D0.59" x H0.59"	1 pcs. W5 x D2 x H2   0.1 kg	1 box   1 pcs.	+ 150,00
Extra Key for lock cylinder 210.11.058	W2,5 x D1,5 x H0,2 W0.98" x D0.59" x H0.08"	1 pcs. W4 x D1 x H1   0.02 kg	1 box   1 pcs.	+ 119,00

## STEEL SLIDING DOOR PREPARED FOR LOCK | 100 LEFT

Powder coated steel. Incl. handle in extruded powder coated aluminium.

1 sliding door opening left.

Prepared for Häfele Symo Universal HS 3 locking system, Type 0601-0700. The lock cylinder is packed separately. To be mounted by customer. Master key 210.113 is an option. Please specify the number of the lock cylinder and the key between 0601-700.

Order produced



MATERIAL	COLOUR		
	Army	Charcoal	Light grey
Powder coated steel	•	•	•

VARIANT	DIMENSION	BOX DIMENSION   WEIGHT	PACKAGING	PRICE
W100	W95,5 x D2,7 x H33 W37.60" x D1.06" x H12.99"	1 pcs. W95.5 x D2.7 x H33   6 kg	1 box   1 pcs.	2.940,00
<b>ADD-ON FOR LOCK</b>				
Lock cylinder - keys not incl. 210.41.603	W2,5 x D1,5 x H1,5 W0.98" x D0.59" x H0.59"	1 pcs. W5 x D2 x H2   0.1 kg	1 box   1 pcs.	+ 150,00
Extra Key for lock cylinder 210.11.058	W2,5 x D1,5 x H0,2 W0.98" x D0.59" x H0.08"	1 pcs. W4 x D1 x H1   0.02 kg	1 box   1 pcs.	+ 119,00

# 24% rabatt ska dras av på angivna priser

## STEEL SLIDING DOOR DOUBLE HEIGHT | 100

Powder coated steel. Incl. handle in extruded powder coated aluminium. 1 sliding door opening right. Adjustable screw in the bottom to make sure you get the best fit.

Order produced

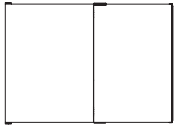

MATERIAL	COLOUR		
	Army	Charcoal	Light grey
Powder coated steel	•	•	•

VARIANT	DIMENSION	BOX DIMENSION   WEIGHT	PACKAGING	PRICE
W100	W95,5 x D2,7 x H68 W37.60" x D1.06" x H26.77"	1 pcs. W95.5 x D2.7 x H68   12 kg	1 box   1 pcs.	3.400,00

## STEEL SLIDING DOOR DOUBLE HEIGHT | 100 LEFT

Powder coated steel. Incl. handle in extruded powder coated aluminium. 1 sliding door opening left. Adjustable screw in the bottom to make sure you get the best fit.

Order produced

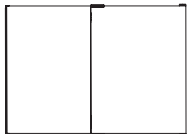

MATERIAL	COLOUR		
	Army	Charcoal	Light grey
Powder coated steel	•	•	•

VARIANT	DIMENSION	BOX DIMENSION   WEIGHT	PACKAGING	PRICE
W100	W95,5 x D2,7 x H68 W37.60" x D1.06" x H26.77"	1 pcs. W95.5 x D2.7 x H68   12 kg	1 box   1 pcs.	3.400,00

## STEEL SLIDING DOOR PREPARED FOR LOCK DOUBLE HEIGHT | 100

Powder coated steel. Incl. handle in extruded powder coated aluminium. 1 sliding door opening right. Adjustable screw in the bottom to make sure you get the best fit. Prepared for Häfele Symo Universal HS 3 locking system, Type 0601-0700. The lock cylinder is packed separately. To be mounted by customer. Master key 210.113 is an option. Please specify the number of the lock cylinder and the key between 0601-700.

Order produced

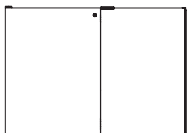

MATERIAL	COLOUR		
	Army	Charcoal	Light grey
Powder coated steel	•	•	•

VARIANT	DIMENSION	BOX DIMENSION   WEIGHT	PACKAGING	PRICE
W100	W100 x D1 x H68 W39.37" x D0.39" x H26.77"	1 pcs. W100 x D1 x H68   12 kg	1 box   1 pcs.	4.200,00

### ADD-ON FOR LOCK

Lock cylinder - keys not incl. 210.41.603	W2,5 x D1,5 x H1,5 W0.98" x D0.59" x H0.59"	1 pcs. W5 x D2 x H2   0.1 kg	1 box   1 pcs.	+ 150,00
Extra Key for lock cylinder 210.11.058	W2,5 x D1,5 x H0,2 W0.98" x D0.59" x H0.08"	1 pcs. W4 x D1 x H1   0.02 kg	1 box   1 pcs.	+ 119,00

# 24% rabatt ska dras av på angivna priser

## STEEL SLIDING DOOR PREPARED FOR LOCK DOUBLE HEIGHT | 100 LEFT

Powder coated steel. Incl. handle in extruded powder coated aluminium. 1 sliding door opening left. Adjustable screw in the bottom to make sure you get the best fit. Prepared for Häfele Symo Universal HS 3 locking system, Type 0601-0700. The lock cylinder is packed separately. To be mounted by customer. Master key 210.113 is an option. Please specify the number of the lock cylinder and the key between 0601-700.

Order produced

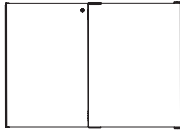

MATERIAL	COLOUR		
	Army	Charcoal	Light grey
Powder coated steel	•	•	•

VARIANT	DIMENSION	BOX DIMENSION   WEIGHT	PACKAGING	PRICE
W100	W100 x D1 x H68 W39.37" x D0.39" x H26.77"	1 pcs. W100 x D1 x H68   12 kg	1 box   1 pcs.	4.200,00
<b>ADD-ON FOR LOCK</b>				
Lock cylinder - keys not incl. 210.41.603	W2,5 x D1,5 x H1,5 W0.98" x D0.59" x H0.59"	1 pcs. W5 x D2 x H2   0.1 kg	1 box   1 pcs.	+ 150,00
Extra Key for lock cylinder 210.11.058	W2,5 x D1,5 x H0,2 W0.98" x D0.59" x H0.08"	1 pcs. W4 x D1 x H1   0.02 kg	1 box   1 pcs.	+ 119,00

# 24% rabatt ska dras av på angivna priser

## HIGH DRAWER INCL. MOUNTING SET | 34 | SET OF 1 OR DOUBLE HEIGHT | SET OF 2

Powder coated steel. It is possible to post mount lock bar or middle bar on double height drawers set of 2. Set of 2 drawers is used with double height profiles. Set of 1 drawer is used with single height profiles. Please note that all shelving units with drawers require wall- or floor safety brackets. Max load 15 kg. pr. drawer.

Order produced

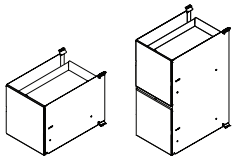

MATERIAL	COLOUR		
	Army	Charcoal	Light grey
Powder coated steel	•	•	•

VARIANT	DIMENSION	BOX DIMENSION   WEIGHT	PACKAGING	PRICE
H33	W34 x D48 x H33 cm W13.39" x D18.90" x H12.99"		1 box   1 pcs.	6.440,00
H68	W34 x D48 x H68 cm W13.39" x D18.90" x H26.77"		1 box   1 pcs.	12.060,00

## HIGH DRAWER INCL. MOUNTING SET100 | SET OF 1 OR DOUBLE HEIGHT | SET OF 2

Powder coated steel. It is possible to post mount lock bar or middle bar on double height drawers set of 2. Set of 2 drawers is used with double height profiles. Set of 1 drawer is used with single height profiles. Please note that all shelving units with drawers require wall- or floor safety brackets. Max load 15 kg. pr. drawer.

Order produced

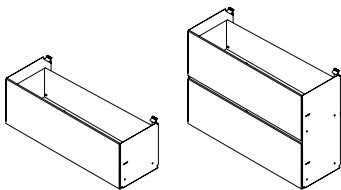

MATERIAL	COLOUR		
	Army	Charcoal	Light grey
Powder coated steel	•	•	•

VARIANT	DIMENSION	BOX DIMENSION   WEIGHT	PACKAGING	PRICE
H33	W100 x D34 x H33 cm W39.37" x D13.36" x H12.99"		1 box   1 pcs.	7.210,00
H68	W100 x D34 x H68 cm W39.37" x D13.36" x H26.77"		1 box   1 pcs.	14.400,00



# 24% rabatt ska dras av på angivna priser

## DRAWER INCL. MOUNTING SET 34 | SET OF 2 OR DOUBLE HEIGHT | SET OF 4

Powder coated steel. It is possible to post mount lock bar or middle bar. Set of 2 drawers is used with single height profiles. Set of 4 drawers is used with double height profiles. Please note that all shelving units with drawers require wall- or floor safety brackets. Max load 15 kg. pr. drawer.

Order produced

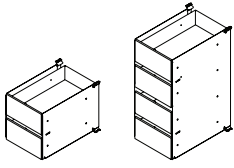

MATERIAL	COLOUR
Powder coated steel	Army Charcoal Light grey

VARIANT	DIMENSION	BOX DIMENSION   WEIGHT	PACKAGING	PRICE
H33	W34 x D48 x H33 cm W13.39" x D18.90" x H12.99"		1 box   1 pcs.	9.700,00
H68	W34 x D48 x H68 cm W13.39" x D18.90" x H26.77"		1 box   1 pcs.	19.100,00

## DRAWER INCL. MOUNTING SET 100 | SET OF 2 OR DOUBLE HEIGHT | SET OF 4

Powder coated steel. It is possible to post mount lock bar or middle bar. Set of 2 drawers is used with single height profiles. Set of 4 drawers is used with double height profiles. Please note that all shelving units with drawers require wall- or floor safety brackets. Max load 15 kg. pr. drawer.

Order produced

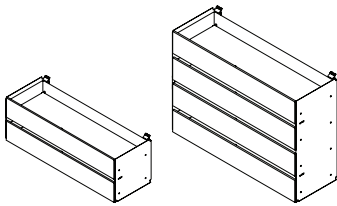

MATERIAL	COLOUR
Powder coated steel	Army Charcoal Light grey

VARIANT	DIMENSION	BOX DIMENSION   WEIGHT	PACKAGING	PRICE
H33	W100 x D34 x H33 cm W39.37" x D13.36" x H12.99"		1 box   1 pcs.	11.300,00
H68	W100 x D34 x H68 cm W39.37" x D13.36" x H26.77"		1 box   1 pcs.	22.300,00

## MIDDLE BAR FOR DRAWER | 34 | 100

Powder coated steel. Can be used to close the gap between two drawers. To be mounted by customer.

Order produced



MATERIAL	COLOUR
Powder coated steel	Army Charcoal Light grey

VARIANT	DIMENSION	BOX DIMENSION   WEIGHT	PACKAGING	PRICE
W34	W29,5 x D6,8 x H2,6 W11.61" x D2.68" x H1.02"	1 pcs. W29.5 x D6.8 x H2.6   1 kg	1 box   1 pcs.	790,00
W100	W95,5 x D6,8 x H2,6 W37.60" x D2.68" x H1.02"	1 pcs. W95.5 x D6.8 x H2.6   2.5 kg	1 box   1 pcs.	1.000,00

# 24% rabatt ska dras av på angivna priser

## LOCK BAR DRAWER PREPARED FOR LOCK 34 | 100

Powder coated steel. Can be used to close the gap between two drawers. Please note for set of 4 drawers only 2 lock bars and 1 middle bar. Prepared for Häfele Symo Universal HS 3 locking system, Type 0601-0700. The lock cylinder is packed separately. To be mounted by customer. Master key 210.113 is an option. Please specify the number of the lock cylinder and the key between 0601-700.

Order produced



MATERIAL	COLOUR		
	Army	Charcoal	Light grey
Powder coated steel	•	•	•

VARIANT	DIMENSION	BOX DIMENSION   WEIGHT	PACKAGING	PRICE
W34	W29,5 x D6,8 x H2,6 W11.61" x D2.68" x H1.02"	1 pcs. W29.5 x D6.8 x H2.6   1 kg	1 box   1 pcs.	1.250,00
W100	W95,5 x D6,8 x H2,6 W37.60" x D2.68" x H1.02"	1 pcs. W95.5 x D6.8 x H2.6   2.5 kg	1 box   1 pcs.	1.500,00
<b>ADD-ON FOR LOCK</b>				
Lock cylinder - keys not incl. 210.41.603	W2,5 x D1,5 x H1,5 W0.98" x D0.59" x H0.59"	1 pcs. W5 x D2 x H2   0.1 kg	1 box   1 pcs.	+ 150,00  + 119,00

## EXTRA LOCK CYLINDER

Lock cylinder core for left or right hand use. Nickel plated zinc alloy housing, brass plate levers. Standard locking system - Häfele Symo Universal HS 3, Type 0601-0700. Häfele item no. 210.41.603. Please specify the number of the lock cylinder and the key between 0601-700. Master key is an option.

Order produced



VARIANT	DIMENSION	BOX DIMENSION   WEIGHT	PACKAGING	PRICE
EXTRA LOCK CYLINDER	W2,5 x D1,5 x H1,5 W0.98" x D0.59" x H0.59"	1 pcs. W5 x D2 x H2   0.1 kg	1 box   1 pcs.	150,00

## EXTRA KEY FOR LOCK CYLINDER

Key for lock cylinder. Nickel-plated steel. Standard locking system - Häfele Symo Universal HS 3, Type 0601-0700. Häfele item no 210.11.058. Please specify the number of the lock cylinder and the key between 0601-700. Master key is an option.

Order produced



VARIANT	DIMENSION	BOX DIMENSION   WEIGHT	PACKAGING	PRICE
EXTRA KEY FOR LOCK CYLINDER	W2,5 x D1,5 x H0,2 W0.98" x D0.59" x H0.08"	1 pcs. W4 x D1 x H1   0.02 kg	1 box   1 pcs.	119,00

# 24% rabatt ska dras av på angivna priser

## MASTER KEY

Master key for Symo Universal cylinder core SYMO 3000-, HS3. Nickel plated steel. Häfele item no. 210.11.003

Order produced



VARIANT	DIMENSION	BOX DIMENSION   WEIGHT	PACKAGING	PRICE
MASTER KEY	W2,5 x D1,5 x H0,2 W0.98" x D0.59" x H0.08"	1 pcs. W0 x D0 x H0   0 kg	1 box   1 pcs.	150,00

## EXCHANGE KEY FOR LOCK CYLINDER

Exchange key for removing the lock cylinder. Nickel plated steel. Häfele item no. 210.11.090

Order produced

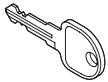

VARIANT	DIMENSION	BOX DIMENSION   WEIGHT	PACKAGING	PRICE
EXCHANGE KEY FOR LOCK CYLINDER	W2,5 x D1,5 x H0,2 W0.98" x D0.59" x H0.08"	1 pcs. W4 x D1 x H1   0.02 kg	1 box   1 pcs.	250,00

# 24% rabatt ska dras av på angivna priser

## WALL BRACKET SHELF | SET OF 2

### WALL BRACKET FOR DOUBLE HEIGHT SHELF | SET OF 2

Shelf bottom requires shelf wall bracket. Available for wooden- and steel wall panels.

Stock item

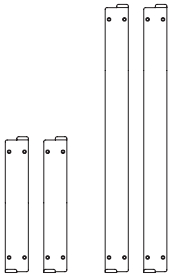

MATERIAL	COLOUR		
	Army	Charcoal	Light grey
Powder coated steel	•	•	•

VARIANT	DIMENSION	BOX DIMENSION   WEIGHT	PACKAGING	PRICE
H36	W6 x D2,5 x H36 W2.36" x D0.98" x H14.17"	1 pcs. W44 x D6 x H2,5   1.70 kg	1 box   1 pcs.	250,00
H71	W6 x D2,5 x H71 cm W2.36" x D0.98" x H27.95"	1 pcs. W79 x D6 x H2,5   3.30 kg	1 box   1 pcs.	500,00

## WALL SAFETY BRACKETS FOR SHELVING SYSTEM | SET OF 2

Powder coated steel and aluminium. Works with both shelf and tray. Can be used together with wooden wall panels or steel wall panels. Please follow the guidelines in our instruction manuals. It does not work with textile panels. wall screws and plugs are not incl. Max. 40 mm from the wall.

Stock item

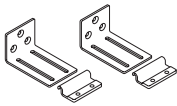

MATERIAL	COLOUR		
	Army	Charcoal	Light grey
Powder coated steel	•	•	•

VARIANT	DIMENSION	BOX DIMENSION   WEIGHT	PACKAGING	PRICE
	W4 x D5,5 x H5 W1.57" x D2.17" x H1.97"	1 pcs. W4 x D5.5 x H5   12 kg	1 box   1 pcs.	250,00

## FLOOR SAFETY BRACKETS FOR SHELVING SYSTEM | SET OF 2

Powder coated steel. Works with both shelf and tray. Please follow the guidelines in our instruction manuals. Floor screws and plugs are not incl.

Stock item

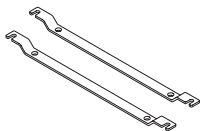

MATERIAL	COLOUR		
	Army	Charcoal	Light grey
Powder coated steel	•	•	•

VARIANT	DIMENSION	BOX DIMENSION   WEIGHT	PACKAGING	PRICE
	W40 x D2 x H3 W15.75" x D0.79" x H1.18"	1 pcs. W40 x D2 x H3   0.7 kg	1 box   1 pcs.	500,00

# 24% rabatt ska dras av på angivna priser

## REPAIR KIT

Laquer  
Sales QTY.: min. 10 pcs. mix

Stock item



MATERIAL	COLOUR		
	Army	Charcoal	Light grey
Laquer	•	•	•

VARIANT	DIMENSION	BOX DIMENSION   WEIGHT	PACKAGING	PRICE
	W2 x D2 x H6,5 W0.79" x D0.79" x H2.56"	1 pcs. W2 x D2 x H6.5   0.1 kg	1 box   1 pcs.	150,00

## WHEELS | SET OF 4

Ø55 mm. Max. height with wheels is 2 layers - 1 bottom and 1 top. Can be mounted on both shelf and tray bottom.  
Set of 4 (2 wheels with brake and 2 wheels without).

Stock item

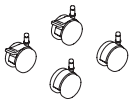

MATERIAL	COLOUR	
	Black	
Plastic	•	

VARIANT	DIMENSION	BOX DIMENSION   WEIGHT	PACKAGING	PRICE
	W5,5 x D5,5 x H3,6 W2.17" x D2.17" x H1.42"	1 pcs. W18.5 x D16 x H4.5   0.4 kg	1 box   1 pcs.	500,00

## SHELF BOOK DIVIDER | LEFT OR RIGHT

Book dividers in powder coated steel.

Stock item

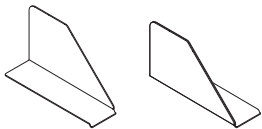

MATERIAL	COLOUR		
	Army	Charcoal	Light grey
Powder coated steel	•	•	•

VARIANT	DIMENSION	BOX DIMENSION   WEIGHT	PACKAGING	PRICE
LEFT	W14 x D9 x H31,3 W5.51" x D3.54" x H12.32"	1 pcs. W35 x D20 x H10   0.7 kg	1 box   1 pcs.	400,00
RIGHT	W14 x D9 x H31,3 W5.51" x D3.54" x H12.32"	1 pcs. W35 x D20 x H10   0.7 kg	1 box   1 pcs.	400,00

# 24% rabatt ska dras av på angivna priser

## TROLLEY A | 1 DRAWER & TRAY TOP

Trolley in powder coated steel, die cast extruded aluminium. Incl. 4 x Ø55 mm wheels, 2 with brake.  
Incl. Standard locking system - Häfele Symo Universal HS, unsorted numbers.

Stock item

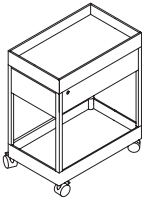

MATERIAL	COLOUR		
	Army	Charcoal	Light grey
Powder coated steel	•	•	•

VARIANT	DIMENSION	BOX DIMENSION   WEIGHT	PACKAGING	PRICE
TROLLEY A	W34 x D55 x H67,5 W13.39" x D21.65" x H26.57"	1 pcs. W45 x D66 x H78   20 kg	1 box   1 pcs.	8.600,00

## TROLLEY B | 3 DRAWER & TRAY TOP

Trolley in powder coated steel, die cast extruded aluminium. Incl. 4 x Ø55 mm wheels, 2 with brake.  
Incl. Standard locking system - Häfele Symo Universal HS, unsorted numbers.

Stock item

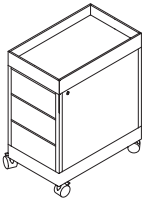

MATERIAL	COLOUR		
	Army	Charcoal	Light grey
Powder coated steel	•	•	•

VARIANT	DIMENSION	BOX DIMENSION   WEIGHT	PACKAGING	PRICE
TROLLEY B	W34 x D55 x H67,5 W13.39" x D21.65" x H26.57"	1 pcs. W45 x D66 x H78   27 kg	1 box   1 pcs.	11.750,00

# 24% rabatt ska dras av på angivna priser

## TABLE | 4 LEGS

12 mm tabletop in MDF with linoleum or 10 mm tabletop in MDF with veneer.  
Tabletop is placed inside the table frame. 4 legs incl. adjustable gliders.  
Requires assembly.

Order produced

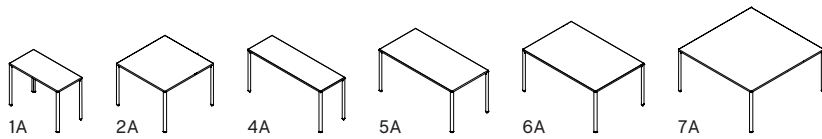

FRAME & LEGS	TABLETOP			
	Army powder coated aluminium	Cloud grey linoleum	Dark grey linoleum	Green linoleum
Charcoal powder coated aluminium	•	•	•	•
Light grey powder coated aluminium	•	•	•	•

VARIANT	DIMENSION	BOX DIMENSION   WEIGHT	PACKAGING	PRICE
1A	L100 x W50 x H74 cm L39.37" x W19.69" x 29.13"	W163 x D42 x H7,5 cm   7,0 kg W120 x D70 x H2,5 cm   7,3 kg W75 x D27 x H8 cm   11 kg	3 box   1 pcs.	12.180,00
2A	L100 x W100 x H74 cm L39.37" x W39.37" x 29.13"	W160 x D42 x H16 cm   12 kg W120 x D120 x H2,5 cm   12,9 kg W75 x D27 x H8 cm   11 kg	3 box   1 pcs.	14.250,00
4A	L150 x W50 x H74 cm L59.06 x W19.69 x 29.13"	W42 x D163 x H15,5 cm   8,5 kg W163,5 x D63,5 x H2,5 cm   9,8 kg W75 x D27 x H8 cm   11 kg	3 box   1 pcs.	15.500,00
5A	L150 x W75 x H74 cm L59.06 x W29.53 x 29.13"	W160 x D42 x H16 cm   9 kg W163,5 x D88,5 x H2,5 cm   14,6 kg W75 x D27 x H8 cm   11 kg	3 box   1 pcs.	16.900,00
6A	L150 x W100 x H74 cm L59.06 x W39.37" x 29.13"	W160 x D42 x H16 cm   14 kg W163,5 x D113,5 x H2,5 cm   19,3 kg W75 x D27 x H8 cm   11 kg	3 box   1 pcs.	16.750,00
7A	L150 x W150 x H74 cm L59.06 x W59.06 x 29.13"	W160 x D42 x H16 cm   18 kg W163,5 x D163,5 x H2,5 cm   28,7 kg W75 x D27 x H8 cm   11 kg	3 box   1 pcs.	19.700,00

## TABLE | 4 LEGS

12 mm tabletop in MDF with linoleum or 10 mm tabletop in MDF with veneer.  
Tabletop is placed inside the table frame. 4 legs incl. adjustable gliders.  
Requires assembly.

Order produced

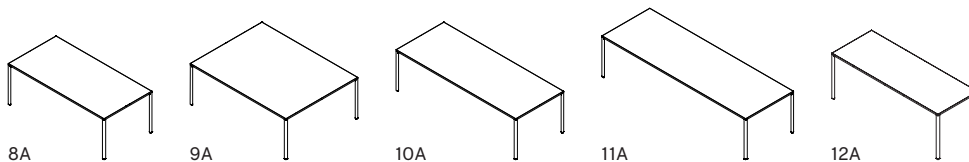

FRAME & LEGS	TABLETOP			
	Army powder coated aluminium	Cloud grey linoleum	Dark grey linoleum	Green linoleum
Charcoal powder coated aluminium	•	•	•	•
Light grey powder coated aluminium	•	•	•	•

VARIANT	DIMENSION	BOX DIMENSION   WEIGHT	PACKAGING	PRICE
8A	L200 x W100 x H74 cm L78.74" x W39.37" x 29.13"	W210 x D42 x H16 cm   18 kg W214 x D114 x H4,5 cm   32 kg W75 x D27 x H8 cm   6 kg	3 box   1 pcs.	19.550,00
9A	L200 x W75 x H74 cm L78.74" x W29.53" x 29.13"	W210 x D42 x H16 cm   16 kg W213,5 x D88,5 x H2,5 cm   19,1kg W79 x D27 x H8 cm   11 kg	3 box   1 pcs.	22.500,00
10A	L250 x W100 x H74 cm L78.74" x W39.37" x 29.13"	W252 x D42 x H16 cm   22 kg W264 x D114 x H4,5 cm   38 kg W75 x D27 x H8 cm   11 kg	3 box   1 pcs.	25.950,00
11A	L300 x W100 x H74 cm L98.43" x W39.37" x 29.13"	W320 x D20 x H14,5 cm   20 kg W314 x D114 x H4,5 cm   41 kg W75 x D27 x H8 cm   6 kg	3 box   1 pcs.	27.850,00
12A	L200 x W75 x H74 cm L78.74" x W29.53" x 29.13"	W210 x D42 x H16 cm   16 kg W213,5 x D88,5 x H2,5 cm   19,1kg W79 x D27 x H8 cm   11 kg	3 box   1 pcs.	19.250,00

# 24% rabatt ska dras av på angivna priser

## TABLE INCL. SINGLE PLUG & PLAY | 4 LEGS

12 mm tabletop in MDF with linoleum or 10 mm tabletop in MDF with veneer. Incl. 2 x Single Plug & Play Center. Tabletop is placed inside the table frame. 4 legs incl. adjustable gliders. Requires assembly. STEP modules not included.

Order produced

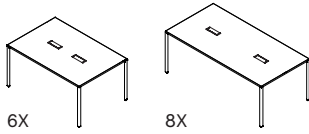

FRAME & LEGS		TABLETOP			
Army powder coated aluminium		Cloud grey linoleum	Dark grey linoleum	Green linoleum	Grey linoleum
Charcoal powder coated aluminium					
Light grey powder coated aluminium					

VARIANT	DIMENSION	BOX DIMENSION   WEIGHT	PACKAGING	PRICE
6X	L150 x W100 x H74 cm L59,06 x W39.37" x 29.13"	W160 x D42 x H16 cm   14 kg W163,5 x D113,5 x H2,5 cm   19,3 kg W75 x D27 x H8 cm   11 kg	3 box   1 pcs.	23.000,00
8X	L200 x W100 x H74 cm L78.74" x W39.37" x 29.13"	W210 x D42 x H16 cm   18 kg W214 x D114 x H4,5 cm   32 kg W75 x D27 x H8 cm   6 kg	3 box   1 pcs.	26.900,00

## TABLE INCL. CABLE MANAGEMENT EDGE | 4 LEGS

12 mm tabletop in MDF with linoleum or 10 mm tabletop in MDF with veneer. Incl. 40 mm cable management cover. Tabletop is placed inside the table frame. 4 legs incl. adjustable gliders. Requires assembly. STEP modules not included.

Order produced

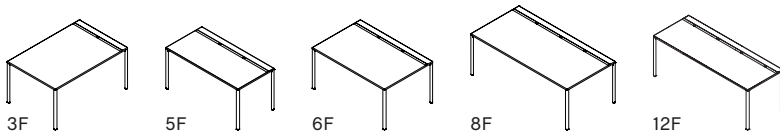

FRAME & LEGS		TABLETOP			
Army powder coated aluminium		Cloud grey linoleum	Dark grey linoleum	Green linoleum	Grey linoleum
Charcoal powder coated aluminium					
Light grey powder coated aluminium					

VARIANT	DIMENSION	BOX DIMENSION   WEIGHT	PACKAGING	PRICE
3F	L100 x W50 x H74 cm L39.37" x W19.69" x 29.13"	W160 x D42 x H16 cm   14 kg W164 x D114 x H4,5 cm   26 kg W75 x D27 x H8 cm   6 kg	3 box   1 pcs.	19.400,00
5F	L150 x W75 x H74 cm L59.06 x W29.53 x 29.13"	W160 x D42 x H16 cm   17 kg W75 x D27 x H8 cm   11 kg W164 x D89 x H4,5 cm   27 kg	3 box   1 pcs.	21.600,00
6F	L150 x W100 x H74 cm L59,06 x W39.37" x 29.13"	W160 x D42 x H16 cm   16 kg W75 x D27 x H8 cm   11 kg W164 x D114 x H4,5 cm   26 kg	3 box   1 pcs.	21.450,00
8F	L200 x W100 x H74 cm L78.74" x W39.37" x 29.13"	W202 x D42 x H14,5 cm   16 kg W75 x D27 x H8 cm   6 kg W214 x D114 x H4,5 cm   32 kg	3 box   1 pcs.	21.400,00
12F	L200 x W75 x H74 cm L78.74" x W29.53 x 29.13"	W210 x D42 x H16 cm   16 kg W213,5 x D88,5 x H2,5 cm   19,1kg W79 x D27 x H8 cm   11 kg	3 box   1 pcs.	25.000,00



# 24% rabatt ska dras av på angivna priser

## TABLE INCL. PLUG & PLAY CABLE MANAGEMENT EDGE | 4 LEGS

12 mm tabletop in MDF with linoleum or 10 mm tabletop in MDF with veneer. Incl. 80 mm plug & play cable management cover. Tabletop is placed inside the table frame. 4 legs incl. adjustable gliders. Requires assembly. STEP modules not included.

Order produced

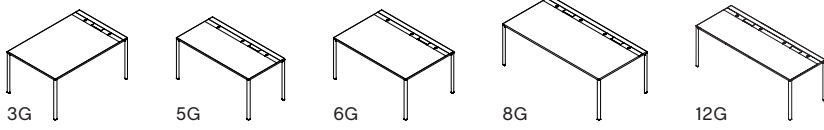

FRAME & LEGS	TABLETOP			
	Cloud grey linoleum	Dark grey linoleum	Green linoleum	Grey linoleum
Army powder coated aluminium	•	•	•	•
Charcoal powder coated aluminium	•	•	•	•
Light grey powder coated aluminium	•	•	•	•

VARIANT	DIMENSION	BOX DIMENSION   WEIGHT	PACKAGING	PRICE
3G	L100 x W50 x H74 cm L39.37" x W19.69" x 29.13"	W160 x D42 x H16 cm   14 kg W164 x D114 x H4,5 cm   26 kg W75 x D27 x H8 cm   6 kg	3 box   1 pcs.	21.450,00
5G	L150 x W75 x H74 cm L59.06" x W29.53" x 29.13"	W160 x D42 x H16 cm   17 kg W75 x D27 x H8 cm   11 kg W164 x D89 x H4,5 cm   27 kg	3 box   1 pcs.	23.150,00
6G	L150 x W100 x H74 cm L59.06" x W39.37" x 29.13"	W160 x D42 x H16 cm   16 kg W75 x D27 x H8 cm   11 kg W164 x D114 x H4,5 cm   26 kg	3 box   1 pcs.	23.000,00
8G	L200 x W100 x H74 cm L78.74" x W39.37" x 29.13"	W202 x D42 x H14,5 cm   16 kg W75 x D27 x H8 cm   6 kg W214 x D114 x H4,5 cm   32 kg	3 box   1 pcs.	26.900,00
12G	L200 x W75 x H74 cm L78.74" x W29.53" x 29.13"	W210 x D42 x H16 cm   16 kg W213,5 x D88,5 x H2,5 cm   19,1kg W79 x D27 x H8 cm   11 kg	3 box   1 pcs.	26.600,00

## TABLE INCL. CABLE MANAGEMENT EDGE 34 CM | 4 LEGS

12 mm tabletop in MDF with linoleum or 10 mm tabletop in MDF with veneer. Incl. 40 mm cable management cover. Tabletop is placed inside the table frame. 4 legs incl. adjustable gliders. Requires assembly. STEP modules not included.

Order produced

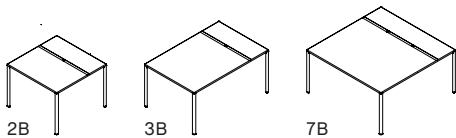

FRAME & LEGS	TABLETOP			
	Cloud grey linoleum	Dark grey linoleum	Green linoleum	Grey linoleum
Army powder coated aluminium	•	•	•	•
Charcoal powder coated aluminium	•	•	•	•
Light grey powder coated aluminium	•	•	•	•

VARIANT	DIMENSION	BOX DIMENSION   WEIGHT	PACKAGING	PRICE
2B	L100 x W100 x H74 cm L39.37" x W39.37" x 29.13"	W160 x D42 x H16 cm   12 kg W114 x D114 x H4,5 cm   22 kg W75 x D27 x H8 cm   11 kg	3 box   1 pcs.	17.650,00
3B	L100 x W150 x H74 cm L39.37" x W59.06" x 29.13"	W160 x D42 x H16 cm   14 kg W164 x D114 x H4,5 cm   26 kg W75 x D27 x H8 cm   6 kg	3 box   1 pcs.	19.400,00
7B	L150 x W150 x H74 cm L59.06 x W59.06 x 29.13"	W160 x D42 x H16 cm   21 kg W164 x D89 x H9 cm   48 kg W75 x D27 x H8 cm   11 kg	3 box   1 pcs.	21.600,00

# 24% rabatt ska dras av på angivna priser

## TABLE INCL. PLUG & PLAY CABLE MANAGEMENT EDGE 34 CM | 4 LEGS

12 mm tabletop in MDF with linoleum or 10 mm tabletop in MDF with veneer. Incl. 80 mm plug & play cable management cover. Tabletop is placed inside the table frame. 4 legs incl. adjustable gliders. Requires assembly. STEP modules not included.

Order produced

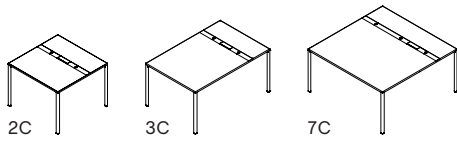

FRAME & LEGS	TABLETOP			
	Army powder coated aluminium	Cloud grey linoleum	Dark grey linoleum	Green linoleum
Charcoal powder coated aluminium	•	•	•	•
Light grey powder coated aluminium	•	•	•	•

VARIANT	DIMENSION	BOX DIMENSION   WEIGHT	PACKAGING	PRICE
2C	L100 x W100 x H74 cm L39.37" x W39.37" x 29.13"	W160 x D42 x H16 cm   12 kg W114 x D114 x H4,5 cm   22 kg W75 x D27 x H8 cm   11 kg	3 box   1 pcs.	18.950,00
3C	L100 x W150 x H74 cm L39.37" x W59.06" x 29.13"	W160 x D42 x H16 cm   14 kg W164 x D114 x H4,5 cm   26 kg W75 x D27 x H8 cm   6 kg	3 box   1 pcs.	21.450,00
7C	L150 x W150 x H74 cm L59.06 x W59.06 x 29.13"	W160 x D42 x H16 cm   21 kg W164 x D89 x H9 cm   48 kg W75 x D27 x H8 cm   11 kg	3 box   1 pcs.	26.300,00

## TABLE INCL. CABLE MANAGEMENT EDGE 34 CM | PREPARED FOR TOP TRAY DIVIDER | 4 LEGS

12 mm tabletop in MDF with linoleum or 10 mm tabletop in MDF with veneer. Incl. 40 mm cable management cover prepared for top divider edge. Tabletop is placed inside the table frame. 4 legs incl. adjustable gliders. Requires assembly. STEP modules, top tray and single profiles not included.

Order produced

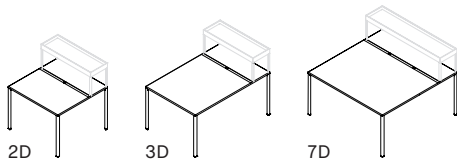

FRAME & LEGS	TABLETOP			
	Army powder coated aluminium	Cloud grey linoleum	Dark grey linoleum	Green linoleum
Charcoal powder coated aluminium	•	•	•	•
Light grey powder coated aluminium	•	•	•	•

VARIANT	DIMENSION	BOX DIMENSION   WEIGHT	PACKAGING	PRICE
2D	L100 x W100 x H74 cm L39.37" x W39.37" x 29.13"	W160 x D42 x H16 cm   12 kg W114 x D114 x H4,5 cm   22 kg W75 x D27 x H8 cm   11 kg	3 box   1 pcs.	18.400,00
3D	L100 x W150 x H74 cm L39.37" x W59.06" x 29.13"	W160 x D42 x H16 cm   14 kg W164 x D114 x H4,5 cm   26 kg W75 x D27 x H8 cm   6 kg	3 box   1 pcs.	20.200,00
7D	L150 x W150 x H74 cm L59.06 x W59.06 x 29.13"	W160 x D42 x H16 cm   21 kg W164 x D89 x H9 cm   48 kg W75 x D27 x H8 cm   11 kg	3 box   1 pcs.	22.400,00

# 24% rabatt ska dras av på angivna priser

## TABLE INCL. PLUG & PLAY CABLE MANAGEMENT EDGE 34 CM | PREPARED FOR TOP TRAY DIVIDER | 4 LEGS

12 mm tabletop in MDF with linoleum or 10 mm tabletop in MDF with veneer. Incl. 80 mm plug & play cable management cover prepared for top divider edge. Tabletop is placed inside the table frame. 4 legs incl. adjustable gliders. Requires assembly. STEP modules, top tray and single profiles not included.

Order produced

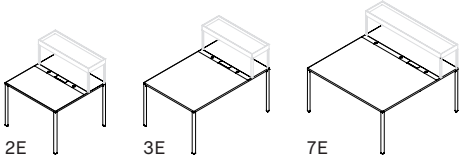

FRAME & LEGS		TABLETOP			
Army powder coated aluminium		Cloud grey linoleum			
Charcoal powder coated aluminium		Dark grey linoleum			
Light grey powder coated aluminium		Green linoleum			
		Grey linoleum			
		Water-based lacquered oak veneer			

VARIANT	DIMENSION	BOX DIMENSION   WEIGHT	PACKAGING	PRICE
2E	L100 x W100 x H74 cm L39.37" x W39.37" x 29.13"	W160 x D42 x H16 cm   12 kg W114 x D114 x H4,5 cm   22 kg W75 x D27 x H8 cm   11 kg	3 box   1 pcs.	19.700,00
3E	L100 x W150 x H74 cm L39.37" x W59.06" x 29.13"	W160 x D42 x H16 cm   14 kg W164 x D114 x H4,5 cm   26 kg W75 x D27 x H8 cm   6 kg	3 box   1 pcs.	22.200,00
7E	L150 x W150 x H74 cm L59.06 x W59.06 x 29.13"	W160 x D42 x H16 cm   21 kg W164 x D89 x H9 cm   48 kg W75 x D27 x H8 cm   11 kg	3 box   1 pcs.	27.100,00

## TABLE INCL. CABLE MANAGEMENT | PREPARED FOR TOP TRAY DIVIDER AND TABLE SCREENS EDGE | 4 LEGS

12 mm tabletop in MDF with linoleum or 10 mm tabletop in MDF with veneer. Incl. 40 mm cable management cover and prepared for top divider and table screens edge. Tabletop is placed inside the table frame. 4 legs incl. adjustable gliders. Requires assembly. Table screens, STEP modules, top tray and single profiles not included.

Order produced

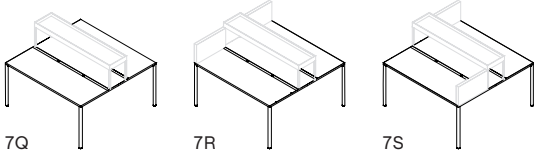

FRAME & LEGS		TABLETOP			
Army powder coated aluminium		Cloud grey linoleum			
Charcoal powder coated aluminium		Dark grey linoleum			
Light grey powder coated aluminium		Green linoleum			
		Grey linoleum			
		Water-based lacquered oak veneer			

VARIANT	DIMENSION	BOX DIMENSION   WEIGHT	PACKAGING	PRICE
7Q	L150 x W150 x H74 cm L59.06 x W59.06 x 29.13"	W160 x D42 x H16 cm   21 kg W164 x D89 x H9 cm   48 kg W75 x D27 x H8 cm   11 kg	3 box   1 pcs.	25.700,00
7R	L150 x W150 x H74 cm L59.06 x W59.06 x 29.13"	W160 x D42 x H16 cm   21 kg W164 x D89 x H9 cm   48 kg W75 x D27 x H8 cm   11 kg	3 box   1 pcs.	28.000,00
7S	L150 x W150 x H74 cm L59.06 x W59.06 x 29.13"	W160 x D42 x H16 cm   21 kg W164 x D89 x H9 cm   48 kg W75 x D27 x H8 cm   11 kg	3 box   1 pcs.	28.000,00

# 24% rabatt ska dras av på angivna priser

## TABLE INCL. PLUG & PLAY CABLE MANAGEMENT | PREPARED FOR TOP TRAY DIVIDER AND TABLE SCREENS EDGE | 4 LEGS

12 mm tabletop in MDF with linoleum or 10 mm tabletop in MDF with veneer. Incl. 80 mm plug & play cable management cover and prepared for top divider and table screens edge. Tabletop is placed inside the table frame. 4 legs incl. adjustable gliders. Requires assembly. Table screens, STEP modules, top tray and single profiles not included.

Order produced

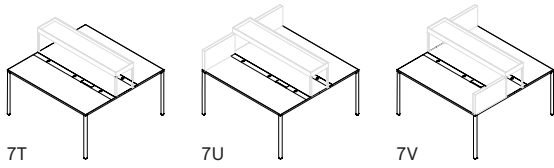

FRAME & LEGS		TABLETOP				
Army powder coated aluminium		Cloud grey linoleum				
Charcoal powder coated aluminium		Dark grey linoleum				
Light grey powder coated aluminium		Green linoleum				
		Grey linoleum				
		Water-based lacquered oak veneer				

VARIANT	DIMENSION	BOX DIMENSION   WEIGHT	PACKAGING	PRICE
7T	L150 x W150 x H74 cm L59.06 x W59.06 x 29.13"	W160 x D42 x H16 cm   21 kg W164 x D89 x H9 cm   48 kg W75 x D27 x H8 cm   11 kg	3 box   1 pcs.	27.250,00
7U	L150 x W150 x H74 cm L59.06 x W59.06 x 29.13"	W160 x D42 x H16 cm   21 kg W164 x D89 x H9 cm   48 kg W75 x D27 x H8 cm   11 kg	3 box   1 pcs.	29.550,00
7V	L150 x W150 x H74 cm L59.06 x W59.06 x 29.13"	W160 x D42 x H16 cm   21 kg W164 x D89 x H9 cm   48 kg W75 x D27 x H8 cm   11 kg	3 box   1 pcs.	29.550,00

## TABLE INCL. CABLE MANAGEMENT CENTER OR PREPARED FOR TABLE SCREENS | 4 LEGS

12 mm tabletop in MDF with linoleum or 10 mm tabletop in MDF with veneer. Incl. 40 mm cable management cover or prepared for table screens. Tabletop is placed inside the table frame. 4 legs incl. adjustable gliders. Requires assembly. Table screens and STEP modules not included.

Order produced

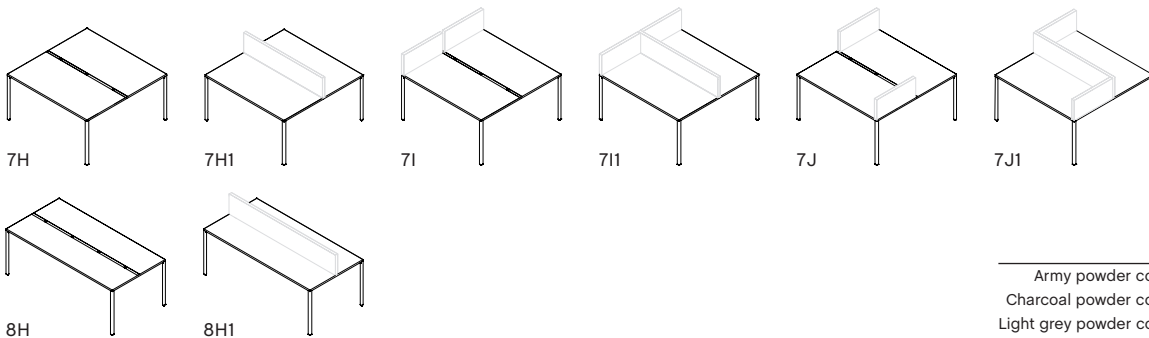

FRAME & LEGS		TABLETOP				
Army powder coated aluminium		Cloud grey linoleum				
Charcoal powder coated aluminium		Dark grey linoleum				
Light grey powder coated aluminium		Green linoleum				
		Grey linoleum				
		Water-based lacquered oak veneer				

VARIANT	DIMENSION	BOX DIMENSION   WEIGHT	PACKAGING	PRICE
7H	L150 x W150 x H74 cm L59.06 x W59.06 x 29.13"	W160 x D42 x H16 cm   21 kg W164 x D89 x H9 cm   48 kg W75 x D27 x H8 cm   11 kg	3 box   1 pcs.	21.600,00
7H1	L150 x W150 x H74 cm L59.06 x W59.06 x 29.13"	W160 x D42 x H16 cm   21 kg W164 x D89 x H9 cm   48 kg W75 x D27 x H8 cm   11 kg	3 box   1 pcs.	21.600,00
7I	L150 x W150 x H74 cm L59.06 x W59.06 x 29.13"	W160 x D42 x H16 cm   21 kg W164 x D89 x H9 cm   48 kg W75 x D27 x H8 cm   11 kg	3 box   1 pcs.	27.100,00
7I1	L150 x W150 x H74 cm L59.06 x W59.06 x 29.13"	W160 x D42 x H16 cm   21 kg W164 x D89 x H9 cm   48 kg W75 x D27 x H8 cm   11 kg	3 box   1 pcs.	27.100,00
7J	L150 x W150 x H74 cm L59.06 x W59.06 x 29.13"	W160 x D42 x H16 cm   21 kg W164 x D89 x H9 cm   48 kg W75 x D27 x H8 cm   11 kg	3 box   1 pcs.	27.100,00
7J1	L150 x W150 x H74 cm L59.06 x W59.06 x 29.13"	W160 x D42 x H16 cm   21 kg W164 x D89 x H9 cm   48 kg W75 x D27 x H8 cm   11 kg	3 box   1 pcs.	27.100,00
8H	L200 x W100 x H74 cm L78.74" x W39.37" x 29.13"	W75 x D27 x H8 cm   11 kg W202 x D42 x H14,5 cm   16 kg W214 x D114 x H4,5 cm   32 kg	3 box   1 pcs.	21.400,00
8H1	L200 x W100 x H74 cm L78.74" x W39.37" x 29.13"	W75 x D27 x H8 cm   11 kg W202 x D42 x H14,5 cm   16 kg W214 x D114 x H4,5 cm   32 kg	3 box   1 pcs.	21.400,00

# 24% rabatt ska dras av på angivna priser

## TABLE INCL. CABLE MANAGEMENT CENTER OR PREPARED FOR TABLE SCREENS | 4 LEGS

12 mm tabletop in MDF with linoleum or 10 mm tabletop in MDF with veneer. Incl. 40 mm cable management cover or prepared for table screens. Tabletop is placed inside the table frame. 4 legs incl. adjustable gliders. Requires assembly. Table screens and STEP modules not included.

Order produced

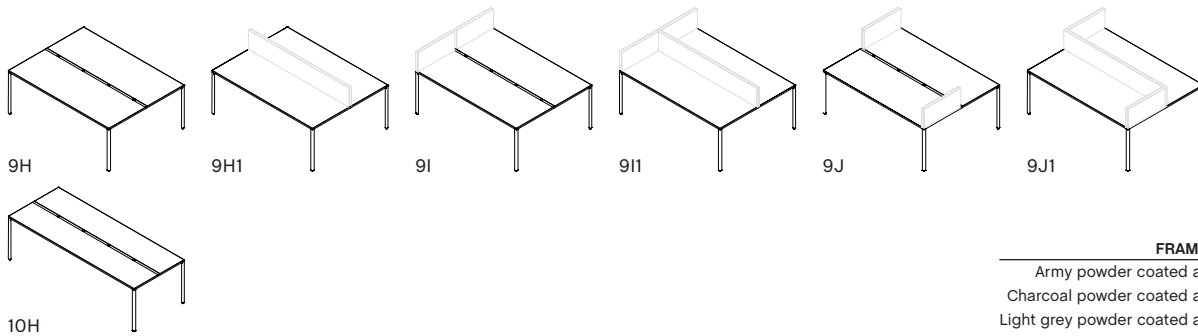

FRAME & LEGS		TABLETOP			
Army powder coated aluminium		Cloud grey linoleum	Dark grey linoleum	Green linoleum	Grey linoleum
Charcoal powder coated aluminium					
Light grey powder coated aluminium					

VARIANT	DIMENSION	BOX DIMENSION   WEIGHT	PACKAGING	PRICE
9H	L200 x W150 x H74 cm L78.74" x W150 x H74 cm	W252 x D42 x H16 cm   22 kg W214 x D89 x H9 cm   38 kg W75 x D27 x H8 cm   6 kg	3 box   1 pcs.	24.400,00
9H1	L200 x W150 x H74 cm L78.74" x W150 x H74 cm	W252 x D42 x H16 cm   22 kg W214 x D89 x H9 cm   38 kg W75 x D27 x H8 cm   6 kg	3 box   1 pcs.	24.400,00
9I	L200 x W150 x H74 cm L78.74" x W150 x H74 cm	W252 x D42 x H16 cm   22 kg W214 x D89 x H9 cm   38 kg W75 x D27 x H8 cm   6 kg	3 box   1 pcs.	30.650,00
9I1	L200 x W150 x H74 cm L78.74" x W150 x H74 cm	W252 x D42 x H16 cm   22 kg W214 x D89 x H9 cm   38 kg W75 x D27 x H8 cm   6 kg	3 box   1 pcs.	30.650,00
9J	L200 x W150 x H74 cm L78.74" x W150 x H74 cm	W252 x D42 x H16 cm   22 kg W214 x D89 x H9 cm   38 kg W75 x D27 x H8 cm   6 kg	3 box   1 pcs.	30.650,00
9J1	L200 x W150 x H74 cm L78.74" x W150 x H74 cm	W252 x D42 x H16 cm   22 kg W214 x D89 x H9 cm   38 kg W75 x D27 x H8 cm   6 kg	3 box   1 pcs.	30.650,00
10H	L250 x W100 x H74 cm L98.43" x W39.37" x 29.13"	W252 x D42 x H16 cm   20 kg W264 x D114 x H4,5 cm   38 kg W75 x D27 x H8 cm   6 kg	3 box   1 pcs.	27.800,00

## TABLE INCL. PLUG & PLAY CABLE MANAGEMENT CENTER OR PREPARED FOR TABLE SCREENS | 4 LEGS

12 mm tabletop in MDF with linoleum or 10 mm tabletop in MDF with veneer. Incl. 80 mm plug & play cable management cover or prepared for table screens. Tabletop is placed inside the table frame. 4 legs incl. adjustable gliders. Requires assembly. Table screens and STEP modules not included.

Order produced

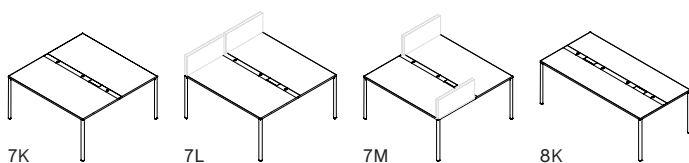

FRAME & LEGS		TABLETOP			
Army powder coated aluminium		Cloud grey linoleum	Dark grey linoleum	Green linoleum	Grey linoleum
Charcoal powder coated aluminium					
Light grey powder coated aluminium					

VARIANT	DIMENSION	BOX DIMENSION   WEIGHT	PACKAGING	PRICE
7K	L150 x W150 x H74 cm L59.06 x W59.06 x 29.13"	W252 x D42 x H16 cm   22 kg W214 x D89 x H9 cm   38 kg W75 x D27 x H8 cm   6 kg	3 box   1 pcs.	26.300,00
7L	L150 x W150 x H74 cm L59.06 x W59.06 x 29.13"	W252 x D42 x H16 cm   22 kg W214 x D89 x H9 cm   38 kg W75 x D27 x H8 cm   6 kg	3 box   1 pcs.	28.650,00
7M	L150 x W150 x H74 cm L59.06 x W59.06 x 29.13"	W252 x D42 x H16 cm   22 kg W214 x D89 x H9 cm   38 kg W75 x D27 x H8 cm   6 kg	3 box   1 pcs.	28.650,00
8K	L250 x W100 x H74 cm L98.43" x W39.37" x 29.13"	W252 x D42 x H16 cm   20 kg W264 x D114 x H4,5 cm   38 kg W75 x D27 x H8 cm   6 kg	3 box   1 pcs.	26.900,00

# 24% rabatt ska dras av på angivna priser

## TABLE INCL. PLUG & PLAY CABLE MANAGEMENT CENTER OR PREPARED FOR TABLE SCREENS | 4 LEGS

12 mm tabletop in MDF with linoleum or 10 mm tabletop in MDF with veneer. Incl. 80 mm plug & play cable management cover or prepared for table screens. Tabletop is placed inside the table frame. 4 legs incl. adjustable gliders. Requires assembly. Table screens and STEP modules not included.

Order produced

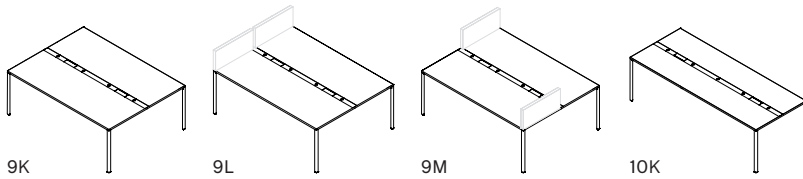

FRAME & LEGS	TABLETOP			
	Army powder coated aluminium	Cloud grey linoleum	Dark grey linoleum	Green linoleum
Charcoal powder coated aluminium	•	•	•	•
Light grey powder coated aluminium	•	•	•	•

VARIANT	DIMENSION	BOX DIMENSION   WEIGHT	PACKAGING	PRICE
9K	L200 x W150 x H74 cm L78.74" x W150 x H74 cm	W202 x D42 x H14,5 cm   16 kg W75 x D27 x H8 cm   6 kg W214 x D114 x H4,5 cm   32 kg	3 box   1 pcs.	29.900,00
9L	L200 x W150 x H74 cm L78.74" x W150 x H74 cm	W202 x D42 x H14,5 cm   16 kg W75 x D27 x H8 cm   6 kg W214 x D114 x H4,5 cm   32 kg	3 box   1 pcs.	32.250,00
9M	L200 x W150 x H74 cm L78.74" x W150 x H74 cm	W160 x D42 x H16 cm   21 kg W164 x D89 x H9 cm   48 kg W75 x D27 x H8 cm   11 kg	3 box   1 pcs.	32.250,00
10K	L150 x W150 x H74 cm L59.06 x W59.06 x 29.13"	W202 x D42 x H14,5 cm   16 kg W75 x D27 x H8 cm   6 kg W214 x D114 x H4,5 cm   32 kg	3 box   1 pcs.	34.100,00

## TABLE INCL. DOUBLE PLUG & PLAY CABLE MANAGEMENT CENTER IN COMBINATION WITH TABLE SCREENS | 4 LEGS

12 mm tabletop in MDF with linoleum or 10 mm tabletop in MDF with veneer. Incl. 80 mm plug & play cable management cover and prepared for table screens. Tabletop is placed inside the table frame. 4 legs incl. adjustable gliders. Requires assembly. Table screens and STEP modules not included.

Order produced

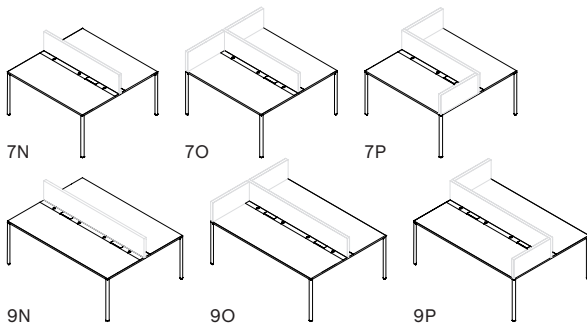

FRAME & LEGS	TABLETOP			
	Army powder coated aluminium	Cloud grey linoleum	Dark grey linoleum	Green linoleum
Charcoal powder coated aluminium	•	•	•	•
Light grey powder coated aluminium	•	•	•	•

VARIANT	DIMENSION	BOX DIMENSION   WEIGHT	PACKAGING	PRICE
7N	L150 x W150 x H74 cm L59.06 x W59.06 x 29.13"	W160 x D42 x H16 cm   21 kg W164 x D89 x H9 cm   48 kg W75 x D27 x H8 cm   11 kg	3 box   1 pcs.	27.850,00
7O	L150 x W150 x H74 cm L59.06 x W59.06 x 29.13"	W160 x D42 x H16 cm   21 kg W164 x D89 x H9 cm   48 kg W75 x D27 x H8 cm   11 kg	3 box   1 pcs.	30.250,00
7P	L150 x W150 x H74 cm L59.06 x W59.06 x 29.13"	W160 x D42 x H16 cm   21 kg W164 x D89 x H9 cm   48 kg W75 x D27 x H8 cm   11 kg	3 box   1 pcs.	30.250,00
9N	L150 x W150 x H74 cm L59.06 x W59.06 x 29.13"	W202 x D42 x H14,5 cm   16 kg W75 x D27 x H8 cm   6 kg W214 x D114 x H4,5 cm   32 kg	3 box   1 pcs.	30.800,00
9O	L200 x W150 x H74 cm L78.74" x W150 x H74 cm	W252 x D42 x H16 cm   22 kg W214 x D89 x H9 cm   38 kg W75 x D27 x H8 cm   6 kg	3 box   1 pcs.	33.150,00
9P	L200 x W150 x H74 cm L78.74" x W150 x H74 cm	W252 x D42 x H16 cm   22 kg W214 x D89 x H9 cm   38 kg W75 x D27 x H8 cm   6 kg	3 box   1 pcs.	33.150,00

# 24% rabatt ska dras av på angivna priser

## TABLE SCREEN EDGE | 58 | 73

Wood structure with MDF panels, 3 mm foam layer upholstered with textile. Incl. integrated brackets for mounting on the frame. Table screen edge can be mounted on tables in width 150 cm. Table screen edge 58 to be used in combination with top tray dividers.

Order produced



VARIANT	DIMENSION	BOX DIMENSION   WEIGHT	PACKAGING	FABRIC	PRICE
W58	W58 x D5 x H75 W22.83" x D1.97" x H29.53"	1 pcs. W58 x D5 x H33   3.6 kg	1 box   1 pcs.	Remix	4.550,00
				Surface By HAY	4.550,00
				Steelcut	5.000,00
				Steelcut Trio	5.000,00
				Canvas	5.150,00

VARIANT	DIMENSION	BOX DIMENSION   WEIGHT	PACKAGING	FABRIC	PRICE
W73	W73 x D4 x H33 W28.74" x D1.57" x H12.99"	1 pcs. W73 x D4 x H33   4.3 kg	1 box   1 pcs.	Remix	4.550,00
				Surface By HAY	4.550,00
				Steelcut	5.000,00
				Steelcut Trio	5.000,00
				Canvas	5.150,00

## TABLE SCREEN MIDDLE | 100 | 150 | 200

Wood structure with MDF panels, 3 mm foam layer upholstered with textile. Incl. integrated brackets for mounting into the frame. Table screen middle is mounted on the support bar.

Order produced



VARIANT	DIMENSION	BOX DIMENSION   WEIGHT	PACKAGING	FABRIC	PRICE
W100	W100 x D4 x H33 W39.37" x D1.57" x H12.99"	1 pcs. W100 x D4 x H33   5.5 kg	1 box   1 pcs.	Remix	4.550,00
				Surface By HAY	4.550,00
				Steelcut	5.000,00
				Steelcut Trio	5.000,00
				Canvas	5.150,00

VARIANT	DIMENSION	BOX DIMENSION   WEIGHT	PACKAGING	FABRIC	PRICE
W150	W150 x D4 x H33 W59.06" x D1.57" x H12.99"	1 pcs. W150 x D4 x H33   7.2 kg	1 box   1 pcs.	Remix	6.100,00
				Surface By HAY	6.100,00
				Steelcut	6.750,00
				Steelcut Trio	6.750,00
				Canvas	6.900,00

VARIANT	DIMENSION	BOX DIMENSION   WEIGHT	PACKAGING	FABRIC	PRICE
W200	W200 x D4 x H33 W78.74" x D1.57" x H12.99"	1 pcs. W200 x D4 x H33   10.8 kg	1 box   1 pcs.	Remix	8.450,00
				Surface By HAY	8.450,00
				Steelcut	9.100,00
				Steelcut Trio	9.100,00
				Canvas	9.250,00

# 24% rabatt ska dras av på angivna priser

## TABLE LEGS

Powder coated extruded aluminium. Incl. adjustable gliders.

Stock item

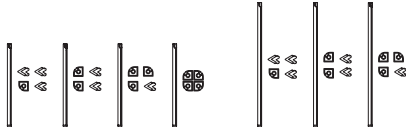

MATERIAL	COLOUR
Powder coated extruded aluminium	Army Charcoal Light grey

VARIANT	BOX DIMENSION   WEIGHT	PACKAGING	PRICE
H74   SET OF 1	1 pcs. W79 x D27 x H8   7.5 kg	1 box   1 pcs.	2.500,00
H74   SET OF 2	1 pcs. W79 x D27 x H8   8.5 kg	1 box   1 pcs.	3.450,00
H74   SET OF 3	1 pcs. W79 x D27 x H8   10 kg	1 box   1 pcs.	4.400,00
H74   SET OF 4	1 pcs. W79 x D27 x H8   11 kg	1 box   1 pcs.	5.300,00
H110   SET OF 1	1 pcs. W115 x D27 x H8   11 kg	1 box   1 pcs.	2.660,00
H110   SET OF 2	1 pcs. W115 x D27 x H8   13 kg	1 box   1 pcs.	3.750,00
H110   SET OF 3	1 pcs. W115 x D27 x H8   15 kg	1 box   1 pcs.	4.850,00

## DOUBLE TABLE LEGS

Powder coated extruded aluminium. Incl. adjustable gliders.

Stock item

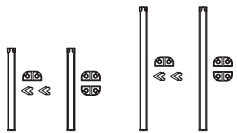

MATERIAL	COLOUR
Powder coated extruded aluminium	Army Charcoal Light grey

VARIANT	BOX DIMENSION   WEIGHT	PACKAGING	PRICE
H74   SET OF 1	1 pcs. W79 x D27 x H8   8.5 kg	1 box   1 pcs.	3.450,00
H74   SET OF 2	1 pcs. W79 x D27 x H8   11 kg	1 box   1 pcs.	5.300,00
H110   SET OF 1	1 pcs. W115 x D27 x H8   13 kg	1 box   1 pcs.	3.750,00
H110   SET OF 2	1 pcs. W115 x D27 x H8   X kg	1 box   1 pcs.	5.950,00



# 24% rabatt ska dras av på angivna priser

## TABLE CONNECTORS

Powder coated steel

Stock item

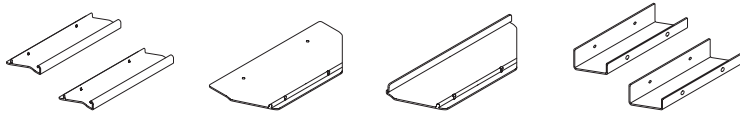

MATERIAL	COLOUR		
	Army	Charcoal	Light grey
Powder coated steel	•	•	•

VARIANT	BOX DIMENSION   WEIGHT	PACKAGING	PRICE
FRONT   SET OF 2	1 pcs. W26.5 x D15 x H7.5   0.5 kg	1 box   1 pcs.	300,00
END SHELF	1 pcs. W28 x D10 x H1.5   0.25 kg	1 box   1 pcs.	300,00
END TRAY	1 pcs. W28 x D13.5 x H1.5   0.25 kg	1 box   1 pcs.	300,00
WALL   SET OF 2	1 pcs. W26 x D15.5 x H7.5   0.7 kg	1 box   1 pcs.	790,00

## CABLE CLIP | SET OF 2

Black PP plastic. To be mounted in the frame channel underneath the table or in a support bar to hold cables. Max. 3 standard cables.

Stock item

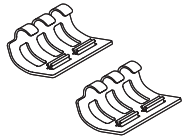

MATERIAL	COLOUR
	Black

VARIANT	DIMENSION	BOX DIMENSION   WEIGHT	PACKAGING	PRICE
SET OF 2	W6 x D4 x H3 W2.36" x D1.57" x H1.18"	1 pcs. W6.5 x D4.5 x H3.5   0.05 kg	1 box   1 pcs.	49,00

## CABLE GUIDE FOR TABLE LEG | H74

ABS plastic. Recommended for maximum 3 standard cables.

Stock item

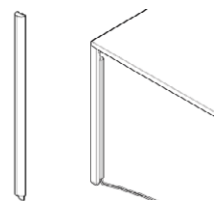

MATERIAL	COLOUR		
	Army	Charcoal	Light grey
ABS Plastic	•	•	•

VARIANT	DIMENSION	BOX DIMENSION   WEIGHT	PACKAGING	PRICE
H74	W3,30 x D2,2 x H64 cm W1,3" x D0,87" x H25,2"	1 pcs.   W3,30 x D2,2 x H64 cm   0,05 kg	1 box   1 pcs.	49,00

# 24% rabatt ska dras av på angivna priser

## HIGH TABLE HT-5 | H90 CM

12 mm tabletop in MDF with linoleum or 10 mm tabletop in MDF with veneer.  
Tabletop is placed inside the table frame. 4 legs in two heights incl. adjustable gliders. STEP modules not included. Requires assembly.

Order produced

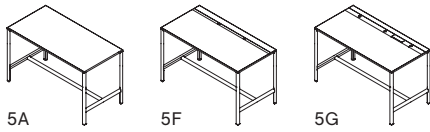

FRAME & LEGS	TABLETOP			
	Army powder coated aluminium	Cloud grey linoleum	Dark grey linoleum	Green linoleum
Charcoal powder coated aluminium	•	•	•	•
Light grey powder coated aluminium	•	•	•	•

VARIANT	DIMENSION	BOX DIMENSION   WEIGHT	PACKAGING	PRICE
HT90-5A	L150 x W75 x H90 cm L59.06" x W29.53" x 35.43"	W163 x D88,5 x H2,5 cm   14,6 kg W160 X D85 X H8 cm   12 kg W115 x D27 x H8 cm   16 kg W163 x D42 x H16 cm   9 kg	4 box   1 pcs.	22.500,00
HT90-5F CABLEM. EDGE	L150 x W75 x H90 cm L59.06" x W29.53" x 35.43"	W163 x D88,5 x H2,5 cm   14,6 kg W160 X D85 X H8 cm   12 kg W115 x D27 x H8 cm   16 kg W163 x D42 x H16 cm   17 kg	4 box   1 pcs.	27.200,00
HT90-5G PLUG & PLAY CABLEM. EDGE	L150 x W75 x H90 cm L59.06" x W29.53" x 35.43"	W163 x D88,5 x H2,5 cm   14,6 kg W160 X D85 X H8 cm   12 kg W115 x D27 x H8 cm   16 kg W163 x D42 x H16 cm   12 kg	4 box   1 pcs.	28.750,00

## HIGH TABLE HT-12 | H90 CM

12 mm tabletop in MDF with linoleum or 10 mm tabletop in MDF with veneer.  
Tabletop is placed inside the table frame. 4 legs in two heights incl. adjustable gliders. STEP modules not included. Requires assembly.

Order produced

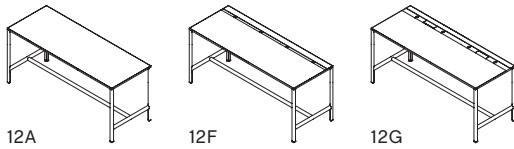

FRAME & LEGS	TABLETOP			
	Army powder coated aluminium	Cloud grey linoleum	Dark grey linoleum	Green linoleum
Charcoal powder coated aluminium	•	•	•	•
Light grey powder coated aluminium	•	•	•	•

VARIANT	DIMENSION	BOX DIMENSION   WEIGHT	PACKAGING	PRICE
HT90-12A	L200 x W75 x H90 cm L78.74" x W29.53" x 35.43"	W213,5 x D88,5 x H2,5 cm   19,1 kg W210 x D85 x H8 cm   15 kg W115 x D27 x H8 cm   16 kg W210 x D42 x H16 cm   15 kg	4 box   1 pcs.	24.850,00
HT90-12F CABLEM. EDGE	L200 x W75 x H90 cm L78.74" x W29.53" x 35.43"	W213,5 x D88,5 x H2,5 cm   19,1 kg W210 x D85 x H8 cm   15 kg W115 x D27 x H8 cm   16 kg W210 x D42 x H16 cm   17 kg	4 box   1 pcs.	30.600,00
HT90-12G PLUG & PLAY CABLEM. EDGE	L200 x W75 x H90 cm L78.74" x W29.53" x 35.43"	W213,5 x D88,5 x H2,5 cm   19,1 kg W210 x D85 x H8 cm   15 kg W115 x D27 x H8 cm   16 kg W210 x D42 x H16 cm   17,5 kg	4 box   1 pcs.	32.200,00

# 24% rabatt ska dras av på angivna priser

## HIGH TABLE HT-6 | H90 CM

12 mm tabletop in MDF with linoleum or 10 mm tabletop in MDF with veneer. Tabletop is placed inside the table frame. 4 legs in two heights incl. adjustable gliders. STEP modules not included. Requires assembly.

Order produced

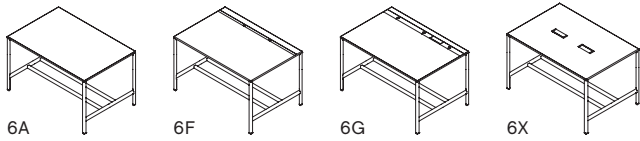

FRAME & LEGS		TABLETOP			
Army powder coated aluminium		Cloud grey linoleum	Dark grey linoleum	Green linoleum	Grey linoleum
Charcoal powder coated aluminium					Water-based lacquered oak veneer
Light grey powder coated aluminium					

VARIANT	DIMENSION	BOX DIMENSION   WEIGHT	PACKAGING	PRICE
HT90-6A	L150 x W100 x H90 cm L59.06" x W39.37" x 35.43"	W163 x D113,5 x H2,5 cm   19,3 kg W160 x D110 x H8 cm   13 kg W115 x D27 x H8 cm   16 kg W163 x D42 x H16 cm   14 kg	4 box   1 pcs.	22.350,00
HT90-6F CABLEM. EDGE	L150 x W100 x H90 cm L59.06" x W39.37" x 35.43"	W163 x D113,5 x H2,5 cm   19,3 kg W160 x D110 x H8 cm   13 kg W115 x D27 x H8 cm   16 kg W163 x D42 x H16 cm   16 kg	4 box   1 pcs.	27.050,00
HT90-6G PLUG & PLAY CABLEM. EDGE	L150 x W100 x H90 cm L59.06" x W39.37" x 35.43"	W163 x D113,5 x H2,5 cm   19,3 kg W160 x D110 x H8 cm   13 kg W115 x D27 x H8 cm   16 kg W163 x D42 x H16 cm   14,5 kg	4 box   1 pcs.	28.600,00
HT90-6X SINGLE PLUG & PLAY X 2 CENTER	L150 x W100 x H90 cm L59.06" x W39.37" x 35.43"	W163 x D113,5 x H2,5 cm   19,3 kg W160 x D110 x H8 cm   13 kg W115 x D27 x H8 cm   16 kg W163 x D42 x H16 cm   14 kg	4 box   1 pcs.	28.600,00

## HIGH TABLE HT-3 | H90 CM

12 mm tabletop in MDF with linoleum or 10 mm tabletop in MDF with veneer. Tabletop is placed inside the table frame. 4 legs in two heights incl. adjustable gliders. STEP modules, top tray and single profiles not included. Requires assembly.

Order produced

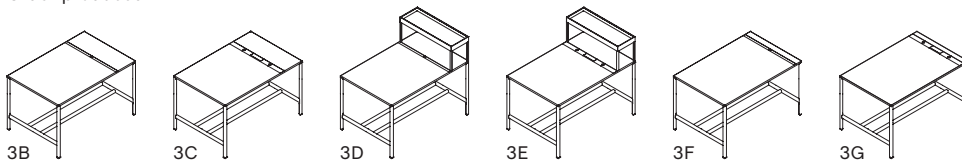

FRAME & LEGS		TABLETOP			
Army powder coated aluminium		Cloud grey linoleum	Dark grey linoleum	Green linoleum	Grey linoleum
Charcoal powder coated aluminium					Water-based lacquered oak veneer
Light grey powder coated aluminium					

VARIANT	DIMENSION	BOX DIMENSION   WEIGHT	PACKAGING	PRICE
HT90-3B CABLEM. EDGE 34 CM	L100 x W150 x H90 cm L39.37" x W59.06" x 35.43"	W163 x D113,5 x H2,5 cm   19,3 kg W160 x D110 x H8 cm   13 kg W115 x D27 x H8 cm   16 kg W163 x D42 x H16 cm   13 kg	4 box   1 pcs.	25.000,00
HT90-3C PLUG & PLAY CABLEM. EDGE 34 CM	L100 x W150 x H90 cm L39.37" x W59.06" x 35.43"	W163 x D113,5 x H2,5 cm   19,3 kg W160 x D110 x H8 cm   13 kg W115 x D27 x H8 cm   16 kg W163 x D42 x H16 cm   12 kg	4 box   1 pcs.	27.050,00
HT90-3D CABLEM. EDGE 34 CM + TRAY DIVIDER	L100 x W150 x H90 cm L39.37" x W59.06" x 35.43"	W163 x D113,5 x H2,5 cm   19,3 kg W160 x D110 x H8 cm   13 kg W115 x D27 x H8 cm   16 kg W163 x D42 x H16 cm   13 kg	4 box   1 pcs.	25.800,00
HT90-3E PLUG & PLAY CABLEM. EDGE 34 CM + TRAY DIVIDER	L100 x W150 x H90 cm L39.37" x W59.06" x 35.43"	W163 x D113,5 x H2,5 cm   19,3 kg W160 x D110 x H8 cm   13 kg W115 x D27 x H8 cm   16 kg W163 x D42 x H16 cm   12 kg	4 box   1 pcs.	27.800,00
HT90-3F CABLEM. EDGE	L100 x W150 x H90 cm L39.37" x W59.06" x 35.43"	W163 x D113,5 x H2,5 cm   19,3 kg W160 x D110 x H8 cm   13 kg W115 x D27 x H8 cm   16 kg W163 x D42 x H16 cm   13 kg	4 box   1 pcs.	25.000,00
HT90-3G PLUG & PLAY CABLEM. EDGE	L100 x W150 x H90 cm L39.37" x W59.06" x 35.43"	W163 x D113,5 x H2,5 cm   19,3 kg W160 x D110 x H8 cm   13 kg W115 x D27 x H8 cm   16 kg W163 x D42 x H16 cm   12 kg	4 box   1 pcs.	27.050,00

# 24% rabatt ska dras av på angivna priser

## HIGH TABLE HT-8 | H90 CM

12 mm tabletop in MDF with linoleum or 10 mm tabletop in MDF with veneer.  
Tabletop is placed inside the table frame. 4 legs in two heights incl. adjustable gliders. STEP modules not included. Requires assembly.

Order produced

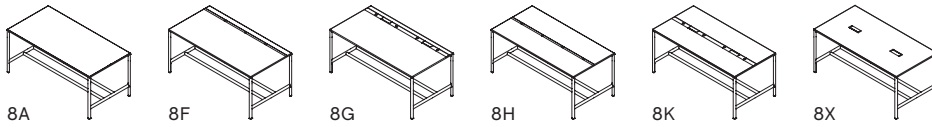

FRAME & LEGS	TABLETOP			
	Cloud grey linoleum	Dark grey linoleum	Green linoleum	Grey linoleum
Army powder coated aluminium	•	•	•	•
Charcoal powder coated aluminium	•	•	•	•
Light grey powder coated aluminium	•	•	•	•

VARIANT	DIMENSION	BOX DIMENSION   WEIGHT	PACKAGING	PRICE
HT90-8A	L200 x W100 x H90 cm L78.74" x W39.37" x 35.43"	W213,5 x D113,5 x H2,5 cm   25,6 kg W210 x D110 x H8 cm   16 kg W115 x D27 x H8 cm   16 kg W213 x D42 x H16 cm   18 kg	4 box   1 pcs.	25.150,00
HT90-8F CABLEM. EDGE	L200 x W100 x H90 cm L78.74" x W39.37" x 35.43"	W213,5 x D113,5 x H2,5 cm   25,6 kg W210 x D110 x H8 cm   16 kg W115 x D27 x H8 cm   16 kg W213 x D42 x H16 cm   19,5 kg	4 box   1 pcs.	27.000,00
HT90-8G PLUG & PLAY CABLEM. EDGE	L200 x W100 x H90 cm L78.74" x W39.37" x 35.43"	W213,5 x D113,5 x H2,5 cm   25,6 kg W210 x D110 x H8 cm   16 kg W115 x D27 x H8 cm   16 kg W213 x D42 x H16 cm   19,5 kg	4 box   1 pcs.	32.500,00
HT90-8H CABLEM. CENTER	L200 x W100 x H90 cm L78.74" x W39.37" x 35.43"	W213,5 x D113,5 x H2,5 cm   25,6 kg W210 x D110 x H8 cm   16 kg W115 x D27 x H8 cm   16 kg W213 x D42 x H16 cm   16 kg	4 box   1 pcs.	27.000,00
HT90-8K PLUG & PLAY CABLEM. CENTER	L200 x W100 x H90 cm L78.74" x W39.37" x 35.43"	W213,5 x D113,5 x H2,5 cm   25,6 kg W210 x D110 x H8 cm   16 kg W115 x D27 x H8 cm   16 kg W213 x D42 x H16 cm   22 kg	4 box   1 pcs.	32.500,00
HT90-8X SINGLE PLUG & PLAY X 2 CENTER	L200 x W100 x H90 cm L78.74" x W39.37" x 35.43"	W213,5 x D113,5 x H2,5 cm   25,6 kg W210 x D110 x H8 cm   16 kg W115 x D27 x H8 cm   16 kg W213 x D42 x H16 cm   19 kg	4 box   1 pcs.	32.500,00

## HIGH TABLE HT-5 | H105 CM

12 mm tabletop in MDF with linoleum or 10 mm tabletop in MDF with veneer.  
Tabletop is placed inside the table frame. 4 legs in two heights incl. adjustable gliders. STEP modules not included. Requires assembly.

Order produced

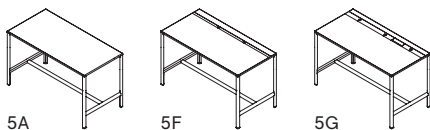

FRAME & LEGS	TABLETOP			
	Cloud grey linoleum	Dark grey linoleum	Green linoleum	Grey linoleum
Army powder coated aluminium	•	•	•	•
Charcoal powder coated aluminium	•	•	•	•
Light grey powder coated aluminium	•	•	•	•

VARIANT	DIMENSION	BOX DIMENSION   WEIGHT	PACKAGING	PRICE
HT105-5A	L150 x W75 x H105 cm L59.06" x W29.53" x 41.34"	W163 x D88,5 x H2,5 cm   14,6 kg W160 x D85 x H8 cm   12 kg W115 x D27 x H8 cm   17 kg W213 x D42 x H16 cm   9 kg	4 box   1 pcs.	22.650,00
HT105-5F CABLEM. EDGE	L150 x W75 x H105 cm L59.06" x W29.53" x 41.34"	W163 x D88,5 x H2,5 cm   14,6 kg W160 x D85 x H8 cm   12 kg W115 x D27 x H8 cm   17 kg W213 x D42 x H16 cm   17 kg	4 box   1 pcs.	27.350,00
HT105-5G PLUG & PLAY CABLEM. EDGE	L150 x W75 x H105 cm L59.06" x W29.53" x 41.34"	W163 x D88,5 x H2,5 cm   14,6 kg W160 x D85 x H8 cm   12 kg W115 x D27 x H8 cm   17 kg W213 x D42 x H16 cm   12 kg	4 box   1 pcs.	28.900,00

# 24% rabatt ska dras av på angivna priser

## HIGH TABLE HT-12 | H105 CM

12 mm tabletop in MDF with linoleum or 10 mm tabletop in MDF with veneer. Tabletop is placed inside the table frame. 4 legs in two heights incl. adjustable gliders. STEP modules not included. Requires assembly.

Order produced

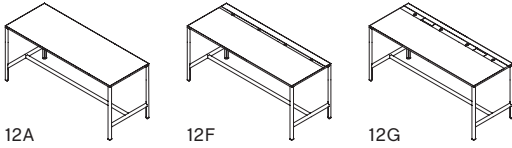

VARIANT	DIMENSION	BOX DIMENSION   WEIGHT	PACKAGING	PRICE
HT105-12A	L200 x W75 x H105 cm L78.74" x W29.53" x 41.34"	W213,5 x D88,5 x H2,5 cm   19,1 kg W210 x D85 x H8 cm   15 kg W115 x D27 x H8 cm   16 kg W210 x D42 x H16 cm   16 kg	4 box   1 pcs.	25.000,00
HT105-12F CABLEM. EDGE	L200 x W75 x H105 cm L78.74" x W29.53" x 41.34"	W213,5 x D88,5 x H2,5 cm   19,1 kg W210 x D85 x H8 cm   15 kg W115 x D27 x H8 cm   16 kg W210 x D42 x H16 cm   17 kg	4 box   1 pcs.	30.750,00
HT105-12G PLUG & PLAY CABLEM. EDGE	L200 x W75 x H105 cm L78.74" x W29.53" x 41.34"	W213,5 x D88,5 x H2,5 cm   19,1 kg W210 x D85 x H8 cm   15 kg W115 x D27 x H8 cm   16,17,5 kg	4 box   1 pcs.	32.350,00

FRAME & LEGS	TABLETOP
Army powder coated aluminium	Cloud grey linoleum
Charcoal powder coated aluminium	Dark grey linoleum
Light grey powder coated aluminium	Green linoleum
	Grey linoleum
	Water-based lacquered oak veneer

## HIGH TABLE HT-6 | H105 CM

12 mm tabletop in MDF with linoleum or 10 mm tabletop in MDF with veneer. Tabletop is placed inside the table frame. 4 legs in two heights incl. adjustable gliders. STEP modules not included. Requires assembly.

Order produced

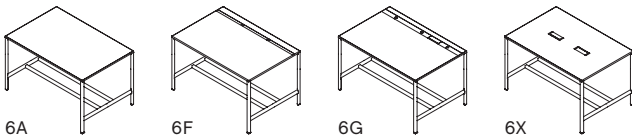

VARIANT	DIMENSION	BOX DIMENSION   WEIGHT	PACKAGING	PRICE
HT105-6A	L150 x W100 x H105 cm L59.06" x W39.37" x 41.34"	W163 x D113,5 x H2,5 cm   19,3 kg W160 x D110 x H8 cm   13 kg W115 x D27 x H8 cm   16 kg W163 x D42 x H16 cm   19,3 kg	4 box   1 pcs.	22.500,00
HT105-6F CABLEM. EDGE	L150 x W100 x H105 cm L59.06" x W39.37" x 41.34"	W163 x D113,5 x H2,5 cm   19,3 kg W160 x D110 x H8 cm   13 kg W115 x D27 x H8 cm   16 kg W163 x D42 x H16 cm   16 kg	4 box   1 pcs.	27.200,00
HT105-6G PLUG & PLAY CABLEM. EDGE	L150 x W100 x H105 cm L59.06" x W39.37" x 41.34"	W163 x D113,5 x H2,5 cm   19,3 kg W160 x D110 x H8 cm   13 kg W115 x D27 x H8 cm   16 kg W163 x D42 x H16 cm   14,5 kg	4 box   1 pcs.	28.750,00
HT105-6X SINGLE PLUG & PLAY X 2 CENTER	L150 x W100 x H105 cm L59.06" x W39.37" x 41.34"	W163 x D113,5 x H2,5 cm   19,3 kg W160 x D110 x H8 cm   13 kg W115 x D27 x H8 cm   16 kg W163 x D42 x H16 cm   14 kg	4 box   1 pcs.	28.750,00

FRAME & LEGS	TABLETOP
Army powder coated aluminium	Cloud grey linoleum
Charcoal powder coated aluminium	Dark grey linoleum
Light grey powder coated aluminium	Green linoleum
	Grey linoleum
	Water-based lacquered oak veneer

# 24% rabatt ska dras av på angivna priser

## HIGH TABLE HT-3 | H105 CM

12 mm tabletop in MDF with linoleum or 10 mm tabletop in MDF with veneer.  
Tabletop is placed inside the table frame. 4 legs in two heights incl. adjustable gliders. STEP modules, top tray and single profiles not included. Requires assembly.

Order produced

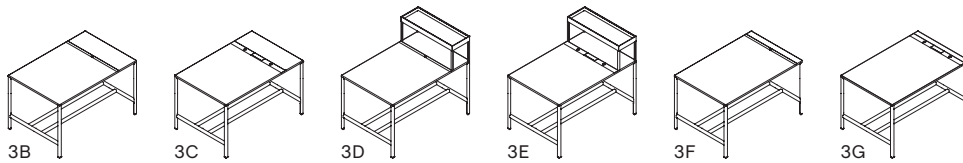

FRAME & LEGS	TABLETOP			
	Army powder coated aluminium	Cloud grey linoleum	Dark grey linoleum	Green linoleum
Charcoal powder coated aluminium	•	•	•	•
Light grey powder coated aluminium	•	•	•	•

Water-based lacquered oak veneer

VARIANT	DIMENSION	BOX DIMENSION   WEIGHT	PACKAGING	PRICE
HT105-3B CABLEM. EDGE 34 CM	L100 x W150 x H105 cm L39.37" x W59.06" x 41.34"	W163 x D113,5 x H2,5 cm   19,3 kg W160 x D110 x H8 cm   13 kg W115 x D27 x H8 cm   16 kg W163 x D42 x H16 cm   13 kg	4 box   1 pcs.	25.150,00
HT105-3C PLUG & PLAY CABLEM. EDGE 34 CM	L100 x W150 x H105 cm L39.37" x W59.06" x 41.34"	W163 x D113,5 x H2,5 cm   19,3 kg W160 x D110 x H8 cm   13 kg W115 x D27 x H8 cm   16 kg W163 x D42 x H16 cm   12 kg	4 box   1 pcs.	27.200,00
HT105-3D CABLEM. EDGE 34 CM + TRAY DIVIDER	L100 x W150 x H105 cm L39.37" x W59.06" x 41.34"	W163 x D113,5 x H2,5 cm   19,3 kg W160 x D110 x H8 cm   13 kg W115 x D27 x H8 cm   16 kg W163 x D42 x H16 cm   13 kg	4 box   1 pcs.	25.950,00
HT105-3E PLUG & PLAY CABLEM. EDGE 34 CM + TRAY DIVIDER	L100 x W150 x H105 cm L39.37" x W59.06" x 41.34"	W163 x D113,5 x H2,5 cm   19,3 kg W160 x D110 x H8 cm   13 kg W115 x D27 x H8 cm   16 kg W163 x D42 x H16 cm   12 kg	4 box   1 pcs.	27.950,00
HT105-3F CABLEM. EDGE	L100 x W150 x H105 cm L39.37" x W59.06" x 41.34"	W163 x D113,5 x H2,5 cm   19,3 kg W160 x D110 x H8 cm   13 kg W115 x D27 x H8 cm   16 kg W163 x D42 x H16 cm   13 kg	4 box   1 pcs.	25.150,00
HT105-3G PLUG & PLAY CABLEM. EDGE	L100 x W150 x H105 cm L39.37" x W59.06" x 41.34"	W163 x D113,5 x H2,5 cm   19,3 kg W160 x D110 x H8 cm   13 kg W115 x D27 x H8 cm   16 kg W163 x D42 x H16 cm   12 kg	4 box   1 pcs.	27.200,00

# 24% rabatt ska dras av på angivna priser

## HIGH TABLE HT-8 | H105 CM

12 mm tabletop in MDF with linoleum or 10 mm tabletop in MDF with veneer. Tabletop is placed inside the table frame. 4 legs in two heights incl. adjustable gliders. STEP modules not included. Requires assembly.

Order produced

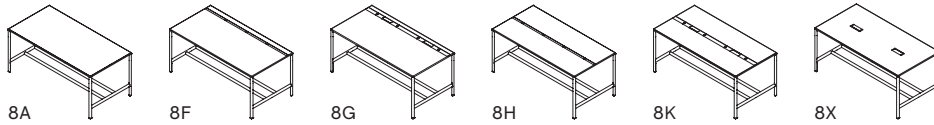

FRAME & LEGS	TABLETOP			
	Cloud grey linoleum	Dark grey linoleum	Green linoleum	Grey linoleum
Army powder coated aluminium	•	•	•	•
Charcoal powder coated aluminium	•	•	•	•
Light grey powder coated aluminium	•	•	•	•

Water-based lacquered oak veneer

VARIANT	DIMENSION	BOX DIMENSION   WEIGHT	PACKAGING	PRICE
HT105-8A	L200 x W100 x H105 cm L78.74" x W39.37" x 41.34"	W213,5 x D113,5 x H2,5 cm   25,6 kg W210 x D110 x H8 cm   16 kg W115 x D27 x H8 cm   16 kg W213 x D42 x H16 cm   18 kg	4 box   1 pcs.	25.300,00
HT105-8F CABLEM. EDGE	L200 x W100 x H105 cm L78.74" x W39.37" x 41.34"	W213,5 x D113,5 x H2,5 cm   25,6 kg W210 x D110 x H8 cm   16 kg W115 x D27 x H8 cm   16 kg W213 x D42 x H16 cm   19,5 kg	4 box   1 pcs.	27.150,00
HT105-8G PLUG & PLAY CABLEM. EDGE	L200 x W100 x H105 cm L78.74" x W39.37" x 41.34"	W213,5 x D113,5 x H2,5 cm   25,6 kg W210 x D110 x H8 cm   16 kg W115 x D27 x H8 cm   16 kg W213 x D42 x H16 cm   19,5 kg	4 box   1 pcs.	32.650,00
HT105-8H CABLEM. CENTER	L200 x W100 x H105 cm L78.74" x W39.37" x 41.34"	W213,5 x D113,5 x H2,5 cm   25,6 kg W210 x D110 x H8 cm   16 kg W115 x D27 x H8 cm   16 kg W213 x D42 x H16 cm   16 kg	4 box   1 pcs.	27.150,00
HT105-8K PLUG & PLAY CABLEM. CENTER	L200 x W100 x H105 cm L78.74" x W39.37" x 41.34"	W213,5 x D113,5 x H2,5 cm   25,6 kg W210 x D110 x H8 cm   16 kg W115 x D27 x H8 cm   16 kg W213 x D42 x H16 cm   22 kg	4 box   1 pcs.	32.650,00
HT105-8X SINGLE PLUG & PLAY X 2 CENTER	L200 x W100 x H105 cm L78.74" x W39.37" x 41.34"	W213,5 x D113,5 x H2,5 cm   25,6 kg W210 x D110 x H8 cm   16 kg W115 x D27 x H8 cm   16 kg W213 x D42 x H16 cm   19 kg	4 box   1 pcs.	32.650,00

# 24% rabatt ska dras av på angivna priser

## CABLE TRAY | 35

Powder coated steel.

Stock item

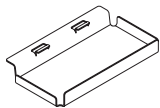

MATERIAL	COLOUR
Powder coated steel	Charcoal

VARIANT	DIMENSION	BOX DIMENSION   WEIGHT	PACKAGING	PRICE
W35	W35 x D21 x H4,2 W13.78" x D8.27" x H1.65"	1 pcs. W38 x D23 x H6   1 kg	1 box   1 pcs.	500,00

## CABLE TRAY FOR STEP MODULE | 35

Powder coated steel. Prepared for STEP Module.

Stock item

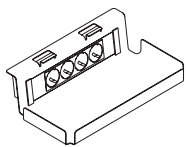

MATERIAL	COLOUR
Powder coated steel	Army Charcoal Light grey

VARIANT	DIMENSION	BOX DIMENSION   WEIGHT	PACKAGING	PRICE
W35	W35 x D21 x H7 W13.78" x D8.27" x H2.76"	1 pcs. W38 x D23 x H9   1.2 kg	1 box   1 pcs.	630,00



# 24% rabatt ska dras av på angivna priser

## STEP MODULES FOR CABLE MANAGEMENT

STEP BASE in plastic and STEP ALU in aluminium. NO STEP module power strip profile with 3 or 4 outlets. Customer outlets CAT6 or HDMI are sold separately. The custom module fits two customer outlets. The STEP Module fits into NO support bar or cable tray prepared for STEP module.

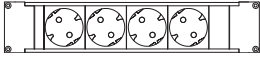
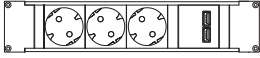
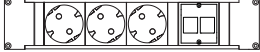

Stock item

	COLOUR
	Charcoal
	MATERIAL
	Powder coated steel

CEE/GE++   PLUG TYPE F	VARIANT	DIMENSION	BOX DIMENSION   WEIGHT	PACKAGING	PRICE
	4 OUTLETS	W30 x D5,5 x H4,5 W11.81" x D2.17" x H1.77"	1 pcs. W32 x D7.5 x H6.5   0.35 kg1 box   1 pcs.		790,00
	3 OUTLETS + 1 DOUBLE USB	W30 x D5,5 x H4,5 W11.81" x D2.17" x H1.77"	1 pcs. W32 x D7.5 x H6.5   0.35 kg1 box   1 pcs.		1.250,00
	3 OUTLETS + 1 CUSTOMER MODULE W/2 OUTLET	W30 x D5,5 x H4,5 W11.81" x D2.17" x H1.77"	1 pcs. W32 x D7.5 x H6.5   0.35 kg1 box   1 pcs.		870,00

### PLUG TYPE F (CEE GE++)

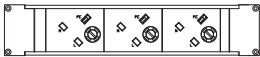
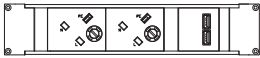
AD, AF, AL, AM, AN (CW, SX, BQ), AS, AT, AW, AZ, BA, BG, BT, BY, CV, DE, DK, DZ, EE, EG, ES, ET, FI, FO, GE, GL, GN, GR, HR, HU, ID, IS, IR, IT, JO, KG, KP, KR, KZ, LA, LR, LT, LU, LV, LY, MC, MD, ME, MF, MK, MM, MO, MZ, NC, NE, NL, NO, PT, RO, RS, RU, SE, SI, SM, SR, ST, TD, TH, TJ, TL, TM, TR, UA, UY, VN

UK++   PLUG TYPE G	VARIANT	DIMENSION	BOX DIMENSION   WEIGHT	PACKAGING	PRICE
	3 OUTLES	W30 x D5,5 x H4,5 W11.81" x D2.17" x H1.77"	1 pcs. W32 x D7.5 x H6.5   0.35 kg1 box   1 pcs.		790,00
	2 OUTLETS + 1 DOUBLE USB	W30 x D5,5 x H4,5 W11.81" x D2.17" x H1.77"	1 pcs. W32 x D7.5 x H6.5   0.35 kg1 box   1 pcs.		1.250,00
	2 OUTLETS + 1 CUSTOMER MODULE W/2 OUTLET	W30 x D5,5 x H4,5 W11.81" x D2.17" x H1.77"	1 pcs. W32 x D7.5 x H6.5   0.35 kg1 box   1 pcs.		870,00

### PLUG TYPE G (UK++)

AE, BD, BH, BN, BT, BW, BZ, CY, DM, FK, GB, GD, GH, GI, GM, GY, HK, IE, IM, IQ, JO, KE, KH, KN, KW, LB, LC, LK, MM, MO, MT, MU, MV, MW, MY, NG, OM, PK, QA, SA, SB, SC, SG, SL, TZ, UG, VC, VU, YE, ZM, ZW

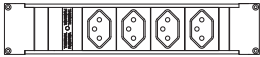
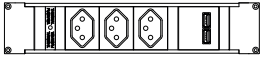
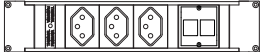
CH++   PLUG TYPE J	VARIANT	DIMENSION	BOX DIMENSION   WEIGHT	PACKAGING	PRICE
	4 OUTLETS	W30 x D5,5 x H4,5 W11.81" x D2.17" x H1.77"	1 pcs. W32 x D7.5 x H6.5   0.35 kg1 box   1 pcs.		790,00
	3 OUTLETS + 1 DOUBLE USB	W30 x D5,5 x H4,5 W11.81" x D2.17" x H1.77"	1 pcs. W32 x D7.5 x H6.5   0.35 kg1 box   1 pcs.		1.250,00
	3 OUTLETS + 1 CUSTOMER MODULE W/2 OUTLET	W30 x D5,5 x H4,5 W11.81" x D2.17" x H1.77"	1 pcs. W32 x D7.5 x H6.5   0.35 kg1 box   1 pcs.		870,00

### PLUG TYPE J (CH++)

CH, JO, LI, MG, MV, RW

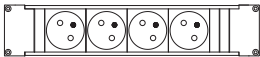
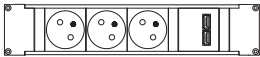
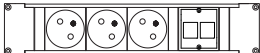
FR++   PLUG TYPE E	VARIANT	DIMENSION	BOX DIMENSION   WEIGHT	PACKAGING	PRICE
	4 OUTLETS	W30 x D5,5 x H4,5 W11.81" x D2.17" x H1.77"	1 pcs. W32 x D7.5 x H6.5   0.35 kg1 box   1 pcs.		790,00
	3 OUTLETS + 1 DOUBLE USB	W30 x D5,5 x H4,5 W11.81" x D2.17" x H1.77"	1 pcs. W32 x D7.5 x H6.5   0.35 kg1 box   1 pcs.		1.250,00
	3 OUTLETS + 1 CUSTOMER MODULE W/2 OUTLET	W30 x D5,5 x H4,5 W11.81" x D2.17" x H1.77"	1 pcs. W32 x D7.5 x H6.5   0.35 kg1 box   1 pcs.		870,00

### PLUG TYPE E (FR++)

BE, BF, BI, BJ, CD, CF, CG, CI, CM, CZ, DK, DJ, ET, FO, FR, GF, GL, GP, GQ, KM, LA, LR, MA, MC, MG, ML, MN, MQ, NE, PL, RE, SK, SN, SY, TD, TL, TN, VC

# 24% rabatt ska dras av på angivna priser

## STEP MODULES FOR CABLE MANAGEMENT

STEP BASE in plastic and STEP ALU in aluminium. NO STEP module power strip profile with 3 or 4 outlets. Customer outlets CAT6 or HDMI are sold separately. The custom module fits two customer outlets. The STEP Module fits into NO support bar or cable tray prepared for STEP module.

Stock item

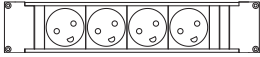
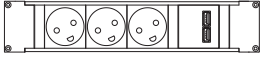
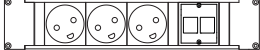
DK++   PLUG TYPE K	VARIANT	DIMENSION	BOX DIMENSION   WEIGHT	PACKAGING	PRICE
	4 OUTLETS	W30 x D5,5 x H4,5 W11.81" x D2.17" x H1.77"	1 pcs. W32 x D7.5 x H6.5   0.35 kg1 box   1 pcs.		790,00
	3 OUTLETS + 1 DOUBLE USB	W30 x D5,5 x H4,5 W11.81" x D2.17" x H1.77"	1 pcs. W32 x D7.5 x H6.5   0.35 kg1 box   1 pcs.		1.250,00
	3 OUTLETS + 1 CUSTOMER MODULE W/2 OUTLET	W30 x D5,5 x H4,5 W11.81" x D2.17" x H1.77"	1 pcs. W32 x D7.5 x H6.5   0.35 kg1 box   1 pcs.		870,00

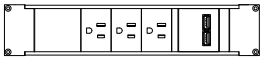
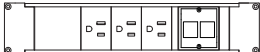

### PLUG TYPE K (DK++)

BD, DK, FO, GL, GN, MG, MV, SN, VC

US++   PLUG TYPE A	VARIANT	DIMENSION	BOX DIMENSION   WEIGHT	PACKAGING	PRICE
	4 OUTLETS	W30 x D5,5 x H4,5 W11.81" x D2.17" x H1.77"	1 pcs. W32 x D7.5 x H6.5   0.35 kg1 box   1 pcs.		790,00
	3 OUTLETS + 1 DOUBLE USB	W30 x D5,5 x H4,5 W11.81" x D2.17" x H1.77"	1 pcs. W32 x D7.5 x H6.5   0.35 kg1 box   1 pcs.		1.250,00
	3 OUTLETS + 1 CUSTOMER MODULE W/2 OUTLET	W30 x D5,5 x H4,5 W11.81" x D2.17" x H1.77"	1 pcs. W32 x D7.5 x H6.5   0.35 kg1 box   1 pcs.		870,00

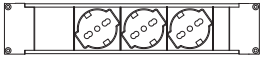
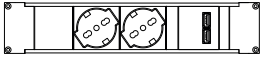

### PLUG TYPE A (US++)

AG, AI, AN (CW, SX, BQ), AS, AW, BB, BM, BO, BS, BZ, CA, CN, CO, CR, CU, DO, EC, FM, GT, GU, GY, HN, HT, JM, JP, KH, KN, KP, KY, LA, LB, LR, SV, MS, MV, MX, MY, NE, NI, PA, PE, PH, PR, PW, TC, TH, TT, TW, US, VC, VE, VG, VI, VN, YE

IT++   PLUG TYPE L	VARIANT	DIMENSION	BOX DIMENSION   WEIGHT	PACKAGING	PRICE
	3 OUTLETS	W30 x D5,5 x H4,5 W11.81" x D2.17" x H1.77"	1 pcs. W32 x D7.5 x H6.5   0.35 kg1 box   1 pcs.		790,00
	2 OUTLETS + 1 DOUBLE USB	W30 x D5,5 x H4,5 W11.81" x D2.17" x H1.77"	1 pcs. W32 x D7.5 x H6.5   0.35 kg1 box   1 pcs.		1.250,00
	2 OUTLETS + 1 CUSTOMER MODULE W/2 OUTLET	W30 x D5,5 x H4,5 W11.81" x D2.17" x H1.77"	1 pcs. W32 x D7.5 x H6.5   0.35 kg1 box   1 pcs.		870,00

### PLUG TYPE L (IT++)

CL, ER, ET, IT, MV, SM, SY, UY

ALL COUNTRIES	VARIANT	DIMENSION	BOX DIMENSION   WEIGHT	PACKAGING	PRICE
	CUSTOMER OUTLET CAT6	W2,5 x D5,5 x H4,5 W0.98" x D2.17" x H1.77"	1 pcs. W4.5 x D7.5 x H6.5   0.1 kg 1 box   1 pcs.		630,00
	CUSTOMER OUTLET HDMI	W2,5 x D5,5 x H4,5 W0.98" x D2.17" x H1.77"	1 pcs. W4.5 x D7.5 x H6.5   0.1 kg 1 box   1 pcs.		630,00

# 24% rabatt ska dras av på angivna priser

## STEP MODULE EXTENSION CABLE

L200 cm

Stock item

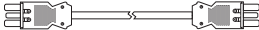
EXTENSION CABLE	VARIANT	DIMENSION	BOX DIMENSION   WEIGHT	PACKAGING	PRICE
	ALL COUNTRIES	W25 x D5 x H5 W9.84" x D1.97" x H1.97"	1 pcs. W27 x D7 x H7   0.5 kg	1 box   1 pcs.	300,00

## STEP MODULES SUPPLY CABLES

L500 cm

Stock item

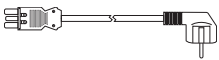
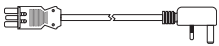
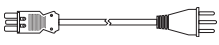
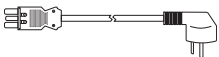
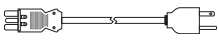
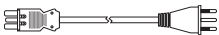
EXTENSION CABLE	VARIANT	DIMENSION	BOX DIMENSION   WEIGHT	PACKAGING	PRICE
	TYPE E (FR++) / TYPE F (CEE/GE++)	W25 x D5 x H5 W9.84" x D1.97" x H1.97"	1 pcs. W27 x D7 x H7   0.5 kg	1 box   1 pcs.	439,00
	TYPE G (UK++)	W25 x D5 x H5 W9.84" x D1.97" x H1.97"	1 pcs. W27 x D7 x H7   0.5 kg	1 box   1 pcs.	439,00
	TYPE J (CH++)	W25 x D5 x H5 W9.84" x D1.97" x H1.97"	1 pcs. W27 x D7 x H7   0.5 kg	1 box   1 pcs.	439,00
	TYPE K (DK++)	W25 x D5 x H5 W9.84" x D1.97" x H1.97"	1 pcs. W27 x D7 x H7   0.5 kg	1 box   1 pcs.	439,00
	TYPE A (US++)	W25 x D5 x H5 W9.84" x D1.97" x H1.97"	1 pcs. W27 x D7 x H7   0.5 kg	1 box   1 pcs.	1.400,00
	TYPE L (IT++)	W25 x D5 x H5 W9.84" x D1.97" x H1.97"	1 pcs. W27 x D7 x H7   0.5 kg	1 box   1 pcs.	439,00

# 24% rabatt ska dras av på angivna priser

## COVER FOR CABLE MANAGEMENT W. PEN HOLDER | MODULE SIZE 50 CM

Powder coated aluminium

Stock item

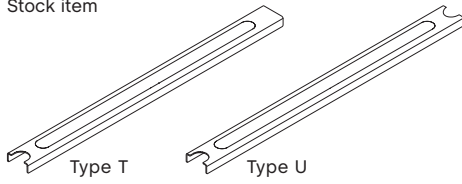

MATERIAL	COLOUR
Powder coated aluminium	Army Charcoal Light grey

VARIANT	DIMENSION	BOX DIMENSION   WEIGHT	PACKAGING	PRICE
END - TYPE T	W50 x D4 x H1 W19.69" x D1.57" x H0.39"	1 pcs. W52 x D42 x H3   0.4 kg	1 box   1 pcs.	130,00
MIDDLE - TYPE U	W50 x D4 x H1 W19.69" x D1.57" x H0.39"	1 pcs. W52 x D42 x H3   0.41 kg	1 box   1 pcs.	130,00

## COVER FOR CABLE MANAGEMENT | MODULE SIZE 25 CM

Powder coated aluminium

Stock item

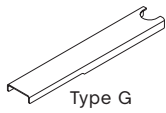

MATERIAL	COLOUR
Powder coated aluminium	Army Charcoal Light grey

VARIANT	DIMENSION	BOX DIMENSION   WEIGHT	PACKAGING	PRICE
END - TYPE G	W25 x D4 x H1 W9.84" x D1.57" x H0.39"	1 pcs. W27 x D42 x H3   0.1 kg	1 box   1 pcs.	219,00

## COVER FOR CABLE MANAGEMENT | MODULE SIZE 50 CM

Powder coated aluminium

Stock item

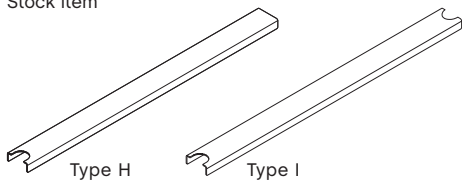

MATERIAL	COLOUR
Powder coated aluminium	Army Charcoal Light grey

VARIANT	DIMENSION	BOX DIMENSION   WEIGHT	PACKAGING	PRICE
END - TYPE H	W50 x D4 x H1 W19.69" x D1.57" x H0.39"	1 pcs. W52 x D42 x H3   0.18 kg	1 box   1 pcs.	219,00
MIDDLE - TYPE I	W50 x D4 x H1 W19.69" x D1.57" x H0.39"	1 pcs. W52 x D42 x H3   0.6 kg	1 box   1 pcs.	219,00

## COVER FOR PLUG AND PLAY | DOUBLE P&P CABLE MANAGEMENT | MODULE SIZE 25 CM

Powder coated aluminium

Stock item

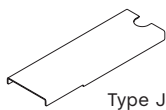

MATERIAL	COLOUR
Powder coated aluminium	Army Charcoal Light grey

VARIANT	DIMENSION	BOX DIMENSION   WEIGHT	PACKAGING	PRICE
END - TYPE J	W25 x D8 x H1 W9.84" x D3.15" x H0.39"	1 pcs. W27 x D82 x H3   0.2 kg	1 box   1 pcs.	299,00

# 24% rabatt ska dras av på angivna priser

## COVER FOR PLUG AND PLAY | DOUBLE P&P CABLE MANAGEMENT | MODULE SIZE 50 CM

Powder coated aluminium

Stock item

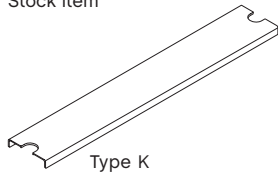

MATERIAL	COLOUR		
	Army	Charcoal	Light grey
Powder coated aluminium	•	•	•

VARIANT	DIMENSION	BOX DIMENSION   WEIGHT	PACKAGING	PRICE
MIDDLE - TYPE K	W50 x D8 x H1 W19.69" x D3.15" x H0.39"	1 pcs. W52 x D82 x H3   0.4 kg	1 box   1 pcs.	369,00

## FLIP COVER FOR PLUG AND PLAY | DOUBLE P&P CABLE MANAGEMENT | MODULE SIZE 50 CM | MIDDLE

Powder coated aluminium

Stock item

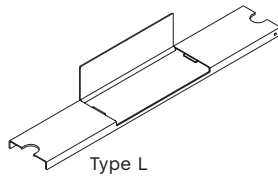

MATERIAL	COLOUR		
	Army	Charcoal	Light grey
Powder coated aluminium	•	•	•

VARIANT	DIMENSION	BOX DIMENSION   WEIGHT	PACKAGING	PRICE
MIDDLE - TYPE L	W50 x D8 x H1 W19.69" x D3.15" x H0.39"	1 pcs. W52 x D82 x H3   0.4 kg	1 box   1 pcs.	630,00

# 24% rabatt ska dras av på angivna priser

## NO COMBINATION 101

### ITEM LIST

- 1 x NO Shelf Bottom 100 cm
- 1 x NO Tray Top 100 cm
- 1 x NO Single Profile | Set of 4
- 1 x NO Wheels 34 mm Black | Set of 4

Stock item

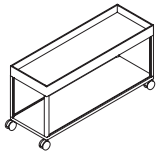

MATERIAL	COLOUR			
	Army	Charcoal	Light grey	Red
Powder coated aluminium	•	•	•	•

### VARIANT

W100

### DIMENSION

W100 x D34 x H49,9 cm  
W39.37" x D13.39" x H19.65"

### PRICE

5.380,00

## NO COMBINATION 102

### ITEM LIST

- 1 x NO Tray Top 150 cm
- 1 x NO Shelf Bottom 150 cm
- 1 x NO Single Profile | Set of 4
- 1 x NO Wheels 34 mm Black | Set of 4

Stock item

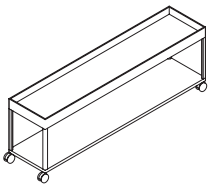

MATERIAL	COLOUR			
	Army	Charcoal	Light grey	Red
Powder coated aluminium	•	•	•	•

### VARIANT

W150

### DIMENSION

W150 x D34 x H49,9 cm  
W59.06" x D13.39" x H19.65"

### PRICE

7.090,00

## NO COMBINATION 103

### ITEM LIST

- 2 x NO Shelf Bottom 100 cm
- 2 x NO Tray Top 100 cm
- 1 x NO Single Profile | Set of 4
- 1 x NO Double Profile | Set of 2
- 2 x NO Wheels 34 mm Black | Set of 4

Stock item

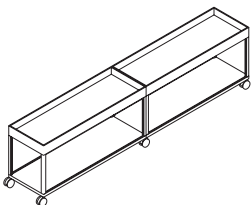

MATERIAL	COLOUR			
	Army	Charcoal	Light grey	Red
Powder coated aluminium	•	•	•	•

### VARIANT

W200

### DIMENSION

W200 x D34 x H49,9 cm  
W78.74" x D13.39" x H19.65"

### PRICE

10.760,00

# 24% rabatt ska dras av på angivna priser

## NO BENCH COMBINATION 100

### ITEM LIST

- 1 x NO Shelf Top 100 cm
- 1 x NO Shelf Bottom 100 cm
- 1 x NO Single Profile | Set of 4
- 1 x NO Benchtop 100 cm

Order produced

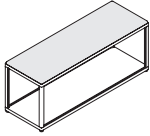

MATERIAL	COLOUR			
	Army	Charcoal	Light grey	Red
Powder coated aluminium	•	•	•	•

VARIANT	DIMENSION	FABRIC	PRICE
W100	W100 x D34 x H41,7 cm	Remix	7.080,00
	W39.37" x D13.39" x H16.42"	Surface By HAY	7.080,00
		Steelcut	7.230,00
		Steelcut Trio	7.230,00
		Canvas	7.390,00
		Sierra black leather	7.530,00
		Sense cognac leather	8.650,00

## NO BENCH COMBINATION 150

### ITEM LIST

- 1 x NO Shelf Top 150 cm
- 1 x NO Shelf Bottom 150 cm
- 1 x NO Single Profile | Set of 4
- 1 x NO Benchtop 150 cm

Order produced

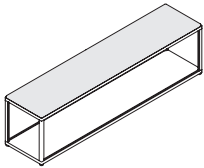

MATERIAL	COLOUR			
	Army	Charcoal	Light grey	Red
Powder coated aluminium	•	•	•	•

VARIANT	DIMENSION	FABRIC	PRICE
W150	W150 x D34 x H41,7 cm	Remix	9.960,00
	W59.06" x D13.39" x H16.42"	Surface By HAY	9.960,00
		Steelcut	10.190,00
		Steelcut Trio	10.190,00
		Canvas	10.440,00
		Sierra black leather	10.660,00
		Sense cognac leather	12.090,00

# 24% rabatt ska dras av på angivna priser

## NO COMBINATION 201

### ITEM LIST

- 1 x NO Shelf Top 100 cm
  - 1 x NO Shelf Middle 100 cm
  - 1 x NO Shelf Bottom 100 cm
  - 1 x NO Single Profile | Set of 4
  - 2 x NO Steel shelf 100 cm | Incl. pin 4 pcs. for adjustable side panels | Powder coated steel
  - 2 x NO Steel side panel double height 34 cm for adjustable shelf | Powder coated steel
  - 1 x NO Steel wall back panel double height 100 cm | Powder coated steel
  - 1 x NO Single Profile for double height | Set of 4
  - 1 x NO Steel sliding door double height 100 cm | Incl. handle, powder coated steel
- Please remember to specify wall- or floor safety brackets when ordering this combination.

Order produced

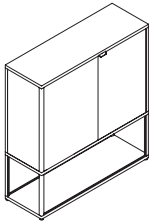

MATERIAL	COLOUR		
	Army	Charcoal	Light grey
Powder coated aluminium	•	•	•

VARIANT	DIMENSION	PRICE
W. WALL SAFETY BRACKET	W100 x D34 x H109,3 cm W39.37" x D13.39" x H43.03"	16.410,00
W. FLOOR SAFETY BRACKET	W100 x D34 x H109,3 cm W39.37" x D13.39" x H43.03"	16.660,00

## NO COMBINATION 202

### ITEM LIST

- 1 x NO Shelf Top 150 cm
- 1 x NO Shelf Middle 150 cm
- 1 x NO Shelf Bottom 150 cm
- 2 x NO Single Profile | Set of 4

Stock item

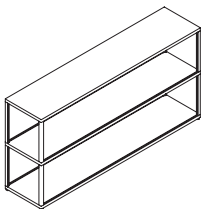

MATERIAL	COLOUR			
	Army	Charcoal	Light grey	Red
Powder coated aluminium	•	•	•	•

VARIANT	DIMENSION	PRICE
W150	W150 x D34 cm   x H74 cm W59.06" x D13.39" x H29.13"	10.130,00



# 24% rabatt ska dras av på angivna priser

## NO COMBINATION 203

### ITEM LIST

- 2 x NO Shelf Middle 100 cm
- 2 x NO Shelf Bottom 100 cm
- 2 x NO Tray Top 100 cm
- 2 x NO Single Profile | Set of 4
- 2 x NO Double Profile | Set of 2
- 4 x NO Steel side panel 34 cm | Powder coated steel
- 2 x NO Steel back panel 100 cm | Powder coated steel
- 2 x NO Steel sliding door 100 cm | Incl. handle, powder coated steel

Order produced

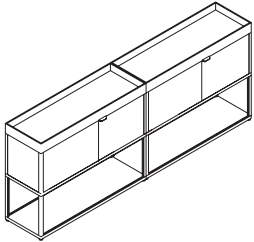

MATERIAL	COLOUR		
	Army	Charcoal	Light grey
Powder coated aluminium	•	•	•

VARIANT	DIMENSION	PRICE
W200	W200 x D34 x H79,7 cm W78.74" x D13.39" x H31.38"	22.880,00

## NO COMBINATION 204

### ITEM LIST

- 1 x NO Shelf Middle 100 cm
  - 1 x NO Shelf Bottom 100 cm
  - 1 x NO Tray Top 100 cm
  - 1 x NO Single Profile | Set of 4
  - 2 x NO Steel side panel double height 34 cm | For adjustable shelf powder coated steel
  - 1 x NO Steel back panel double height 100 cm | Powder coated steel
  - 1 x NO Single Profile for double height | Set of 4
  - 2 x NO Steel shelf 100 cm | Incl. pin 4 pcs. for adjustable side panels powder coated steel
  - 1 x NO Steel sliding door double height 100 cm | Incl. handle powder coated steel
- Please remember to specify wall- or floor safety brackets when ordering this combination.

Order produced

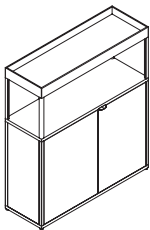

MATERIAL	COLOUR		
	Army	Charcoal	Light grey
Powder coated aluminium	•	•	•

VARIANT	DIMENSION	PRICE
W. WALL SAFETY BRACKET	W100 x D34 x H115 cm W39.37" x D13.39" x H45.28"	16.560,00
W. FLOOR SAFETY BRACKET	W100 x D34 x H115 cm W39.37" x D13.39" x H45.28"	16.810,00

# 24% rabatt ska dras av på angivna priser

## NO COMBINATION 205

### ITEM LIST

- 1 x NO Shelf Top 100 cm
  - 1 x NO Shelf Middle 100 cm
  - 1 x NO Shelf Bottom 100 cm
  - 1 x NO High drawer incl. Mounting set 100 cm
  - 2 x NO Steel Side panel 34 cm
  - 1 x NO Steel Back panel 100 cm
  - 2 x NO Single profile | Set of 4
- Please remember to specify wall- or floor safety brackets when ordering this combination.

Order produced

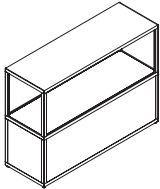

MATERIAL	COLOUR		
	Army	Charcoal	Light grey
Powder coated aluminium	•	•	•

VARIANT	DIMENSION	PRICE
W. WALL SAFETY BRACKET	W100 x D34 cm x H74 cm W39,37" x D13.39" x H29.13"	14.790,00
W. FLOOR SAFETY BRACKET	W100 x D34 cm x H74 cm W39,37" x D13.39" x H29.13"	16.830,00

## NO COMBINATION 301

### ITEM LIST

- 1 x NO Shelf Top 100 cm
  - 2 x NO Shelf Middle 100 cm
  - 1 x NO Shelf Bottom 100 cm
  - 3 x NO Single Profile | Set of 4
- Please remember to specify wall- or floor safety brackets when ordering this combination.

Stock item

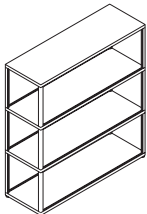

MATERIAL	COLOUR			
	Army	Charcoal	Light grey	Red
Powder coated aluminium	•	•	•	•

VARIANT	DIMENSION	PRICE
W. WALL SAFETY BRACKET	W100 x D34 x H109,3 cm W39.37" x D13.39" x H43.03"	10.200,00
W. FLOOR SAFETY BRACKET	W100 x D34 x H109,3 cm W39.37" x D13.39" x H43.03"	10.450,00

# 24% rabatt ska dras av på angivna priser

## NO COMBINATION 303

### ITEM LIST

- 2 x NO Shelf Middle 100 cm
- 1 x NO Shelf Bottom 100 cm
- 1 x NO Tray Top 100 cm
- 3 x NO Single Profile | Set of 4

Please remember to specify wall- or floor safety brackets when ordering this combination.

Stock item

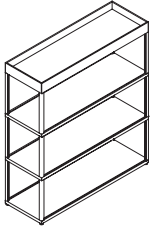

MATERIAL	COLOUR			
	Army	Charcoal	Light grey	Red
Powder coated aluminium	•	•	•	•

VARIANT	DIMENSION	PRICE
W. WALL SAFETY BRACKET	W100 x D34 x H115 cm W39.37" x D13.39" x H45.28"	10.350,00
W. FLOOR SAFETY BRACKET	W100 x D34 x H115 cm W39.37" x D13.39" x H45.28"	10.600,00

## NO COMBINATION 401

### ITEM LIST

- 1 x NO Wooden panel and door set incl. handle 100 cm
- 1 x NO Shelf Top 100 cm
- 3 x NO Shelf Middle 100 cm
- 1 x NO Shelf Bottom 100 cm
- 4 x NO Single Profile | Set of 4

Please remember to specify floor safety brackets when ordering this combination.

Order produced

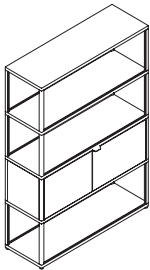

MATERIAL	COLOUR			
	Army	Charcoal	Light grey	Red
Powder coated aluminium	•	•	•	•

VARIANT	DIMENSION	PRICE
W. WALL SAFETY BRACKET	W100 x D34 x H144,6 cm W39.37" x D13.39" x H56.93"	15.940,00
W. FLOOR SAFETY BRACKET	W100 x D34 x H144,6 cm W39.37" x D13.39" x H56.93"	16.190,00

# 24% rabatt ska dras av på angivna priser

## NO COMBINATION 501

### ITEM LIST

- 1 x NO Shelf Top 100 cm
- 4 x NO Shelf Middle 100 cm
- 1 x NO Shelf Bottom 100 cm
- 5 x NO Single Profile | Set of 4

Please remember to specify wall- or floor safety brackets when ordering this combination.

Stock item

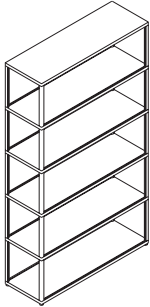

MATERIAL	COLOUR		
	Army	Charcoal	Light grey
Powder coated aluminium	•	•	•

VARIANT	DIMENSION	PRICE
W. WALL SAFETY BRACKET	W100 x D34 x H179,9 cm W39.37" x D13.39" x H70.83	15.420,00
W. FLOOR SAFETY BRACKET	W100 x D34 x H179,9 cm W39.37" x D13.39" x H70.83	15.670,00

## NO COMBINATION 502

### ITEM LIST

- 1 x NO Shelf Top 100 cm
- 4 x NO Shelf Middle 100 cm
- 1 x NO Shelf Bottom 100 cm
- 5 x NO Single Profile | Set of 4
- 2 x NO Steel side panel 34 cm | Powder coated steel
- 1 x NO Steel back panel 100 cm | Powder coated steel
- 1 x NO Steel sliding door 100 cm | Incl. handle powder coated steel

Please remember to specify wall- or floor safety brackets when ordering this combination.

Order produced

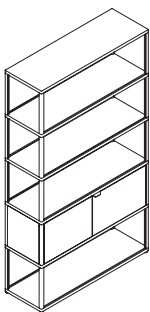

MATERIAL	COLOUR		
	Army	Charcoal	Light grey
Powder coated aluminium	•	•	•

VARIANT	DIMENSION	PRICE
W. WALL SAFETY BRACKET	W100 x D34 cm   x H179,9 cm W39.37" x D13.39" x H70,83"	19.370,00
W. FLOOR SAFETY BRACKET	W100 x D34 cm   x H179,9 cm W39.37" x D13.39" x H70,83"	19.620,00

# 24% rabatt ska dras av på angivna priser

## NO COMBINATION 701

### ITEM LIST

- 1 x NO Shelf Top 100 cm
- 6 x NO Shelf Middle 100 cm
- 1 x NO Shelf Bottom 100 cm
- 7 x NO Single Profile | Set of 4

Please remember to specify wall- or floor safety brackets when ordering this combination.

Stock item

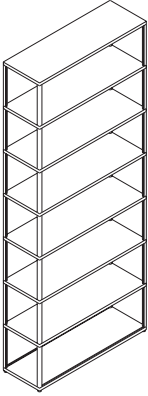

MATERIAL	COLOUR			
	Army	Charcoal	Light grey	Red
Powder coated aluminium	•	•	•	•

VARIANT	DIMENSION	PRICE
W. WALL SAFETY BRACKET	W100 x D34 x H250,5 cm W39.37" x D13.39" x H98.62"	20.640,00
W. FLOOR SAFETY BRACKET	W100 x D34 x H250,5 cm W39.37" x D13.39" x H98.62"	20.890,00

## NO COMBINATION 702

### ITEM LIST

- 1 x NO Shelf Top 150 cm
  - 6 x NO Shelf Middle 150 cm
  - 1 x NO Shelf Bottom 150 cm
  - 7 x NO Single Profile | Set of 4
  - 4 x NO Steel side panel 34 cm | Powder coated steel
  - 2 x NO Steel back panel 150 cm | Powder coated steel
  - 2 x NO Steel sliding door 150 cm | Incl. handle, powder coated steel
- Please remember to specify wall- or floor safety brackets when ordering this combination.

Order produced

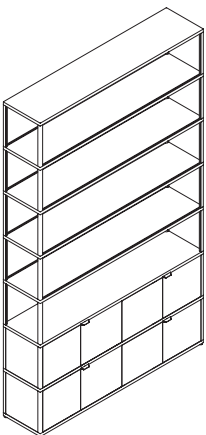

MATERIAL	COLOUR			
	Army	Charcoal	Light grey	Red
Powder coated aluminium	•	•	•	•

VARIANT	DIMENSION	PRICE
W. WALL SAFETY BRACKET	W150 x D34 x H250,5 cm W59.06" x D13.39" x H98.62"	39.460,00
W. FLOOR SAFETY BRACKET	W150 x D34 x H250,5 cm W59.06" x D13.39" x H98.62"	39.710,00

# 24% rabatt ska dras av på angivna priser

## NO TABLE COMBINATION 401

### ITEM LIST

- 1 x NO Legs H74 Army | Set of 2 w. 2 flat knots
  - 1 x NO Table Connector Front 20 cm | Set of 2
  - 1 x NO Shelf Top 100 cm
  - 3 x NO Shelf Middle 100 cm
  - 1 x NO Shelf Bottom 100 cm
  - 3 x NO Single Profile | Set of 4
  - 2 x NO Steel side panel double height 34 cm | For adjustable shelf | Powder coated steel
  - 1 x NO Steel table back panel double height 100 cm | Powder coated steel
  - 1 x NO Single Profile for double height | Set of 4
  - 2 x NO Steel shelf 100 cm | Incl. pin 4 pcs. for adjustable side panels, powder coated steel
  - 1 x NO Steel sliding door double height 100 cm | Incl. handle, powder coated steel
  - 1 x NO Frame L100 x W100 F2
  - 1 x NO Tabletop 100x100 L994 x W994 B
- Please remember to specify wall- or floor safety brackets when ordering this combination.

Order produced

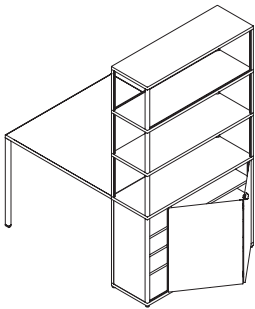

MATERIAL	COLOUR		
	Army	Charcoal	Light grey
Powder coated aluminium	•	•	•

### VARIANT

W. FLOOR SAFETY  
BRACKET

### DIMENSION

W100 x D134 x H179,9 cm  
W39.37" x D52.76" x H70.83"

### PRICE

34.730,00

# 24% rabatt ska dras av på angivna priser

## COLOURS & MATERIALS

### SHELVING SYSTEM & TABLE FRAME

Powder-coated aluminium & steel



ARMY

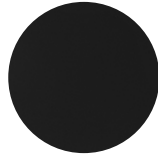

CHARCOAL

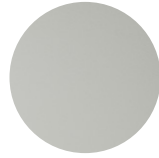

LIGHT GREY

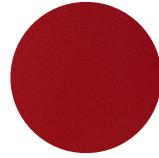

RED

\*Not available for table frame and steel

### TABLETOPS

Linoleum



GREEN

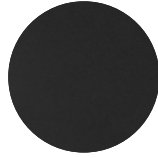

DARK GREY



GREY



CLOUD GREY

Veneer



WATER-BASED LACQUERED OAK

### WOODEN PANELS AND DOORS

Veneer



UNTREATED OAK VENEER



UNTREATED ASH VENEER

### TEXTILE PANELS, TABLE SCREENS AND BENCHTOP

All textile colours available from each of the selected collections

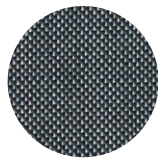

SURFACE BY HAY

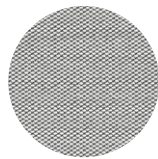

STEELCUT TRIO

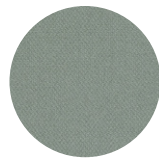

STEELCUT

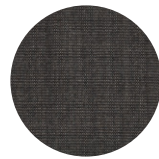

CANVAS

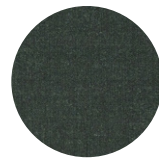

REMIX



LEATHER SENSE COGNAC  
(Benchtop only)



LEATHER SIERRA BLACK S11001  
(Benchtop only)

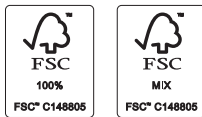

## FSC™ CERTIFICATION

HAY is FSC™ certified. FSC (Forest Stewardship Council) is an international non-profit organisation and a labelling system for wood and paper that originate from certified forestry and other controlled sources. HAY's FSC license code is: FSC™-C148805. Only products that are identified as FSC™ are made from FSC-certified materials.

## ECOLABELS

The Nordic Swan Ecolabel is the official ecolabel in the Nordics and the EU Ecolabel is the official ecolabel in Europe. They work to reduce the overall environmental impact from production and consumption. To ensure maximum environmental impact, the Nordic Swan Ecolabel and the EU Ecolabel take an entire life cycle approach and look at the full product journey. This means that the ecolabels evaluate the environmental impact of the specific product type and set requirements in all relevant stages of the product life cycle – from raw materials, production and use, to waste, re-use and recycling.

Both the Nordic Swan Ecolabel and the EU Ecolabel promote circular economy and are powerful tools for securing a sustainable future. HAY supports this by developing sustainable, quality products that are designed to last. All constructed with the focus on the disassembly and recycling of the product at the end of its life.

## SUSTAINABILITY

HAY focuses on developing long-lasting products that minimise our environmental impact. We optimise the use of sustainable materials such as recycled materials, FSC-certified wood and water-based lacquer, with a growing number of eco-certified products. We have strict regulatory requirements, and the majority of our products are tested to comply with international standards for strength, durability and safety.

[LINK TO ENVIRONMENTAL PROFILE](#)

## DOWNLOADS

Packshots and lifestyle photos, 2D / 3D files, care and maintenance, instructions, test certificates, product fact sheets, and product presentations are available in our Image Bank at hay.com.

[LINK TO IMAGE BANK](#)



24% rabatt ska dras av på angivna priser

Stockholm  
Luleå  
Sundsvall

Göteborg  
Gävle

Malmö  
Hedemora

Uppsala  
Edsbyn

Helsingborg  
Jönköping

Umeå  
Norrköping

**SENAB**  
*space for big ideas*